

S9086-UU-STM-010/CH-613R3

REVISION 3

NAVAL SHIPS' TECHNICAL MANUAL
CHAPTER 613
**WIRE AND FIBER ROPE AND
RIGGING**

THIS CHAPTER SUPERSEDES CHAPTER 613 DATED 1 MAY 1995

DISTRIBUTION STATEMENT A: APPROVED FOR PUBLIC RELEASE. DISTRIBUTION IS UNLIMITED.

PUBLISHED BY DIRECTION OF COMMANDER, NAVAL SEA SYSTEMS COMMAND.

30 AUG 1999

S9086-UU-STM-010/CH-613R3

NAVSEA TECHNICAL MANUAL CERTIFICATION SHEET						1 of 1	
Certification Applies to: New Manual		<input type="checkbox"/>	Revision	<input checked="" type="checkbox"/>	Change	<input type="checkbox"/>	
Applicable TMINS/Pub. No.	<u>S9086-UU-STM-010/CH-613R3</u>						
Publication Date (Mo, Da, Yr)	<u>August 30, 1999</u>						
Title: <u>NSTM Chapter 613, Wire and Fiber Rope and Rigging</u>							
TMCR/TMSR/Specification No: _____							
CHANGES AND REVISIONS:							
Purpose: <u>Side bars in the outside margin indicate changes since the last revision.</u>							

Equipment Alteration Numbers Incorporated: _____							
TMDER/ACN Numbers Incorporated: _____							
<i>Continue on reverse side or add pages as needed.</i>							
CERTIFICATION STATEMENT							
This is to certify that responsible NAVSEA activities have reviewed the above identified document for acquisition compliance, technical coverage, and printing quality. This form is for internal NAVSEA management use only, and does not imply contractual approval or acceptance of the technical manual by the Government, nor relieve the contractor of any responsibility for delivering the technical manual in accordance with the contract requirement.							
Authority	Name	Signature	Organization	Code	Date		
Acquisition							
Technical	D. Newman	<i>D. Newman</i>	Naval Sea Systems Command	03P8	8/30/99		
Printing Release	Digital Media Publishing						

TITLE-2

TABLE OF CONTENTS

Chapter/Paragraph	Page
613 WIRE AND FIBER ROPE AND RIGGING	613-1
SECTION 1. WIRE ROPE	613-1
613-1.1 FABRICATION	613-1
613-1.1.1 GENERAL.	613-1
613-1.1.2 COMPLEXITY.	613-1
613-1.2 PARTS	613-1
613-1.2.1 GENERAL.	613-1
613-1.2.2 CORE TYPE.	613-1
613-1.2.3 CORE MATERIAL.	613-2
613-1.2.4 CHOICE OF CORE.	613-2
613-1.3 LAYS	613-2
613-1.3.1 GENERAL.	613-2
613-1.3.2 RIGHT LAY OR RIGHT-HAND HELIX.	613-3
613-1.3.3 LEFT LAY OR LEFT-HAND HELIX.	613-3
613-1.3.4 REGULAR LAY.	613-3
613-1.3.5 LANG LAY.	613-3
613-1.3.6 PITCH OR LENGTH OF LAY.	613-3
613-1.4 SIZE	613-3
613-1.5 CONSTRUCTION.	613-4
613-1.5.1 GENERAL.	613-4
613-1.5.2 SEALE CONSTRUCTION.	613-5
613-1.5.3 WARRINGTON CONSTRUCTION.	613-5
613-1.5.4 FILLER WIRE.	613-5
613-1.5.5 FLATTENED STRAND.	613-5
613-1.5.6 SPRING LAY.	613-5
613-1.6 PREFORMED WIRE ROPE	613-5
613-1.7 ZINC-COATED OR WIRE ROPE	613-6
613-1.8 CONDITIONS OF USE	613-6
613-1.8.1 CHARACTERISTICS.	613-6
613-1.8.2 USES.	613-6
613-1.8.2.1 6 by 7.	613-6
613-1.8.2.2 6 by 12.	613-6
613-1.8.2.3 6 by 19.	613-6
613-1.8.2.4 6 by 24.	613-7
613-1.8.2.5 6 by 37.	613-7
613-1.8.2.6 6 by 3 by 19, Spring Lay Rope.	613-7
613-1.8.3 STRENGTH.	613-7

TABLE OF CONTENTS - Continued

Chapter/Paragraph	Page
613-1.8.4	FACTOR OF SAFETY. 613-8
613-1.8.5	FITTINGS. 613-8
613-1.8.5.1	Test. 613-10
613-1.8.5.2	Marking. 613-10
613-1.8.5.3	System Applicability. 613-10
613-1.9	CARE AND PRESERVATION 613-10
613-1.9.1	STORAGE. 613-10
613-1.9.2	UNCOILING AND UNREELING. 613-10
613-1.9.3	KINKING AND RESULTING ROPE DAMAGE. 613-12
613-1.9.4	DRUM WINDING. 613-13
613-1.10	INSPECTION, REPLACEMENT, AND LUBRICATION 613-15
613-1.10.1	GENERAL. 613-15
613-1.10.2	INSPECTION. 613-15
613-1.10.2.1	External Inspection. 613-15
613-1.10.2.2	Internal Inspection. 613-16
613-1.10.3	GENERAL. 613-16
613-1.10.4	LUBRICATION. 613-16
613-1.11	SPLICING AND TERMINATING 613-17
613-1.11.1	SEIZING. 613-17
613-1.11.1.1	Temporary Seizing. 613-18
613-1.11.1.2	Permanent Seizing. 613-19
613-1.11.1.3	Electrical Sealing. 613-20
613-1.11.2	POURED ZINC SOCKET. 613-20
613-1.11.2.1	Need for Qualified Preinstallation Process Control. 613-20
613-1.11.2.2	Qualification Requirement. 613-20
613-1.11.2.3	Steel Wire Rope with Steel Socket. 613-21
613-1.11.2.4	In-Service Sockets. 613-29
613-1.11.2.5	System Applicability. 613-29
613-1.11.2.6	Reuse of Poured Sockets. 613-29
613-1.11.2.7	BRONZE WIRE ROPE WITH BRASS OR BRONZE SOCKET. 613-29
613-1.11.3	POURED RESIN SOCKET. 613-29
613-1.11.3.1	Need for Qualified Assembly Process Control. 613-29
613-1.11.3.2	Qualification Requirement. 613-29
613-1.11.3.3	Steel Wire Rope with WIRELOCK or SOCKETFAST Poured Resin Spelter Socket. 613-30
613-1.11.3.4	In-Service Sockets. 613-43
613-1.11.3.5	System Applicability 613-43
613-1.11.3.6	Re-use of Poured Resin Socket. 613-43
613-1.11.4	FIEGE-TYPE (THREADED, COMPRESSION) WIRE ROPE CONNECTORS. 613-44
613-1.11.4.1	Parts. 613-44
613-1.11.4.2	Installation. 613-44
613-1.11.5	WIRE ROPE CLIPS. 613-47

TABLE OF CONTENTS - Continued

Chapter/Paragraph	Page
613-1.11.5.1 Installation.	613-47
613-1.11.6 SWAGING.	613-50
613-1.11.6.1 Qualified Personnel.	613-50
613-1.11.6.2 Swaging Qualification.	613-50
613-1.11.6.3 Installation.	613-50
613-1.11.7 SPLICING.	613-51
613-1.11.7.1 Types of Splicing.	613-51
613-1.11.7.2 Rope Length Requirements.	613-51
613-1.11.7.3 Short Splice.	613-51
613-1.11.7.4 Long Splice.	613-52
613-1.11.7.5 Independent Wire Rope Core Splice	613-58
613-1.11.7.6 IWRC Splicing Procedures.	613-58
613-1.11.7.7 Eye Splice.	613-61
613-1.11.7.8 Liverpool Splice.	613-61
613-1.11.7.9 Lock-Tuck Splice.	613-63
613-1.11.7.10 Flemish Eye Splice (Molly Hogan).	613-65
SECTION 2. FIBER ROPE	613-67
613-2.1 INTRODUCTION	613-67
613-2.1.1 GENERAL.	613-67
613-2.1.2 COMPLEXITY.	613-67
613-2.2 FIBER ROPE IDENTIFICATION.	613-67
613-2.2.1 FIBERS.	613-67
613-2.2.2 LARGE ROPES.	613-67
613-2.2.3 MANILA AND SISAL ROPES.	613-67
613-2.2.4 SYNTHETIC ROPE.	613-67
613-2.3 FIBER ROPE CONSTRUCTION	613-67
613-2.3.1 TWISTED FIBER ROPES.	613-67
613-2.3.2 LARGE LAID ROPES.	613-68
613-2.3.3 PLAIN-LAID ROPES.	613-68
613-2.3.4 CABLE-LAID ROPES.	613-68
613-2.3.5 PLAITED ROPES.	613-68
613-2.3.6 BRAIDED ROPES.	613-70
613-2.3.7 DOUBLE BRAIDED ROPES.	613-70
613-2.3.8 SMALL CORDAGE ROPES.	613-71
613-2.3.9 MARLINE.	613-72
613-2.3.10 POLYETHYLENE ROPE.	613-72
613-2.3.11 SIGNAL HAYYARDS.	613-72
613-2.4 PRECAUTIONS AND TECHNIQUES FOR THE USES OF ROPES	613-72
613-2.4.1 GENERAL.	613-72
613-2.4.2 UNCOILING AND UNREELING.	613-72
613-2.4.2.1 Uncoiling Natural Fiber-Laid Ropes.	613-72
613-2.4.2.2 Uncoiling Synthetic Fiber-Laid Ropes.	613-72

TABLE OF CONTENTS - Continued

Chapter/Paragraph	Page
613-2.4.2.3 Unreeling Synthetic Fiber Ropes.	613-73
613-2.4.2.4 Unwinding Aramid Lines.	613-73
613-2.4.3 RECOILING AND REREELING.	613-73
613-2.4.4 ELONGATION AND PERMANENT STRETCH.	613-73
613-2.4.4.1 Natural Fiber Ropes.	613-73
613-2.4.4.2 Synthetic Fiber Ropes.	613-73
613-2.4.5 SHRINKAGE AND SWELLING	613-73
613-2.4.5.1 Natural Fiber Ropes.	613-73
613-2.4.5.2 Synthetic Fiber Ropes.	613-74
613-2.5 PRECAUTIONS AND TECHNIQUES FOR THE USES OF ROPES	613-74
613-2.5.1 GENERAL.	613-74
613-2.5.2 EYE SPLICE IN PLAIN-LAID ROPE.	613-74
613-2.5.2.1 Natural Fiber Ropes.	613-74
613-2.5.3 EYE SPLICE IN 4-STRAND ARAMID FIBER ROPE.	613-75
613-2.5.4 EYE SPLICE IN PLAITED ROPE.	613-75
613-2.5.5 EYE SPLICE IN DOUBLE BRAIDED ROPE.	613-77
613-2.5.6 SHORT SPLICE.	613-77
613-2.5.9 LONG SPLICE.	613-80
613-2.5.10 LONG SPLICE OF PLAIN-LAID ROPES.	613-80
613-2.5.11 LONG SPLICE OF PLAITED ROPE.	613-81
613-2.5.12 LONG SPLICE OF DOUBLE-BRAIDED ROPE.	613-85
613-2.5.13 THROAT SEIZING.	613-85
613-2.6 WHIPPING AND SEALING	613-87
613-2.6.1 WHIPPING.	613-87
613-2.6.2 SEALING.	613-87
613-2.7 EFFECTS OF SECURING ROPES	613-88
613-2.7.2 GENERAL.	613-88
613-2.7.2 KNOTS.	613-88
613-2.7.3 ROUND TURNS.	613-88
613-2.7.4 FIGURE-EIGHT BENDS.	613-88
613-2.7.5 OVERRIDING TURNS.	613-88
613-2.8 EXTENDING ROPE'S SERVICE LIFE	613-89
613-2.8.1 GENERAL.	613-89
613-2.8.2 DAMAGING CONDITIONS.	613-89
613-2.8.2.1 Excessive Pull.	613-89
613-2.8.2.2 Surface Abrasion.	613-93
613-2.8.2.3 Chafing Gear.	613-93
613-2.8.2.4 Deck Fittings.	613-93
613-2.8.2.5 Gritty Material.	613-93
613-2.8.2.6 Effects of a Freezing Environment.	613-93
613-2.8.2.7 Sharp Edges.	613-93
613-2.8.2.8 Shearing.	613-93
613-2.8.2.9 Rope Kinks and Cockles.	613-93

TABLE OF CONTENTS - Continued

Chapter/Paragraph	Page
613-2.8.2.10 Bending.	613-94
613-2.8.2.11 Drag.	613-94
613-2.9 EFFECT OF AGING ON FIBER ROPES	613-94
613-2.9.1 NATURAL FIBER ROPES.	613-94
613-2.9.2 SYNTHETIC FIBER ROPES.	613-94
613-2.10 ROPE REPLACEMENT AND USAGE	613-94
613-2.11 ROPE STOWAGE	613-95
613-2.11.1 GENERAL.	613-95
613-2.11.2 NATURAL FIBER ROPE STOWAGE.	613-95
613-2.11.3 SYNTHETIC FIBER ROPE STOWAGE.	613-95
613-2.12 ROPE-USE PRECAUTIONS, INSTRUCTIONS, AND INSPECTIONS	613-95
613-2.12.1 GENERAL.	613-95
613-2.12.2 PRACTICES TO AVOID.	613-95
613-2.12.3 INSPECTING NATURAL FIBER ROPES FOR DAMAGE.	613-96
613-2.12.4 SYNTHETIC ROPES.	613-97
613-2.12.4.1 Advantages of Synthetic Ropes.	613-97
613-2.12.4.2 Specifications.	613-97
613-2.12.4.3 Maintenance.	613-97
613-2.13 SYNTHETIC ROPE; GENERAL USAGE	613-98
613-2.13.1 GENERAL.	613-98
613-2.13.2 HEAVY LOADS.	613-98
613-2.13.3 SYNTHETIC ROPE STRETCH.	613-98
613-2.13.3.1 Tattle-tales.	613-98
613-2.13.3.2 Aramid Line Failure Indicators.	613-99
613-2.13.4 MOORING LINES.	613-99
613-2.13.5 ELONGATION AND PAIRING OF DISSIMILAR ROPES.	613-101
613-2.13.6 SYNTHETIC ROPE STOPPERS.	613-101
613-2.13.7 COILING.	613-101
613-2.13.8 REDUCING ABRASION AND MINIMIZING SURGING.	613-101
613-2.13.9 CAPSTANS.	613-101
613-2.13.10 TOWING END FITTINGS.	613-101
613-2.13.11 SPECIAL THIMBLES.	613-102
613-2.13.12 THIMBLES AND SHACKLES.	613-102
613-2.13.13 THIMBLE USAGE.	613-102
613-2.14 PRECAUTIONS FOR USING SYNTHETIC FIBER ROPES	613-103
613-2.14.1 GENERAL.	613-103
613-2.14.2 SINGLE-PART HANDLING.	613-103
613-2.14.3 ROPE ELONGATION.	613-103
613-2.14.4 REBONDING OF BITT AND CAPSTAN LINES.	613-103
613-2.14.5 SURGING ON BITT AND CLEAT LINES.	613-103
613-2.14.6 EASING-OUT AND CHECKING LINES.	613-104

TABLE OF CONTENTS - Continued

Chapter/Paragraph	Page
613-2.14.7 MAKING A SIDE TOW HITCH.613-104
613-2.14.8 DOUBLING-UP SYNTHETIC MOORING LINES.613-104
613-2.14.9 STOPPER.613-105
613-2.14.10 SYNTHETIC FIBER ROPE'S LIFE EXPECTANCY.613-105
613-2.15 CRITERIA FOR ESTIMATING USED ROPE SERVICEABILITY613-105
613-2.15.1 GENERAL.613-105
613-2.15.2 ROPE WEAR.613-105
613-2.15.3 BREAKING STRENGTH LOSS.613-105
613-2.15.4 CHAFING.613-105
613-2.15.5 STRETCHOUT.613-105
613-2.15.6 CUTTING.613-105
613-2.15.7 COCKLING.613-106
613-2.15.8 RUST.613-106
613-2.15.9 CUMULATIVE EFFECT OF SERVICEABILITY FACTORS.613-107
613-2.15.10 INSPECTION GUIDELINES.613-107
SECTION 3. RIGGING613-107
613-3.1 INTRODUCTION613-107
613-3.2 STANDING RIGGING REQUIREMENTS613-108
613-3.2.1 GENERAL.613-108
613-3.2.2 SPLICING AND SERVING.613-108
613-3.2.3 PREPARATION.613-108
613-3.2.4 WORMING.613-108
613-3.2.5 PARCELING.613-108
613-3.2.6 SERVING.613-108
613-3.2.7 DOUBLE SERVING.613-108
613-3.3 INSTALLATION613-108
613-3.4 ADJUSTMENT613-108
613-3.5 INSULATORS613-109
613-3.6 GROUNDING613-109
613-3.7 CHARRING OF WOOD613-109
613-3.8 INSULATION AND GROUNDING613-109
613-3.9 REFERENCES613-110

LIST OF TABLES

Table	Title	Page
613-1-1.	WIRE ROPE ACCEPTANCE BREAKING STRENGTH	613-9
613-1-2.	WIRE ROPE ALLOWABLE DIAMETER REDUCTION	613-16
613-1-3.	SEIZINGS FOR WIRE ROPE	613-18
613-1-4.	TEMPERATURE CONDITIONS	613-24
613-1-5A.	Compound Quantities for WIRELOCK	613-37
613-1-6A.	Compound Quantities for SOCKETFAST	613-40
613-1-5.	MINIMUM NUMBER OF CLIPS REQUIRED	613-49
613-1-6.	LENGTH OF UNLAYED ROPE REQUIRED	613-51
613-2-1.	FIBER ROPE SPECIFICATIONS	613-68
613-2-2.	SMALL CORDAGE SPECIFICATIONS	613-72
613-2-3.	STRANDED AND BRAIDED ROPE MINIMUM BREAKING STRENGTH (LBS)	613-90
613-2-4.	DIMENSIONS FOR TATTLE-TALE LINES	613-99
613-2-5.	SUBSTITUTION OF ARAMID ROPE FOR OTHER SYNTHETIC ROPES	613-100
613-2-6.	ROPE INSPECTION GUIDELINES	613-107

LIST OF ILLUSTRATIONS

Figure	Title	Page
613-1-1.	Wire Rope Construction	613-1
613-1-2.	Core Construction	613-2
613-1-3.	Wire Rope Lays	613-2
613-1-4.	Length of Rope Lays	613-3
613-1-5.	Measuring Wire Rope	613-4
613-1-6.	Common Wire Rope Construction, Examples	613-5
613-1-7.	Uncoiling Wire Rope	613-11
613-1-8.	Unreeling Wire Rope	613-12
613-1-9.	Improper Handling	613-12
613-1-10.	Wire Rope Loop	613-13
613-1-11.	Wire Rope Kink	613-13
613-1-12.	Kink Damage	613-13
613-1-13.	Overwind Reeving Attachment Point	613-14
613-1-14.	Underwind Reeving Attachment Point	613-15
613-1-15.	Seizing	613-18
613-1-16.	Seizing Iron	613-19
613-1-17.	Permanent Seizing	613-19
613-1-18.	Socket Pouring	613-22
613-1-19.	Level of Poured Zinc and Zinc Penetration	613-26
613-1-20.	Rotation of Socket	613-27
613-1-21.	Axial Movement of Socket	613-28
613-1-22A.	Seizing of Wire Rope.	613-31
613-1-23A.	Unlay of Wire Rope.	613-32
613-1-24A.	Properly Broomed Wire Rope.	613-33
613-1-25A.	Socket Properly Sealed with Fireclay.	613-35
613-1-26A.	Properly Positioned Socket with Wire Rope Ends Protruding.	613-36

LIST OF ILLUSTRATIONS - Continued

Figure	Title	Page
613-1-27A.	Proper Vessel and Wooden Paddle Used in Mixing.	613-38
613-1-28A.	Proper Mixing of the WIRELOCK Compound.	613-39
613-1-29A.	Mixing of the SOCKETFAST Catalyst to Resin Mixture.	613-41
613-1-30A.	Pouring of SOCKETFAST Compound into the Socket.	613-42
613-1-22.	Fiege-Type Electrolite (Threaded Compression) Assembly (Sheet 1 of 3)	613-45
613-1-22.	Fiege-Type Electrolite (Threaded Compression) Assembly (Sheet 2 of 3)	613-46
613-1-22.	Fiege-Type Electrolite (Threaded Compression) Assembly (Sheet 3 of 3)	613-47
613-1-23.	Clip Attachments	613-48
613-1-24.	Seizing Long Splice	613-52
613-1-25.	Strand Identification	613-52
613-1-26.	Relaying Strands	613-53
613-1-27.	Cutting Strand Length	613-53
613-1-28.	Binding the Long Splice	613-54
613-1-29.	Long Splice Tuck Points	613-55
613-1-30.	Preparing for Tuck	613-55
613-1-31.	Cutting the Core	613-56
613-1-32.	Removing the Core	613-57
613-1-33.	Laying in Strand	613-57
613-1-34.	Rope Ready for Tucking	613-57
613-1-35.	Finishing	613-58
613-1-36.	Butting IWRC Splice	613-59
613-1-37.	Initial Tuck Point	613-60
613-1-38.	IWRC Tuck Points	613-60
613-1-39.	Vice Position	613-60
613-1-40.	Finishing IWRC Splice	613-61
613-1-41.	Finished IWRC Splice	613-61

LIST OF ILLUSTRATIONS - Continued

Figure	Title	Page
613-1-42.	First Three Tucks of Liverpool Splice	613-62
613-1-43.	Strands Four, Five, and Six of Liverpool Splice	613-62
613-1-44.	Working the Strands of Liverpool Splice	613-63
613-1-45.	Lock-Tuck Splice	613-64
613-1-46.	Lock-Tuck Splice Completed	613-65
613-1-47.	Flemish Eye Splice (Molly Hogan)	613-66
613-2-1.	Synthetic Fiber Plain-Laid Rope	613-69
613-2-2.	Synthetic Fiber Cable-Laid Rope	613-69
613-2-3.	Plaited Rope	613-70
613-2-4.	Synthetic Fiber Double Braided Rope	613-71
613-2-5.	Fids Used for Splicing Double-Braided Line	613-71
613-2-6.	Eye Splice in Plain-Laid Rope	613-74
613-2-7.	Sailmaker's Eye Splice for 4-Strand Rope (Preferred Method)	613-75
613-2-8.	Eye Splice in Plaited Rope	613-76
613-2-9.	Extracting the Core from Double-Braided Rope	613-77
613-2-10.	Putting Cover Inside Core of Double-Braided Rope	613-77
613-2-11.	Reinserting Core Into Cover of Double-Braided Rope	613-78
613-2-12.	Double-Braided Rope Eye Splice	613-78
613-2-13.	Short Splice of Plain-Laid Rope	613-79
613-2-14.	Short Splice of Plaited Rope (8 Strand)	613-80
613-2-15.	Long Splice of Plain-Laid Rope	613-81
613-2-16.	Preparing Plaited Rope for Long Splice	613-82
613-2-17.	Marrying Plaited Rope Strands for Long Splice	613-83
613-2-18.	Tucking Plaited Rope Strands for Long Splice	613-84
613-2-19.	Completing Plaited Rope Long Splice	613-85
613-2-20.	Extracting Cores from Double Braided Rope, Long Splice	613-86

LIST OF ILLUSTRATIONS - Continued

Figure	Title	Page
613-2-21.	Putting Covers Inside Cores of Double Braided Rope, Long Splice	613-86
613-2-22.	Reinserting Core Into Covers of Double Braided Rope, Long Splice	613-86
613-2-23.	Burying the Exposed Cores of Double Braided Rope, Long Splice	613-87
613-2-24.	Completing the Double Braided Rope, Long Splice	613-87
613-2-25.	Throat Seizing	613-87
613-2-26.	Correct Method of Securing on H-Bitts with Round Turns	613-88
613-2-27.	Overriding Turns on a Capstan	613-88
613-2-28.	Relaxed Synthetic Fiber Rope	613-99
613-2-29.	Synthetic Fiber Rope Maximum Workload	613-99
613-2-30.	Towing Thimble613-102
613-2-31.	Correct Method of Making a Side-Tow Hitch613-104
613-2-32.	Correct Method for Doubling-Up613-104
613-2-33.	Synthetic Rope Showing Fuzzy Nap as a Result of Normal Wear613-105
613-2-34.	Synthetic Rope Containing a Cockle613-106
613-2-35.	Synthetic Rope Showing Cut Condition613-106
613-2-36.	Synthetic Rope Showing Surface Fusion and Chafing613-106
613-2-37.	Rope Showing Rust Damage613-106

CHAPTER 613

WIRE AND FIBER ROPE AND RIGGING

SECTION 1.

WIRE ROPE

613-1.1 FABRICATION

613-1.1.1 GENERAL. Wire rope is a highly specialized precision product which is adaptable to many uses and to varied conditions of operation. To meet the exacting requirements of different types of service, it is designed and manufactured in a number of constructions and grades.

613-1.1.2 COMPLEXITY. Wire rope is a complex machine, composed of a number of precise, moving parts which are designed and manufactured to bear a very definite relationship to one another. In fact, many wire ropes contain more moving parts than most mechanisms that fall within the broad general term of machines. For example a six-strand rope, consisting of approximately 46 wires per strand, contains a total of 276 individual wires, all of which must be able to move with respect to one another if the rope is to have the necessary flexibility during operation.

613-1.2 PARTS

613-1.2.1 GENERAL. Wire rope is composed of three parts: wires, strands, and core. The basic unit is the wire. A predetermined number of wires of proper size are fabricated in a uniform geometric arrangement of definite pitch or lay to form a strand of required diameter. The required number of strands are then laid together symmetrically around a core to form the rope [Figure 613-1-1](#)).

613-1.2.2 CORE TYPE. In general, wire rope cores are of three types: fiber, wire strand, and independent wire rope (IWRC) as illustrated in [Figure 613-1-2](#). Each type of core serves the basic purpose of affording support to the strands laid around it.

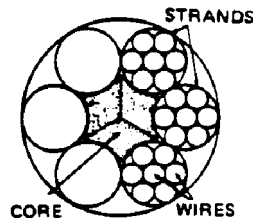

Figure 613-1-1. Wire Rope Construction

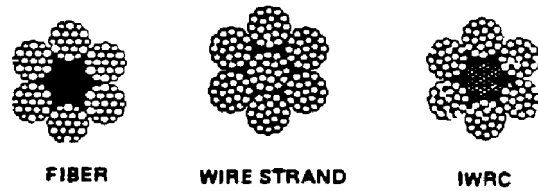

Figure 613-1-2. Core Construction

613-1.2.3 CORE MATERIAL. Fiber core applies to any natural or synthetic fibrous material that is woven into a rope of its own. Fiber cores are generally made of polypropylene or a hard fiber such as manila (abaca) or sisal. Strand cores and independent wire rope cores are composed of wires.

613-1.2.4 CHOICE OF CORE. Fiber cores are adequate for most types of service. Not only do they provide the necessary foundation, but they also add to the pliability of a wire rope. There are some installations, however, where conditions are such that a fiber core is inadequate; in these cases a wire strand or independent wire rope core is used. For service where high operating pressures are encountered, where resistance to heat, additional strength, or minimum stretch is a prerequisite, either a strand core or an independent wire rope core is used.

613-1.3 LAYS

613-1.3.1 GENERAL. The type of lay describes the direction of the twist of the wires in a strand and of the strands in a rope. Strand and rope lays are described in the following paragraphs ([Figure 613-1-3](#)).

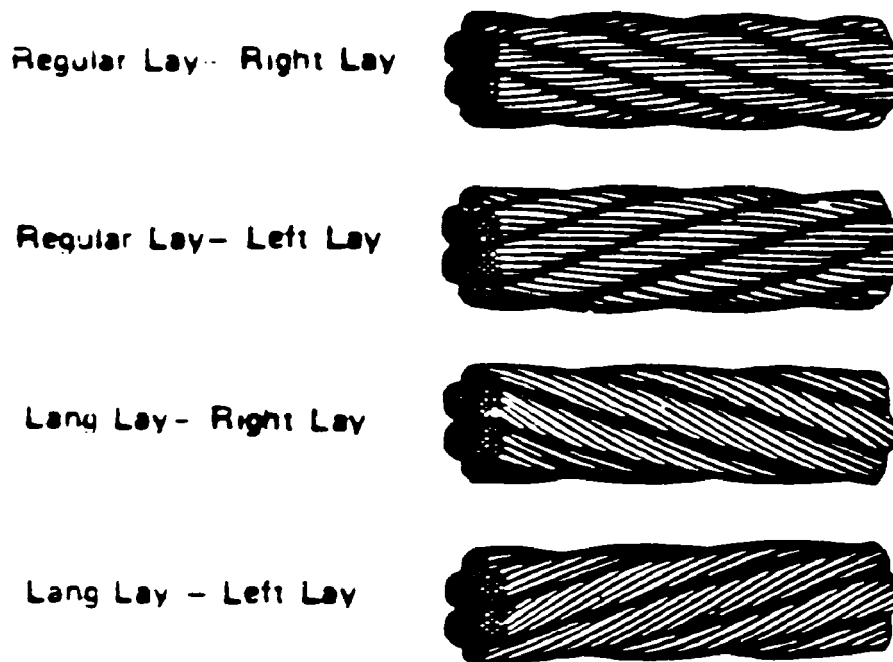

Figure 613-1-3. Wire Rope Lays

613-1.3.2 **RIGHT LAY OR RIGHT-HAND HELIX.** The strands in the wire rope are laid to form a helix about the core similar to the threads in a right-hand screw. When viewed lengthwise, the strands are wound helically away from the observer in a clockwise direction.

613-1.3.3 **LEFT LAY OR LEFT-HAND HELIX.** The strands in the wire rope are laid to form a helix about the core similar to the threads in a left-hand screw. When viewed lengthwise, the strands are wound helically away from the observer in a counterclockwise direction.

613-1.3.4 **REGULAR LAY.** The wires in the strands and the strands in the rope are laid in opposite directions.

613-1.3.5 **LANG LAY.** The wires in the strands and the strands in the rope are laid in the same direction.

613-1.3.6 **PITCH OR LENGTH OF LAY.** The length of a rope lay is that distance measured parallel to the axis or centerline of a rope in which a strand makes one complete spiral or turn around the rope. The length of a strand lay is the distance measured parallel to the axis or centerline of the strand in which one wire makes one complete spiral or turn around the strand. The distance is illustrated in [Figure 613-1-4](#).

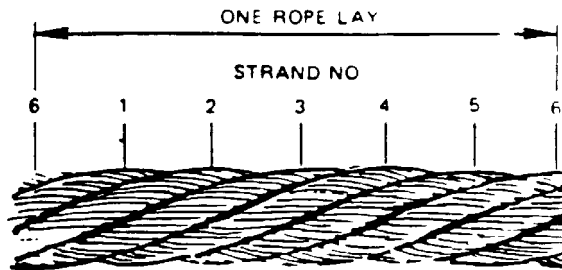

Figure 613-1-4. Length of Rope Lays

613-1.4 SIZE

613-1.4.1 The diameter of a wire rope is the diameter of the circle which will just enclose all of the strands. In the case of strands, the diameter is that of the circle which will just enclose all of the wires. The correct diameter is the greatest diameter of the rope or strand. [Figure 613-1-5](#) shows the correct and incorrect ways of measuring wire rope.

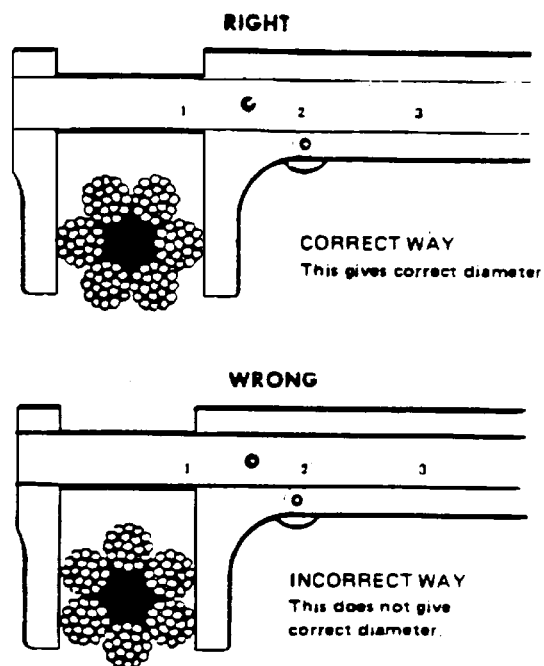

Figure 613-1-5. Measuring Wire Rope

613-1.5 CONSTRUCTION.

613-1.5.1 GENERAL. The design arrangement of the component parts of the wire rope is called the construction. To date, nearly 100 different constructions have been manufactured. Figure 613-1-6 shows some of the more typical wire rope constructions. Construction of wire rope is designated first by the number of strands and then by the number of wires in a strand; therefore a 6 by 7 rope has six strands with seven wires per strand. When wire rope contains wires of different sizes, the construction is usually designated by name as well as by number. Examples of some typical construction types are contained in paragraphs 613-1.5.2 through 613-1.5.6.

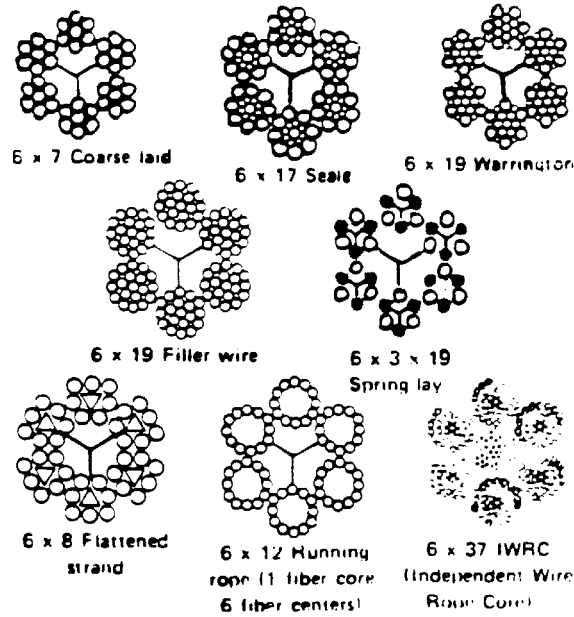

Figure 613-1-6. Common Wire Rope Construction, Examples

613-1.5.2 SEALE CONSTRUCTION. Each strand consists of three rings of wire. The first ring of wires around the center wire of the strand is of smaller diameter than the center and outer wires.

613-1.5.3 WARRINGTON CONSTRUCTION. Each strand has two layers of wire about a center wire. The outer layer consists of wires that are alternately large and small.

613-1.5.4 FILLER WIRE. Filler wire has small wires filling the voids between the rings of wire in the strand. These small wires are not counted when designating the number of wires in the strand.

613-1.5.5 FLATTENED STRAND. Strands are somewhat triangular in shape, sometimes formed around a triangular center wire.

613-1.5.6 SPRING LAY. The spring lay is composed of six main strands laid around a fiber core. Each main strand consists of three preformed wire strands and three fiber strands laid alternately around a fiber center. The function of the fiber parts is to provide a cushion for the wire strands and results in a rope having great flexibility and elasticity.

613-1.6 PREFORMED WIRE ROPE

613-1.6.1 Preformed wire rope is rope whose wires and strands have been preshaped to conform to the curvature which they take in the finished rope. Preforming eliminates the locked up stress and strain existing in non-preformed wire rope, prevents the rope from flying apart when cut or broken, and resists kinking. Preforming helps to eliminate the tendency of a rope to rotate about its own axis. Preformed wire rope is more easily spliced since the strands fit perfectly into place. However, owing to the permanent helical shape of the strands, the technique of tucking the ends differs from that of nonpreformed wire rope. This type of wire rope is designed to give extra life when used for operating ropes, particularly when used over small sheaves and when operating with

S9086-UU-STM-010/CH-613R3

small safety factors. Preforming is of greatest value when normal failures occur through fatigue. Preformed wire rope is of no advantage when used as standing rigging, or in applications where the chief cause of failure is abrasion or corrosion.

613-1.7 ZINC-COATED OR WIRE ROPE

613-1.7.1 In order to protect wire rope against the action of salt water and other corrosive elements, and to prevent rust, wire is galvanized (zinc-coated) or tinned, as the case may require. Wire rope so treated is generally used for standing rigging. It may also be used for running rigging and for wheel (steering) ropes on ships. This type of service does not cause ropes to wear rapidly. Wire rope subjected to constant bending around drums and sheaves, such as in hoisting service, is not usually so treated because the constant flexing of the rope will cause the protective coating to peel.

613-1.8 CONDITIONS OF USE

613-1.8.1 CHARACTERISTICS. Different types and constructions of rope have been developed over the years to meet special conditions of use. Initially, ropes were used for hauling purposes where flexibility was not a requirement. Simple ropes, such as the 6 by 7 and 8 by 7, were constructed of rather large wires. This produced a rope well qualified to resist abrasion, but not particularly well adapted for service where flexibility was essential. In most cases, use a 6 by 7 rope with a relatively high safety factor since its reserve strength is low. When wire ropes started being used for hoisting purposes, it became necessary to increase the number of wires, which for a given diameter of rope means smaller wires and greater flexibility. In general, flexibility increases with the number of wires. The Seale, Warrington, and filler wire types were developed to increase the total metallic area for a given diameter rope. The average increase is about 10 percent, though in the Seale construction this is accomplished at some sacrifice of flexibility. The problem of rope wear when used over sheaves soon becomes apparent. The smaller the diameter of the bearing (outer) wires, the greater the number of those wires which may break during wear. Accordingly, the flattened strand type of construction was developed which, for a given total metallic cross-sectional area, provides a greater bearing surface resulting in more wear distribution.

613-1.8.2 USES. For naval installations, the types and uses of wire ropes may, generally, be grouped as described in paragraphs [613-1.8.2.1](#) through [613-1.8.2.6](#).

613-1.8.2.1 6 by 7. Only the galvanized type is specified. This construction is the stiffest of all the wire rope varieties made available by specifications. It is not suitable for general hoisting, but is mainly applicable for permanent standing guys.

613-1.8.2.2 6 by 12. This construction with a fiber core and a fiber center in each strand is more flexible than either the 6 by 19 or 6 by 37 construction, but it is not as strong. When made of galvanized steel wire, it may be used for guys, ridge ropes, boat ladders, Jacob's ladders, boom pendants, and running rigging. It is desired for running rigging service where extreme flexibility is required and exposure to moisture is frequent. It may also be used for wire mooring lines. When made of phosphor bronze wire, it may be used for life lines, wheel ropes, or rigging, where either noncorrosive or nonmagnetic properties are required.

613-1.8.2.3 6 by 19. When made of ungalvanized steel wire, this rope is principally used where great strength is required, particularly on derricks and dredges. It is the stiffest and strongest construction of the types of wire ropes suitable for general hoisting purposes. To obtain the best results, sheaves for this type of rope should be larger than those for the other more flexible types. When made of galvanized steel wire, the 6 by 19 wire rope

may be used for standing rigging, guys, boat slings, topping lift pendants for booms, running rigging (7/16 inch and under), and wheel rope (7/16 inch and under). When made of phosphor bronze wire, this rope may be used for life lines, clearing lines, wheel ropes, rigging, radio antennas, and antenna downleads, where either noncorrosive or nonmagnetic properties are desired.

613-1.8.2.4 6 by 24. This construction with a fiber core and a fiber center in each strand has almost the same flexibility as the 6 by 12 construction, but it is stronger. It is used primarily in the larger sizes, where the strength of a 6 by 12 rope of the same size is not satisfactory, and where extreme flexibility is the major consideration.

613-1.8.2.5 6 by 37. When made of ungalvanized steel wire, this construction is very flexible, making it suitable for cranes and similar machinery where sheaves are of necessity smaller than desirable. It may be used for heavy hoisting, especially where bending conditions are unusually severe. Hoisting ropes larger than 1/2 inch in diameter are usually of this type. Its wires are smaller than in the 6 by 19 wire rope, and consequently will not stand as much abrasive wear. It has good reserve strength however, because a little over 50 percent of the wires, and consequently over 50 percent of the strength, are in the inner layers of the strand protected from abrasion. When made of galvanized steel wire, the 6 by 37 wire rope may be used for steering gear, transmission rope, hawsers (where great strength is required), relieving tackle, towing hawsers, bridles (large and small), tiller ropes, torpedo slings, clear hawse pendants, and slings for general hoisting.

CAUTION

Since the stretch properties of spring lay rope are different from fiber or wire rope, do not mix spring lay with these ropes.

613-1.8.2.6 6 by 3 by 19, Spring Lay Rope. This construction with a fiber core and a fiber center in each strand has almost the same flexibility as the 6 by 12 construction, but it is stronger. It is used primarily in the larger sizes, where the strength of a 6 by 12 rope of the same size is not satisfactory, and where extreme flexibility is the major consideration.

NOTE

To determine the safe service life of spring lay, the inspection and replacement criteria for wire rope (paragraphs [613-1.10.2](#) and [613-1.10.3](#)) shall apply.

613-1.8.3 STRENGTH. In addition to being suitable for a particular service, the type, class, and construction of a wire rope shall be strong enough to stand the stresses put upon it without permanent deformation constituting a hazard to life or property or requiring frequent renewal. The strength of a wire rope of a given construction depends upon its size (diameter) and the material from which it is made. For any particular size and material, the breaking strength may be obtained from tables given in FED Spec RR-W-410 or in the **Catalog of Navy Material, General Stores Section, FSC Group 4010**. The breaking strengths of 6 by 19 and 6 by 37 wire rope are shown in [Table 613-1-1](#). A wire rope installation shall be designed with a suitable design factor between the total load and breaking strength of a new rope. As rope gets older, wear and corrosion reduce its strength. The strength of an old rope is appreciably less than that of the new one. Because the destruction of life and property due to failure of a rope is usually so much greater than the value of the rope, it is a good policy to use a rope several times stronger than calculated total stress to ensure against premature failure.

S9086-UU-STM-010/CH-613R3

613-1.8.4 FACTOR OF SAFETY. The ratio between the breaking strength of a rope and the total applied load is the safety factor. Experience has shown that a wire rope will last longer if the load to which it is subjected in service never approaches its breaking strength. In other words, a rope which costs more per foot may cost less per annum because of the greater service obtained from it. For ordinary hoisting ropes on shipboard, a minimum safety factor of five is normally used. The safety factor usually is increased for ropes running continuously at high speed over sheaves, where safety of life is involved, or where deterioration may be expected because of causes such as unusual abrasion or poor lubrication. Always replace wire rope with the one specified for the particular application. Consult the equipment technical manual, drawing, COSAL, Ship's Information Book, or the wire rope list.

613-1.8.5 FITTINGS. End fittings and associated hardware shall conform to the following specifications:

- a. Sockets: RR-S-550
- b. Fiege-Type: MIL-S-21433
- c. Swage Sleeves: Commercial supplied by the same manufacturer of the swaging machine
- d. Thimbles: FF-T-276 Type III only
- e. Shackles: RR-C-271
- f. Blocks: MIL-B-24141.

Table 613-1-1. WIRE ROPE ACCEPTANCE BREAKING STRENGTH

ACCEPTANCE BREAKING STRENGTH (LBS)						
RR-W-410, Type I, General Purpose						
Class 2, 6 by 19 and Class 3, 6 by 37						
Single Operation Strand						
Diameter (in)	Improved Plow Steel				Extra Improved Plow Steel	
	Fiber Core		IWRC		IWRC	
	Uncoated	Galvanized	Uncoated	Galvanized	Uncoated	Galvanized
1/4	5,340	4,820	5,740	5,160	6,640	5,960
5/16	8,300	7,460	8,940	8,040	10,280	9,240
3/8	11,900	10,700	12,800	11,500	14,720	13,260
7/16	16,120	14,500	17,340	15,600	19,900	17,900
1/2	20,800	18,780	22,400	20,200	26,000	23,400
9/16	26,400	23,800	28,200	25,400	32,800	29,400
5/8	32,600	29,200	35,000	31,400	40,200	36,000
3/4	46,400	41,800	50,000	44,800	57,400	51,600
7/8	62,800	56,600	67,400	60,600	77,600	69,800
1	81,600	73,400	87,600	78,800	100,800	90,600
1-1/8	102,600	92,200	110,200	99,200	126,800	114,000
1-1/4	126,000	113,200	135,400	121,800	155,800	140,200
1-3/8	151,600	136,400	162,800	146,600	187,200	168,400
1-1/2	179,400	161,000	192,800	173,600	222,000	200,000
1-5/8	208,000	187,800	224,000	202,000	258,000	232,000
1-3/4	242,000	218,000	260,000	234,000	298,000	268,200
1-7/8	274,000	248,000	296,000	268,000	340,000	306,000
2	312,000	280,000	336,000	302,000	386,000	347,000
2-1/8	350,000	314,000	374,000	338,000	431,000	388,000
2-1/4	390,000	351,000	420,000	378,000	482,000	434,000
2-1/2	476,000	429,000	511,000	460,000	589,000	530,000
2-3/4	570,000	512,000	612,000	552,000	704,000	634,000
3	668,000	601,000	722,000	650,000	828,000	745,000
3-1/4	778,000	700,000	830,000	752,000	960,000	864,000
3-1/2	892,000	802,000	958,000	862,000	1,100,000	990,000

S9086-UU-STM-010/CH-613R3

613-1.8.5.1 Test. Each shackle, end fitting, or block shall be tested in accordance with the applicable specification and certified by the manufacturer to the procuring activity.

613-1.8.5.2 Marking. Each shackle, end fitting, or block shall be permanently and legibly marked in raised or stamped letters with the identifying manufacturer's name or trademark, size (and safe working load on shackles and blocks). Thimbles are not required to be marked.

613-1.8.5.3 System Applicability. Paragraph 613-1.8.5 applies only to those weight-handling systems where the fittings are required or were procured to the specifications listed (as identified in technical manuals, drawings, etc), or where no other guidance exists. Paragraph 613-1.8.5 is not intended to apply to those systems which use special wire rope fittings (e.g., boat davit wire rope sockets, boat gripe fittings, elevator swaged fittings). For UNREP equipment see NAVSEA S9570-AD-CAT-01B, **Underway Replenishment Hardware and Equipment Manual** . For weapons handling equipment see **NSTM Chapter 700, Shipboard Ammunition Handling and Stowage** . Naval shore installations under the technical cognizance of Naval Facilities Engineering Command (NAVFACENGCOM) are governed by NAVFAC P-307, **Management of Weight-Handling Equipment, Maintenance and Certification** . Contact the Life-Cycle Engineering Manager (LCEM) or In-Service Engineering Agent (ISEA) to determine applicability to specific systems or to obtain specific technical guidance.

613-1.9 CARE AND PRESERVATION

613-1.9.1 STORAGE. When a shipment of wire rope is not to be placed in service immediately, store it in a place protected from the weather and from possible contact with acid or acid fumes. The importance of keeping acid or acid fumes away from wire rope cannot be over-emphasized. Do not store wire rope in places where acid is or was kept. The slightest trace of acid is apt to damage wire rope at the point of contact. Many times, rope which has given away at one point, has been found to be acid damaged. To afford protection from acid or other corrosive elements, coat the outside layer of wire rope on a reel or coil with a lubricant.

613-1.9.2 UNCOILING AND UNREELING. Exercise great care when removing wire rope from a coil or reel. During this stage of installation, serious and permanent damage due to kinking very often is done to wire rope. However, if the simple precautions set forth below are followed, proper balance between strands will be maintained in the rope.

1. If wire rope is received in a coil, lay the free end on the floor, stand the coil on edge, and unroll it as illustrated in [Figure 613-1-7 \(A\)](#). An alternate method is to place the coil on a revolving shaft and pull it off as shown in [Figure 613-1-7 \(B\)](#). Under no circumstances lay a coil on its side and pull the rope.
2. The same type of handling applies to unreeling. Either support the reel on a pipe or bar through the center hole and pull the rope, leaving the reel free to revolve as illustrated in [Figure 613-1-8 \(A\)](#), or place the reel flat on its side on a revolving shaft and pull the rope off as shown in [Figure 613-1-8 \(B\)](#). With the former method, a timber brake placed against the flange of the reel to provide back tension will ensure snug and uniform unwinding. Under no circumstances lay the reel upon its side and pull the rope over the reel flange.

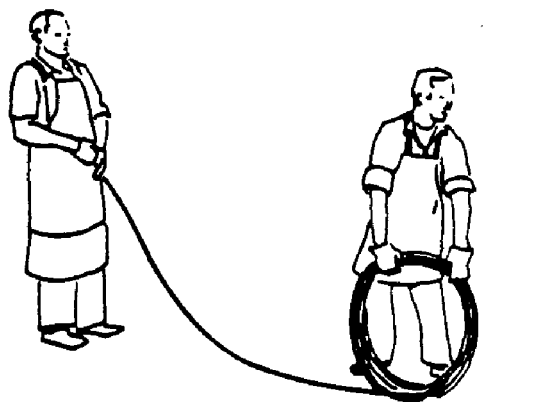

A

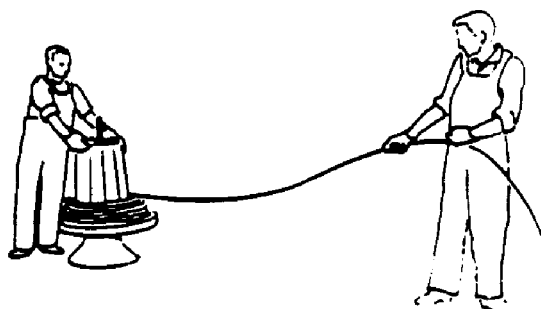

B

Figure 613-1-7. Uncoiling Wire Rope

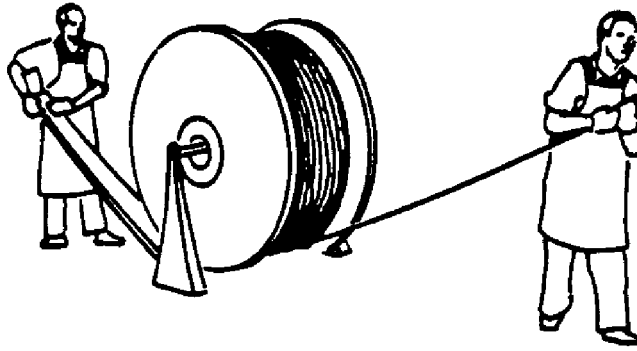

A

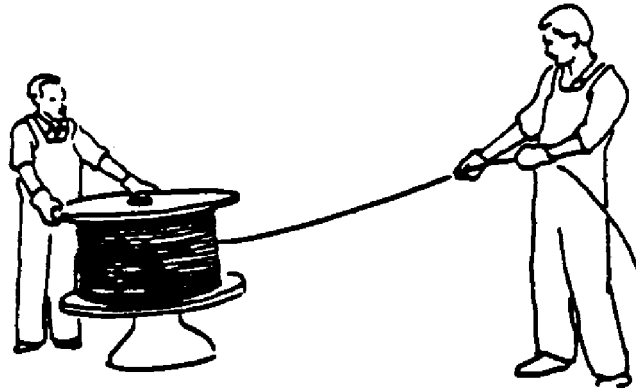

B

Figure 613-1-8. Unreeing Wire Rope

613-1.9.3 KINKING AND RESULTING ROPE DAMAGE. One of the most common forms of damage resulting from improperly handled wire rope is the development of a kink. A kink starts with the formation of a loop, as illustrated in Figure [613-1-9](#) and Figure [613-1-10](#).

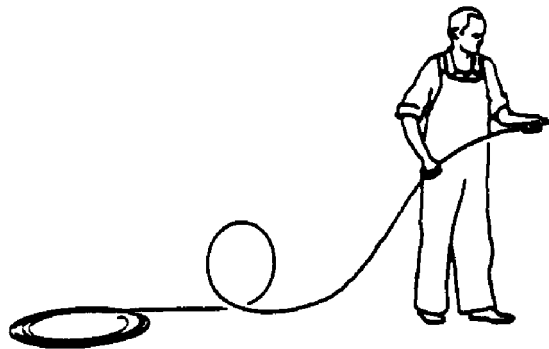

Figure 613-1-9. Improper Handling

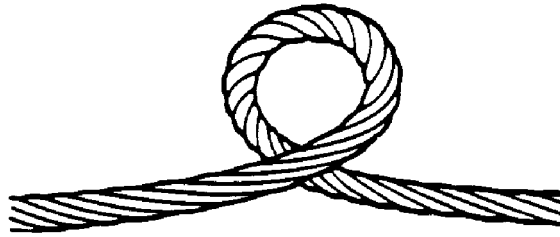

Figure 613-1-10. Wire Rope Loop

- a. If any of the improper practices in uncoiling and unreeling are used, a spiral condition is produced in the rope which is very difficult to remove. Usually this condition leads to kinking which is almost certain to result in the complete destruction of the wire rope. It is important to note that once a kink has been tightened in a rope, permanent and irreparable damage is done. A loop may also be formed if an attempt is made to either lengthen or shorten the rope lay from its natural position when, at the same time, sufficient slack is present in the rope. A loop and a resultant kink may be formed in a rope in service, but conditions of operation are such that potential damage of this type is not a significant factor. It is more common to encounter kink damage during the handling of a rope before its operation. Kinking can be best prevented by proper uncoiling and unreeling methods and by the correct handling of the rope throughout its installation.
- b. A loop that has not been pulled tight enough to set the wires or strands of the rope permanently can be removed by turning the rope at either end in the proper direction to restore the lay. If this is not done, or if the loop is pulled tight enough to set the wires, the spot in question will be damaged irreparably, and that section should not be used.
- c. If the loop is pulled tight, as shown in Figure 613-1-11, a very severe distortion of the rope and the strands (a kink) will result. Figure 613-1-12 shows the kinked section after it has been pulled and straightened under load. The set in the rope still remains and the strands are distorted so that the wires are not in their proper relative positions.



Figure 613-1-11. Wire Rope Kink



Figure 613-1-12. Kink Damage

613-1.9.4 DRUM WINDING. Spooling wire rope on a winch drum results in a slight rotating tendency of the rope due to the spiral lay of the strands. There are two types of winch drums used for spooling wire rope:

- a. Grooved drum. When grooved drums are used, the grooves generally give sufficient control to wind rope properly, whether it is right or left lay rope.

S9086-UU-STM-010/CH-613R3

- b. Smooth-faced Drum. When smooth-faced drums are used, where the only other influence on the rope in winding on the first layer is the fleet angle, the slight rotational tendency of the rope may be used to an advantage in keeping the windings close and uniform.

NOTE

Fleet angle is the angle at which the rope approaches the sheave from the drum.

- c. Rotation of wire. Standing behind the winch drum and looking toward an oncoming overwind rope, the rotating tendency of a right lay rope is toward the left, whereas, the rotating tendency of a left lay rope is toward the right.
- d. Attachment Point. With a smooth-faced drum, overwind reeving, and a right lay rope installation, make the wire rope bitter end attachment point to the drum flange at the left flange as shown in Figure 613-1-13. With underwind reeving and a right lay rope installation, make the wire rope bitter end attachment point at the right flange as shown in Figure 613-1-14.

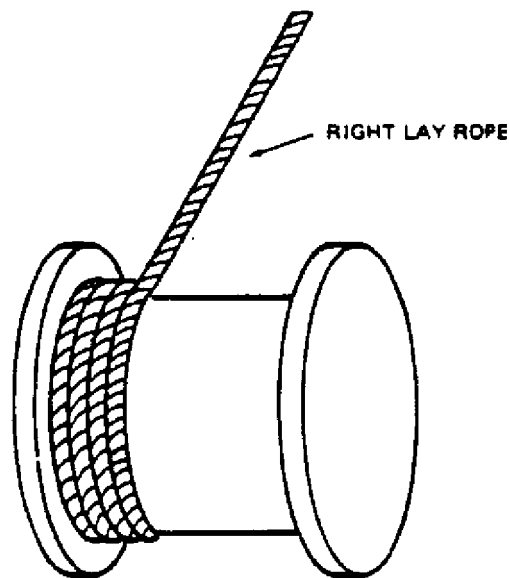

Figure 613-1-13. Overwind Reeving Attachment Point

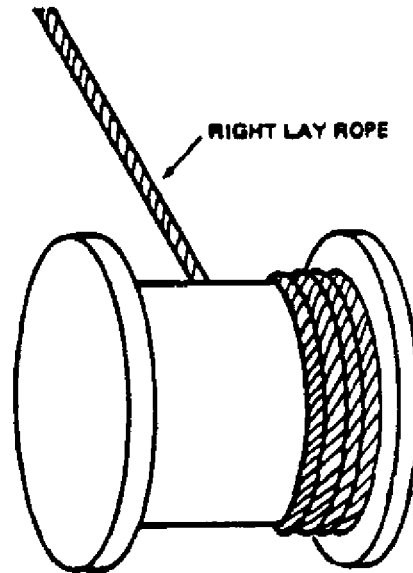

Figure 613-1-14. Underwind Reeving Attachment Point

- e. Standard Installation. Standard wire rope installations use right lay rope. Only in special cases is left lay rope used. One example would be when an opposite rotating tendency might help prevent open winding, or piling up at the flange under adverse fleet angle conditions. When left lay rope is used, whether overwind reeving or underwind reeving installation, the bitter end attachment point on the drum flange is opposite to right lay rope.

613-1.10 INSPECTION, REPLACEMENT, AND LUBRICATION

613-1.10.1 GENERAL. Where the Planned Maintenance System (PMS) is installed, conduct preventive maintenance in accordance with Maintenance Requirement Cards (MRC).

613-1.10.2 INSPECTION. Unless experience with specific operating conditions indicates that more frequent inspections are required, visually inspect all running rope in service quarterly to determine whether deterioration has resulted in appreciable loss of original strength and constitutes a safety hazard. For standing rigging systems, refer to Section 3; Rigging.

613-1.10.2.1 External Inspection. The external inspection criteria for general usage running rope is as follows:

- a. Reduction of nominal rope diameter due to loss of core support or internal or external corrosion or wear of individual outside wires. The diameter shall be measured in a circumscribing circle in six or more places on the rope. For the correct method of measuring diameter see Figure 613-1-5.
- b. Number of broken outside wires and degree of distribution or concentration of broken wires
- c. Corroded, pitted, or broken wires at end connections
- d. Corroded, cracked, bent, worn, or improperly applied end connections
- e. Severe kinking, crushing, or distortion of rope structure
- f. Evidence of heat damage from any cause.

613-1.10.2.2 Internal Inspection. A wire rope can be opened for internal inspection only when completely relaxed. Using care to avoid damaging the strands or core, open the wire rope in six or more places, by working a marlin spike beneath two strands. Carefully rotate the spike to expose the core and underside of the strands. Inspect for evidence of internal corrosion, broken wires, or core failure. Particular attention shall be given to the wire rope in areas close to end fittings, those lengths that pass over sheaves, onto drums, or that remain exposed to or immersed in seawater. If a wire rope has been opened properly and carefully, and internal condition does not show cause for removal, the strands can be returned to their original working positions without distorting the wire rope or impairing future usefulness. Only qualified personnel shall be authorized to inspect wire rope.

NOTE

Local commands shall determine which personnel are qualified to open the lay of the rope without nicking the individual wires or disturbing the lay of the strands.

613-1.10.3 GENERAL. Where the Planned Maintenance System (PMS) is installed, conduct preventive maintenance in accordance with Maintenance Requirement Cards (MRC).

- a. The nominal rope diameter is reduced by more than the amount shown in Table 613-1-2 for the applicable size rope, or there is an unexpected increase in lay length as compared to previous lay length measurements. Retain previous measurements for comparison purposes. See Figure 613-1-4 and Figure 613-1-5 for the correct method of measuring lay length and diameter.
- b. Six broken wires in one rope lay length, or three broken wires in one strand lay length. See for definition of lay length.

Table 613-1-2. WIRE ROPE ALLOWABLE DIAMETER REDUCTION

Rope Diameter (Inches)	Maximum Allowable Nominal Diameter Reduction (Inches)
5/16 and smaller	1/64
3/8 to 1/2	1/32
9/16 to 3/4	3/64
7/8 to 1-1/8	1/16
1-1/4 to 1-1/2	3/32
1-9/16 to 2	1/8
2-1/8 to 2-1/2	5/32

- c. One broken wire within one rope lay length of any end fitting.
- d. Wear of 1/3 the original diameter of outside individual wires, evidenced by flat spots almost the full width of the individual wire, extending one lay length or more.
- e. Pitting due to corrosion, or nicks, extending one lay length or more.
- f. Pitting due to corrosion, or nicks, extending one lay length or more.
- g. Severe kinking, crushing, or any other damage resulting in distortion of the rope structure.
- h. Evidence of internal corrosion; broken wires on the underside of strands or in the core.

613-1.10.4 LUBRICATION. Wire ropes are lubricated during fabrication. The amount and grade of lubricant used depends on the size and type of rope. The lubricant is compounded with additives to provide lubricating

qualities and corrosion protection during shipping, storage, handling, initial period of service, and a suitable base for subsequent field lubrication. Before placing wire rope into service and periodically as specified for a particular application, apply MIL-Spec lubricant (MIL-G-18458), working the lubricant into the valleys and between the strands using sufficient lubricant to coat the outer wires. Use a wire rope lubricator (AEL 2-920014777), when available, or grease by hand. Thoroughly lubricate the wire rope at the base of end fittings. Remove excessive grease from the wire rope.

1. Wire rope coated with preservative, such as Cosmoline, shall be cleaned and lubricated before being placed into service.
2. Periodic lubrication is required because wire rope is really a mechanical device with many moving parts. Each time a rope bends or straightens, the wires in the strands and the strands in the rope slide upon each other. A film of lubricant is needed on each moving part. Another important reason for lubricating iron and steel wire ropes is to prevent corrosion of the wires and deterioration of the hemp, synthetic, or steel core. There is no known method to determine the strength of a corroded rope. A rusty rope is a liability.

WARNING

When cleaning wire rope with JP-5, it is mandatory that safety goggles, gloves, and protective clothing be worn. Use a well ventilated area, preferably open air, to reduce the possibility of fume inhalation. See NSTM Chapter 670, Stowage, Handling, and Disposal of Hazardous General Use Consumables .

3. Clean used ropes before they are lubricated. Accomplish cleaning by means of wire brushes, compressed air, superheated steam, JP-5, or turbine oil MIL-L-17331 (2190). The object is to remove all foreign material and old lubricant from the valleys between the strands and from the spaces between the outer wires.

CAUTION

Under no circumstances is wire rope to be soaked in JP-5 because it may cause the inner lubricants to be removed from the wire rope and core. Wire rope may be soaked in turbine oil if soaking is desired.

4. When a wire rope is to be taken out of service for an appreciable length of time, clean and lubricate it before storage. Refer to paragraph [613-1.9.1](#) for storage requirements.

613-1.11 SPLICING AND TERMINATING

613-1.11.1 SEIZING. Seizing is defined as the process of securing one rope to another, two or more parts of the same rope to itself, or fittings of any kind to a rope (or other object) by binding with annealed iron wire. In the manufacture of wire rope, great care is exercised to lay each wire in the strand and each strand in the rope under uniform tension. If the ends of the rope are not secured properly, the original balance of tension will be disturbed and maximum service will not be obtained, because some strands will carry a greater portion of the load than others.

1. Before cutting wire rope it is necessary to apply proper seizing on both sides of the place where the cut is to

be made to prevent disturbing the uniformity of the rope. For preformed ropes, one seizing on each side of the cut is normally sufficient. For ropes that are not preformed, a minimum of two seizings on each side is required, and these are to be spaced six rope diameters apart. Always apply seizing in the opposite direction from the lay of the rope to prevent loosening when the rope shrinks as a result of loading.

NOTE

Each seizing shall consist of closely wound wraps of seizing wire. The length of the seizings should never be less than the diameter of the rope being seized.

- It is important to use the proper size and grade of wire for seizing. The proper sizes of seizing wire for use with a range of wire rope diameters are listed in [Table 613-1-3](#).

Table 613-1-3. SEIZINGS FOR WIRE ROPE

Rope Diameter (Inches)	Annealed Iron Seizing Wire Diameter (inches)
1/2 and smaller	0.035
9/16 to 7/8	0.063
1 to 1-1/2	0.092
1-5/8 to 2-1/8	0.120
2-1/4 and larger	0.135

613-1.11.1.1 Temporary Seizing. The procedure for making a temporary seizing is illustrated in [Figure 613-1-15](#) using the following methods:

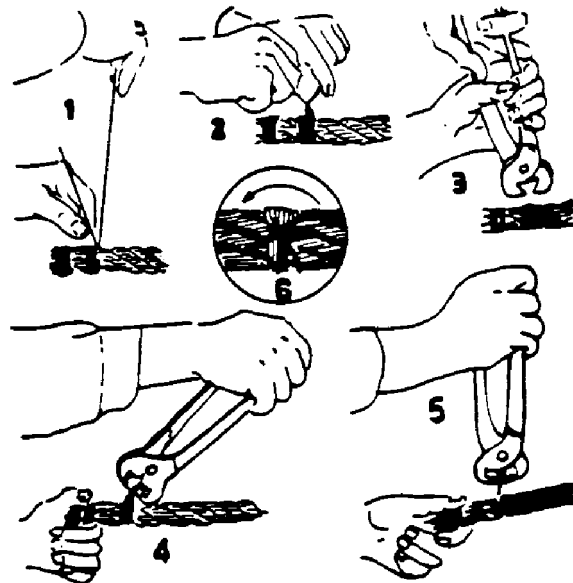

Figure 613-1-15. Seizing

- Uniformly wind on the annealed, iron seizing wire using good tension on the wire.
- Twist wire ends counterclockwise.

3. Grasp ends with end cutting nippers (detachable cutter type) and twist up slack. Do not try to tighten up on seizing by twisting.
4. Draw up on seizing to remove slack.
5. Twist up slack created in step 4.
6. Repeat steps 4 and 5 until all slack has been removed from the seizing, then cut the excess twists leaving three or four twists. Pound the seizing down on the wire rope with a mallet.

613-1.11.1.2 Permanent Seizing. For ropes where permanent seizing is required and for all ropes 1-5/8 inches in diameter and larger, apply seizing by using a seizing iron as shown in [Figure 613-1-16](#). When applying the seizing, lay one end of the seizing wire in the valley between two strands for a distance of one rope lay, then begin winding the wire, from a starting point at the left, back over the wire in the valley. Apply the first three wraps by hand and the remaining one with the iron, as illustrated in [Figure 613-1-16](#). The desired tension can be applied to the seizing wire by adjusting the nut on the end of the spool shaft or by winding the wire around the seizing iron. Twist together the ends of the seizing, wire, clip short, and depress into the valley between two strands, as shown in [Figure 613-1-17](#).

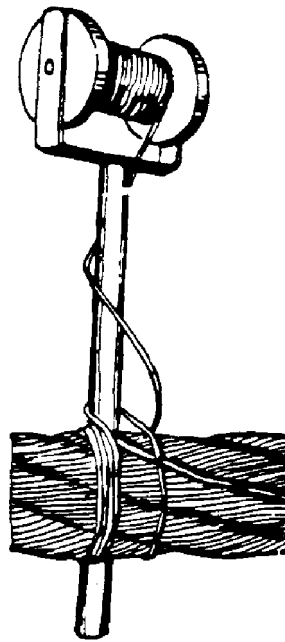

Figure 613-1-16. Seizing Iron

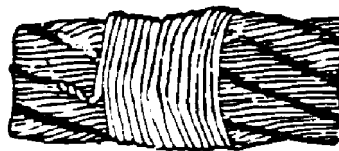

Figure 613-1-17. Permanent Seizing

S9086-UU-STM-010/CH-613R3

613-1.11.1.3 Electrical Sealing. Sealing the bitter ends of wire rope by means of an electric current is approved as an alternate method to manual seizing. Sealing can be accomplished on all sizes of wire rope from 3/16 to 1-1/8 inches in diameter.

613-1.11.2 POURED ZINC SOCKET. Sealing the bitter ends of wire rope by means of an electric current is approved as an alternate method to manual seizing. Sealing can be accomplished on all sizes of wire rope from 3/16 to 1-1/8 inches in diameter.

- a. Boat lifting slings
- b. High speed target towing
- c. LVT lifting slings and tow cables
- d. Ships salvage lifting gear
- e. Minesweeping towing assemblies
- f. Towing wire
- g. Running rigging and standing rigging.

613-1.11.2.1 Need for Qualified Preinstallation Process Control. Need for Qualified Preinstallation Process Control. The strength and durability of a wire rope poured socket in service depends on careful control of the process of installation described in the following paragraphs. Assign only personnel who have been qualified in accordance with paragraph 613-1.11.2.2. Ships and activities that do not have qualified personnel or adequate temperature control and monitoring equipment shall not attempt to pour wire rope sockets.

613-1.11.2.2 Qualification Requirement.

- a. Initial qualification requires assembly of a rope sling with poured zinc sockets at both ends, 1/2 inch diameter x 72 inches long, using uncoated 6 x 37 EIPS, IWRC rope. The assembly will then be subjected to a pull test to destruction. Failure shall occur in the wire rope at or above FED Spec RR-W-410 acceptance breaking strength (26,000 lbs).

NOTE

STREAM highline assemblies are to be obtained through the supply system (NSN 4010-01-309-7439). Repair activities are not authorized to install poured zinc end fittings on STREAM wire highlines.

- b. Requalification of personnel shall be required upon reporting to a new ship or activity or every three years, whichever occurs first, as long as an individual, once qualified, continues to install sockets. Two people may be qualified (or requalified) on the same destruct test, provided that both were involved hands-on in the installation. Local qualification records shall be maintained at the installation activity.
- c. Installation, testing, training and qualification records are the responsibility of the installing activity. Information recorded should include (at minimum) the following:
 - 1 Personnel Records - Date qualified, subsequent requalifications, outside training. Activities should keep these records in Personnel Files.

- 2 Installation Records - Rope size, description, date assembled, date tested, copy of 40 Percent Pull Test Certificate, and description of intended use. Activities shall provide documents to end users and maintain copies of these documents for five years.
- 3 MSDS - Activities shall keep copies of MSD sheets for all materials used in the installation process.

613-1.11.2.3 Steel Wire Rope with Steel Socket. Steel Wire Rope with Steel Socket. The following equipment and procedures are recommended as ones that will produce a 100 percent efficient socket connection:

1. Material and Equipment.

- a Brooming Tool
- b Bucket for Acid or Flux (plastic of acid-compatible material)
- c Electric Hot Plate (for flux solution)
- d Face Shield
- e File
- f Fire Clay
- g Flame Retardant duct sealer or Fire Clay
- h Gas Fired Torch, Hoses and Gauges
- i Glass Cloth
- j Gloves, Rubber and Leather
- k Hydrochloric Acid or Flux (NSN 3439-00-469-3398; Fed Spec O-F-499 Type B; or equal)
- l Ladles
- m Manual Cutter or Power Cut-Off Saw
- n Melting Pot
- o Plastic Buckets, 12 qt. (for hyd. acid, cleaner, rinse, lube oil)
- p Protective Clothing (Heat and Chemical Resistant)
- q Pyrometer
- r Rags
- s Respirator, Metal Fume
- t Seizing Wire ([Table 613-1-3](#)) or Hose Clamps
- u Serving Tool
- v Solvent (NSN 7930-01-328-2030; CITRI-SOLV; NATRA-SOL; Vortex; PF-145 or equal. Contact Carderock Division, Naval Surface Warfare Center (CDNSWC) 9712 if you need assistance locating sources.)
- w Stainless Steel Bucket, 12 qt. (for flux solution)
- x Tape
- y Tempilstick-300F, 400F, and 500F
- z Vise
- aa Washing Soda or Sodium Bicarbonate
- ab Zinc - ANSI/ASTM B6 High Grade
- ac Zinc Kettle with heater capable of 1000°F or Oxyacet. Torch with attachment

2. Seize wire rope securely in two places about one rope diameter apart before cutting the rope. Cut the rope

between the seizings. Measure a length equal to the socket basket from the cut end of the rope and seize at this point and below with three or more seizings. Inspect to ensure seizings are tight to prevent wire rope strands from unlaying at the base of the socket.

NOTE

Hose clamps may be used as an alternative to seizing wire. Ensure that clamps are clean, and that care is taken to not allow wire rope to unlay.

- Line vise jaws with wood or soft metal and secure rope vertically just below the second seizing. Remove the seizing at the cut end of the rope. Unlay the rope strands to the first seizing, [Figure 613-1-18 \(1\)](#), and cut out the fiber core as close to the seizing as possible. If the rope has independent wire rope core (IWRC), do not cut; open up core and broom out wires. Broom out all wires by untwisting them and straightening them as shown in [Figure 613-1-18 \(2\)](#).

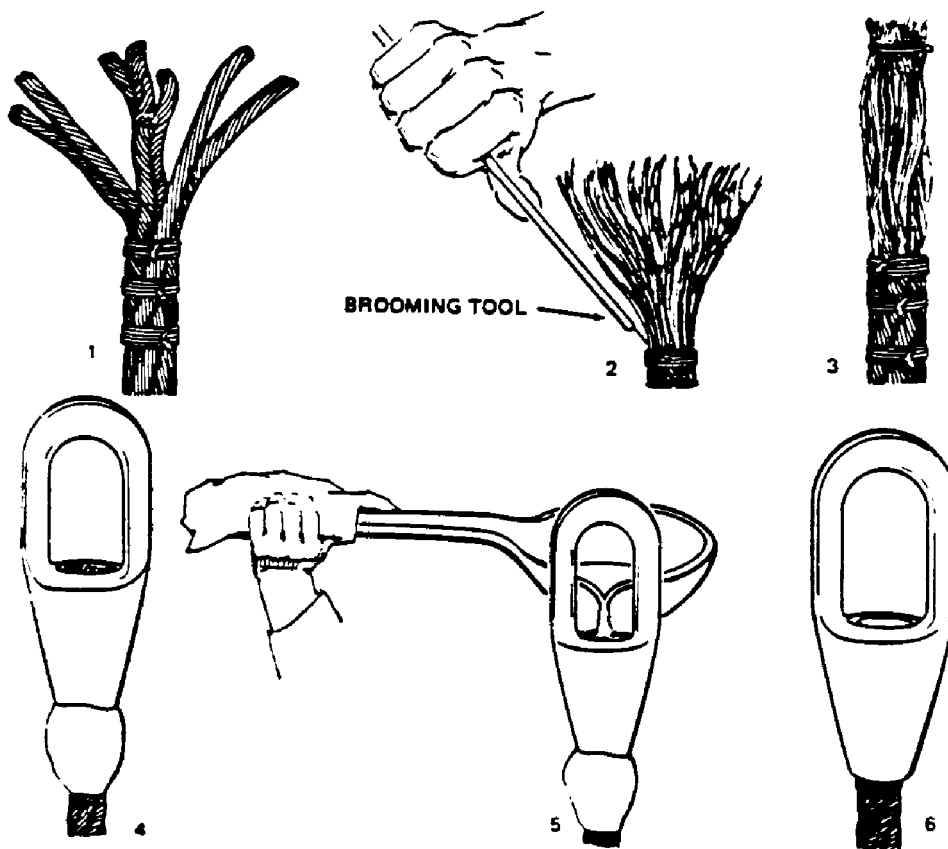

Figure 613-1-18. Socket Pouring

- Repeat step 3 on each individual wire, until the wire rope is completely broomed out. Brooming the ends facilitates maximum penetration and adhesion of the molten zinc filler material. Inspect to ensure each individual wire is untwisted and straight.

WARNING

When cleaning wire rope, it is mandatory that eye protection, gloves, and protective clothing be worn. Use a well ventilated area, preferably open air, to reduce the possibility of fume inhalation. See NSTM Chapter 670 .

5. Cleaning.

- a **Galvanized Wire.** Remove rope from vise and clean all broomed out wires with solvent as near as possible to the first seizing. Swish around until all lubricant and foreign matter is removed from broomed out wires. If cleanliness is questionable, repeat with cleaning solution. Dry with clean compressed air blast. Solvents are available under NSN 7930-01-328-2030 or from commercial sources (e.g., CITRI-SOLV, NATRA-SOL, PF-145, Vortex, or equal).

WARNING

Do not etch galvanized wire with acid.

WARNING

Always add acid to water, never water to acid.

- b **Uncoated Wire; Acid Preparation.** Clean using procedure contained in step 5a. (Treat CRES wire the same as uncoated.) Prepare muriatic acid solution. (Except on CRES wire, which must be etched with acid, flux may be used as an alternative to acid. Dipping in washing soda or sodium bicarbonate solution is not required if flux is used.) Use a plastic bucket and mix an equal amount of hydrochloric (muriatic) acid and water. Dip broomed out wires for three quarters of distance to the first seizing into the acid solution. Take extreme care that acid does not touch any other part of the wire rope. Immersing broomed out wires deeper may draw the acid up into the rope, weakening it. Keep broomed out wires in acid solution long enough to ensure thorough cleanliness. When removing broomed out wires from the acid bath, ensure that wires are held with broomed out end down and lower than the rest of the wire rope, so that acid cannot run into the wire rope. Immediately after removal of the broomed out wires from the acid solution, dip the wires into boiling washing soda or sodium bicarbonate solution to neutralize the acid. Be sure to dip the rope into the soda solution past the point that it was dipped into the acid. Follow this by rinsing wires thoroughly in clean hot water. Dry with clean compressed air blast. Do not touch broomed out wires with hands, rags, gloves, or any object that will impair cleanliness required for an efficient socket connection. Inspect to ensure all wires are clean and free of foreign matter.
- c **Uncoated Wire; Flux Preparation.** If circumstances prevent the use of hydrochloric acid for etching the broomed wires, a zinc chloride/ammonium chloride flux solution can be used. This procedure is not to be used with CRES or Galvanized wire rope. Clean using procedure contained in step 5a. Pour approximately 10 quarts of flux solution into a 12 quart stainless steel container. Heat the container so that the solution reaches a temperature between 160°F to 210°F on an electric hotplate. Immerse broomed wires for three quarters of distance to the first seizing into the flux solution. Hold the broom in this position for three minutes. Do not flux the socket used for the termination. Remove the broomed wires from the solution. Shake off excess solution, and allow the broom to air dry for approximately 5 minutes. When removing the broomed rope from the flux solution, hold the broomed end pointing down toward the bucket, keeping it

lower than the rest of the wire rope. This prevents the solution from flowing into the unlaid portion of the wire rope. Evidence of rust on the surface of broomed wires after the flux drying period will necessitate refluxing of the entire broom. Disregard any red or brown ring at the highest point on the broom which was in contact with the flux. Do not touch broomed out wires with hands, rags, gloves, or any object that will impair cleanliness required for an efficient socket connection. Inspect to ensure all wires are clean and free of foreign matter.

6. Reclamp wire rope in jaws of vise using wood, copper, or aluminum covering on jaws. Be careful not to touch clean broomed out wires.
7. Clean a length of seizing wire long enough to seize the end of broomed out wires and clean a socket using procedure contained in step 5. (If hose clamps are used as an alternative to seizing wire, appropriate modifications to this procedure are permitted; however, care must be taken to keep clean the surfaces that will come into contact with the zinc, to maintain a tight rope lay, and to ensure wires are properly broomed.)
8. Temporarily seize end of broomed out wires so that the socket can be slipped over wires, [Figure 613-1-18](#) (3).
9. Slip socket over seized, broomed out wires and remove end seizing. Ensure wires are distributed evenly around socket basket and flush with top. Ensure socket is in line with axis of rope and rope is in a vertical position, not tilted, [Figure 613-1-18](#) (4). Seal the base of the socket with fire clay, taking care not to push the material into the socket base, and wrap with glass cloth, MIL-C-20079, type I class 9 (or equal). Inspect to ensure the wires are evenly distributed around the socket basket and flush with the top of the basket. Some protrusion of wires above the basket is acceptable.
10. Before use, thoroughly clean the pot and ladle used to melt and pour the molten zinc of rust, scale, slag, or foreign matter. Use a ladle capable of holding enough zinc so that a complete socket can be poured at one time.
11. Heat zinc and socket to approximate temperatures given in [Table 613-1-4](#). Use zinc, ASTM B6 high grade.

NOTE

Do not use lead, babbitt, solder, or other soft and inferior metals.

Tempilstick can be used to measure preheat temperature of socket. A portable pyrometer can be used to measure correct temperature of molten zinc. Inspect to ensure the zinc and socket are at the correct temperatures given in [Table 613-1-4](#). Failure to properly preheat the socket and control the temperature of the molten zinc can cause incomplete penetration of the zinc through the broomed wires and throughout the length of the basket, resulting in an unacceptable poured socket.

Table 613-1-4. TEMPERATURE CONDITIONS

Wire Rope Size Range (inches)	Socket Preheat Temperature (Degrees F)	Zinc Pouring Temperature (Degrees F)
1/4 to 1/2	500	900
5/8 to 2-1/4	400	900

12. Skim off dross from top of molten zinc before pouring.
13. Pour molten zinc into top of socket basket in one continuous pour until the tops of the wires are covered, as shown in [Figure 613-1-18](#) (5). Some protrusion of wire ends above the zinc is acceptable. Until full, tap

sides of socket lightly, while pouring, to aid molten zinc penetration into crevices between wires and around base of socket. Allow zinc to solidify and air cool slowly. After cooling, remove glass cloth, fire clay, and all seizings. Inspect base of socket for indications of zinc penetration as shown in [Figure 613-1-18](#) (6).

14. All poured sockets that have been poured in accordance with the above procedures shall be pull tested and held for 10 minutes at 40 percent of the minimum breaking strength of the wire rope (i.e., 40 percent of the acceptance breaking strength per FED Spec RR-W-410; see [Table 613-1-1](#) for 6 by 19 and 6 by 37 wire rope). Record of pull test shall be provided by testing activity to the user activity.
15. After the pull test of the assembly has been conducted, visually inspect the socket as shown in [Figure 613-1-19](#), [Figure 613-1-20](#) and [Figure 613-1-21](#). Rework any socket that fails the rejection criteria.
16. The fabricating activity shall clean (see paragraph [613-1.10.4](#) step 3) and dip in lubricating oil (e.g., 2190 TEP) the fitting and an additional foot of wire rope beyond the area cleaned.

NOTE

Aircraft elevator platform end fittings are not required to be pull tested because of system design considerations. For weapons handling systems on submarines, refer to paragraph 700-4.2.7 of **NSTM Chapter 700, Shipboard Ammunition Handling and Stowage** .

S9086-UU-STM-010/CH-613R3

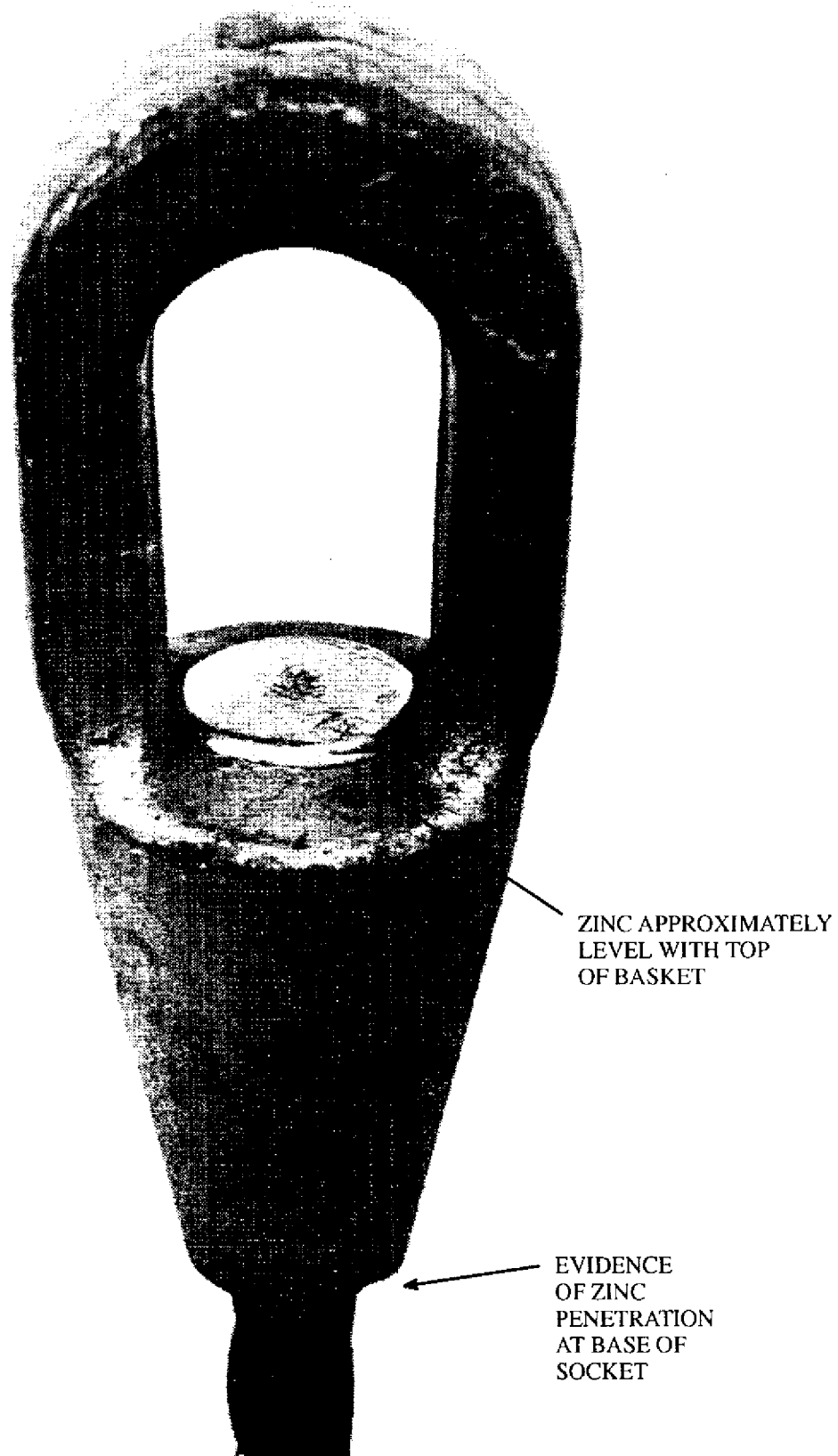

Figure 613-1-19. Level of Poured Zinc and Zinc Penetration

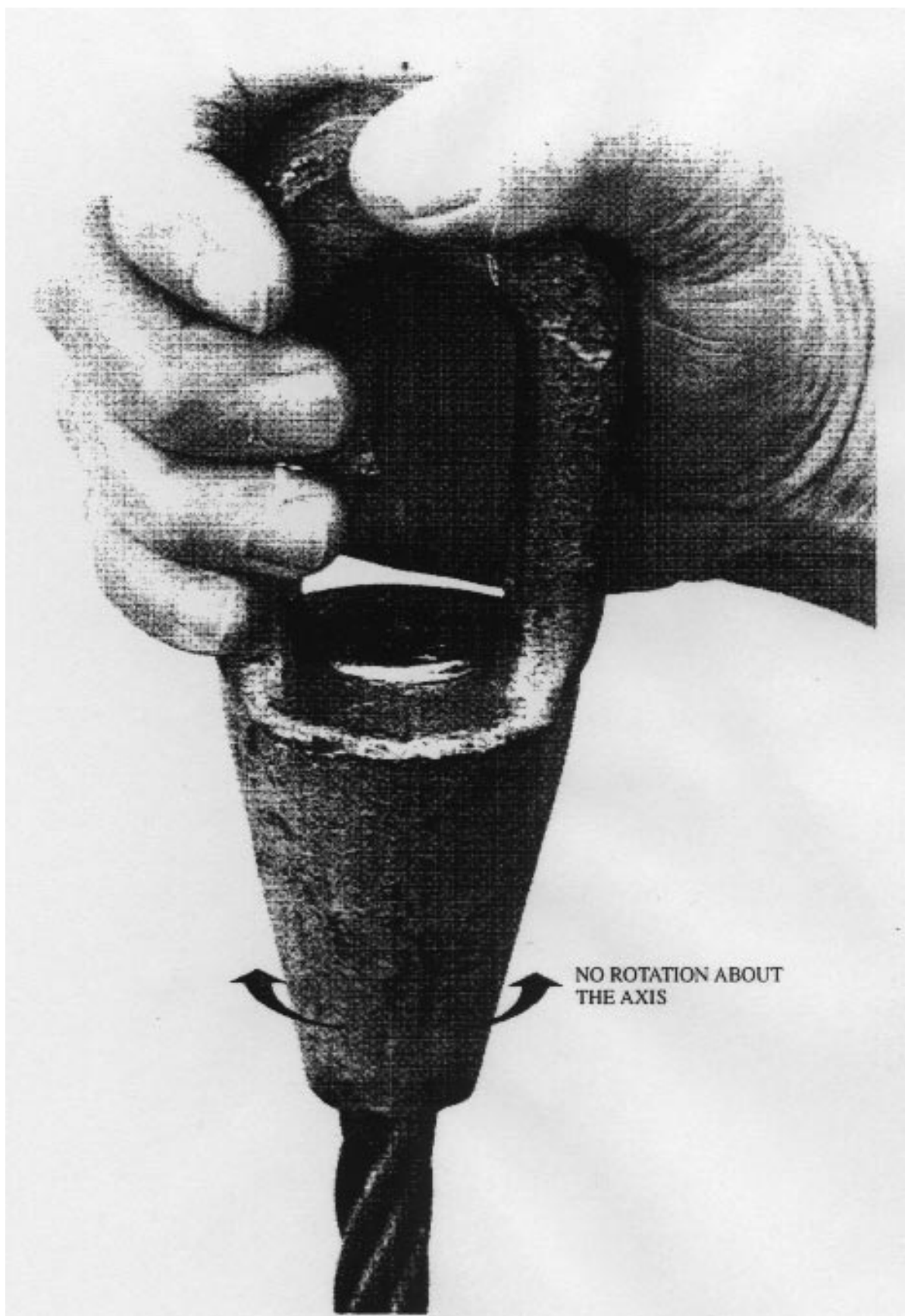

Figure 613-1-20. Rotation of Socket

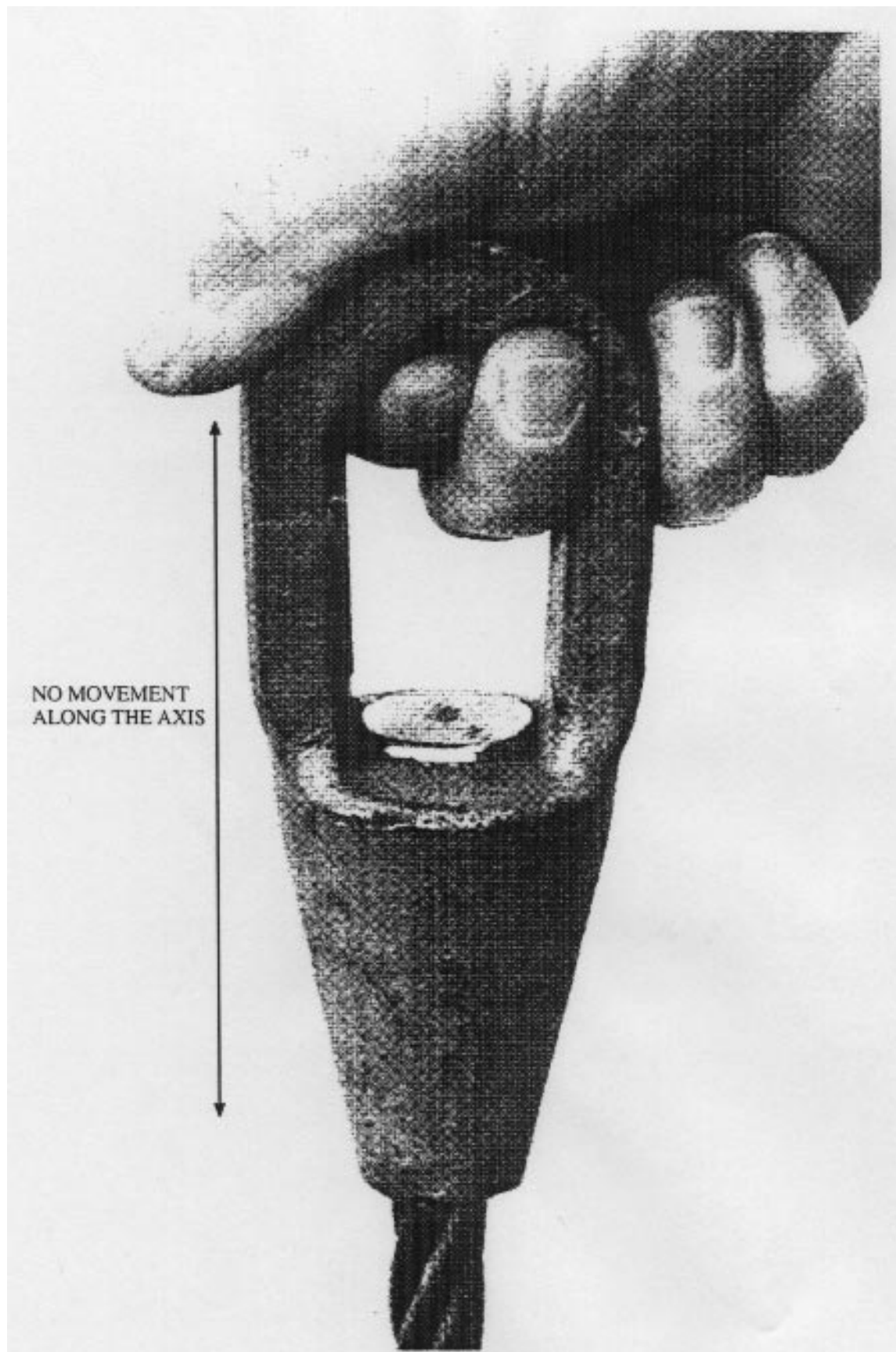

Figure 613-1-21. Axial Movement of Socket

613-1.11.2.4 In-Service Sockets. All in-service poured zinc sockets that are functioning satisfactorily should be considered satisfactory for continued use, provided that the wires at the top part of the basket are covered with zinc and that there is indication that zinc has penetrated to the bottom of the basket. Sockets with some protrusion of wire ends at the top of the basket are also acceptable.

613-1.11.2.5 System Applicability. The information and procedures for installation and testing of wire rope sockets is provided as general guidance. Contact the Life Cycle Engineering Manager (LCEM) or In-Service Engineering Agent (ISEA) to determine applicability to specific systems.

613-1.11.2.6 Reuse of Poured Sockets. Poured sockets are reusable if the following procedures are followed:

1. To remove sockets, assign only those personnel who have completed formal training to perform poured socket installation.
2. Heat socket to approximately 780°F and remove wire rope from socket.

CAUTION

Continue to heat socket to clean remaining zinc from socket basket; temperature of socket shall not exceed 900°F.

3. Visually inspect socket for deterioration, cracks or deformities. When socket is suspected of being defective, perform non-destructive test (NDT) prior to reuse to ensure that socket is satisfactory. Remove questionable sockets from service.

613-1.11.2.7 BRONZE WIRE ROPE WITH BRASS OR BRONZE SOCKET. Follow the procedure described in paragraph [613-1.11.2.3](#) except heat alloy of 60 percent lead with 40 percent tin to not more than 450°F and pour into top of socket basket until basket is full. Preheat the basket to approximately 300°F, taking care not to heat the wires in the rope. After cooling slowly, remove all seizings.

613-1.11.3 POURED RESIN SOCKET. Two resin products, Wirelock and Socketfast, have been approved for use as an alternative to poured zinc for use on wire rope end fittings using spelter sockets. Poured resin sockets can be used for all wire rope connections where the rope end fitting is required to have a strength of 100 percent of the minimum breaking strength of the rope, except for STREAM highlines (see NOTE in [paragraph 613-1.11.2](#)).

613-1.11.3.1 Need for Qualified Assembly Process Control. The strength and durability of a wire rope poured resin socket depends upon careful control of the process of installation as well as familiarity with the procedures described within the following paragraphs. Assign only personnel who have been qualified in accordance with paragraph [613-1.11.3.2](#). Ships and activities that do not have qualified personnel shall not attempt to pour resin wire rope sockets.

613-1.11.3.2 Qualification Requirement.

- a. Initial qualification requires assembly of a rope sling with poured resin sockets at both ends, 1/2 inch diam-

S9086-UU-STM-010/CH-613R3

eter x 72 inches long, using uncoated 6 x 37 EIPS, IWRC rope. The assembly will then be subjected to a pull test to destruction. Failure shall occur in the wire rope at or above FED-SPEC RR-W-410 acceptance breaking strength (26,000 lbs).

- b. Requalification of personnel shall be required upon reporting to a new ship or activity or every three years, whichever occurs first, as long as an individual, once qualified, continues to install sockets. Two people may be qualified (or requalified) on the same destruct test, provided that both were involved hands-on in the installation. Local qualification records shall be maintained at the installation activity.
- c. Installation, testing, training and qualification records are the responsibility of the installing activity. Information recorded should include (at minimum) the following:
 1. Personnel Records — Date qualified, subsequent requalifications, outside training. Activities should keep these records in Personnel Files.
 2. Installation Records — Rope size, description, date assembled, date tested, copy of 40 percent Pull Test Certificate, and description of intended use. Activities shall provide documents to end users and maintain copies of these documents for five years.

613-1.11.3.3 Steel Wire Rope with WIRELOCK or SOCKETFAST Poured Resin Spelter Socket. The following equipment and procedures are recommended as ones that will produce a 100 percent efficient socket connection:

1. Material and Equipment
 - a. WIRELOCK or SOCKETFAST resin kit
 - b. Bucket for Compound mixing (It can be either metal, polyethylene, polypropylene)
 - c. Flat wooden or metal paddle (No other type of stirrer should be used.)
 - d. Seizing Wire ([Table 613-1-3](#)) or Hose Clamps
 - e. Brooming Tool
 - f. Face Shield (safety glasses)
 - g. Protective gloves
 - h. Protective clothing
 - i. Applicable cleaning solvent (Grisolve PEG 2: NSN 6850-01-380-4053 (55 gallon); NSN 6850-01-380-4369 (5 gallon); NSN 6850-01-384-0618(12 boxes of 1 quart) or CITRI-SOLV; NATRA-SOL; Vortex; PF-145 or equal: NSN 7930-01-328-2030)
 - j. Rags
 - k. Fireclay
 - l. Glass Cloth (MIL-C-20079, Type I, Class 9, or equal)
 - m. Cheese cloth
 - n. Booster Packs (Optional and only for WIRELOCK)
 - o. Portable pyrometer
 - q. Soft annealed iron wire.
2. Selection of Socket. The following describes the procedure of selecting a socket:
 - a. WIRELOCK and SOCKETFAST are recommended for use with Crosby 416-417 Spelter Sockets in accordance with FED SPEC RR-S-550.

- b. For use with sockets other than Crosby 416–417, consult the socket manufacturer or manufacturerers of WIRELOCK or SOCKETFAST .
- c. The socket basket should be examined prior to use and loose scale, dirt or grease removed.

WARNING

Do not use oversized sockets for Wire Rope.

3. Preparation of the Boom.

- a. Measure rope ends to be socketed. The rope end should be of sufficient length so that ends of the unlaidd wires (from the strands) will be at the top of the socket basket.
- b. Next apply the seizing, see Figure 613–1–22A, one basket length plus one rope diameter from the end of the rope. The length of the seizing wire must be at least one rope diameter long. Seizing wire should be a soft annealed iron wire.

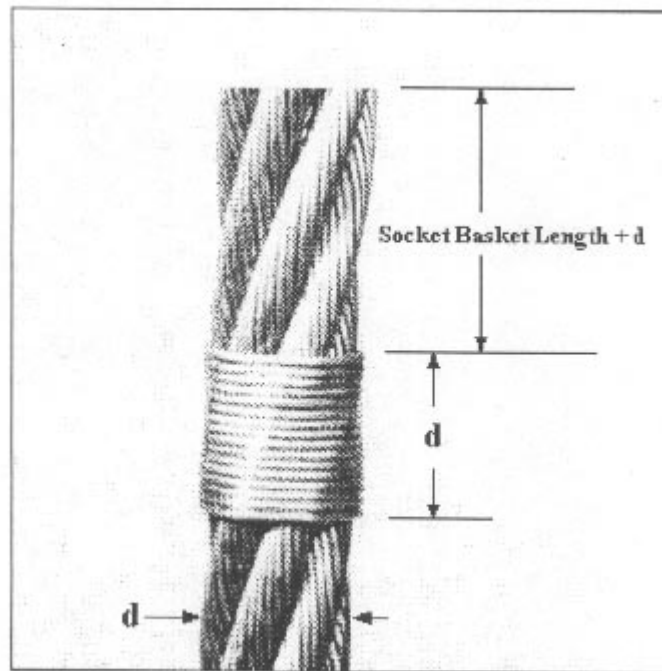

Figure 613-1-22A. Seizing of Wire Rope.

- c. Wire rope must have all plastic material (non-metallic materials) removed from within the broomed area.
- d. Line vise jaws with soft annealed iron wire or copper plates and secure rope directly below the seizing to allow the strands to be unlaidd to the seizing. They should be bent outwards to an included angle not exceeding 60 degrees, see Figure 613–1–23A.

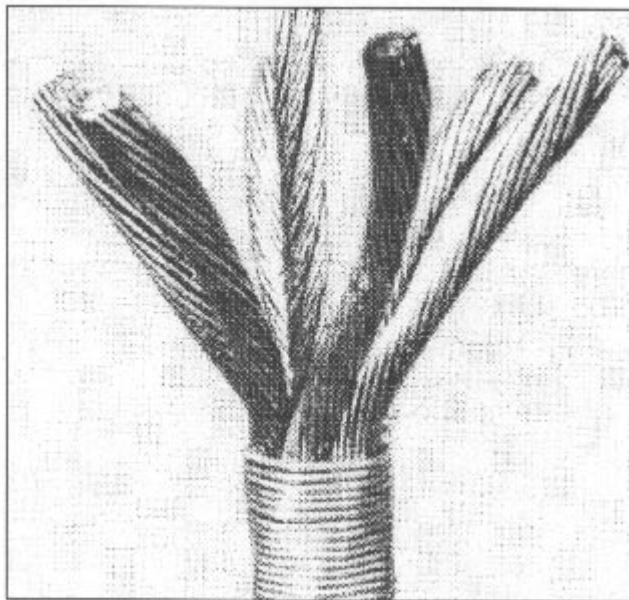

Figure 613-1-23A. Unlay of Wire Rope.

- e. Internal leakage of resin in ropes 3" in. diameter and larger can occur because of gaps between strands and the IWRC (Independent Wire Rope Core). These gaps should be sealed (before brooming) by pushing small plugs of the fireclay down into the served portion.
- f. If the rope has a fibre core, it should be cut out insuring that the remaining fibre core extends 1/2 rope diameter into the bottom of the socket. In the case of fibre cores, resin is the preferred socketing method. If the rope has an IWRC core, do not cut. The IWRC shall be completely unlaidd to form part of the broom.
- g. All the wires in each strand and in the IWRC must be unlaidd completely down to the seizing to form a broom, being careful not to disturb or change the lay of wires and strands under the seizing band. The wires should not be straightened.

NOTE

The wires must be unlaidd from the end of the rope to the seizing because a good fill of resin must occur to the bottom (small end) of the socket. Most of the load capacity of the termination is concentrated in the bottom one third of the socket, see Figure 613-1-24A.

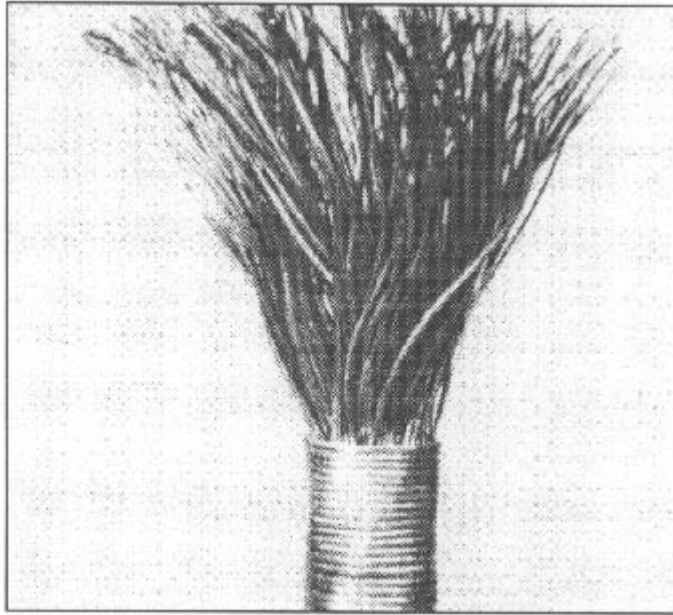

Figure 613-1-24A. Properly Broomed Wire Rope.

- h. Except in the case of wire ropes of coarse construction e.g., 6 x 7, it is not necessary or desirable to hook the wires in the broom. When the rope contains large numbers of wires, hooking the ends causes congestion within the socket and can create penetration problems for the socketing medium although this is less of a problem with the resin than with zinc or white metal.

WARNING

When cleaning wire rope, it is mandatory that safety goggles, gloves and protective clothing be worn. Use a well ventilated area, preferably open air, to reduce the possibility of fume inhalation. See NSTM Chapter 670.

4. Cleaning.

NOTE

For CRES wire, follow cleaning procedures in paragraph 613-1.11.2.3.5.b ensuring that the broomed section of wire rope that was acid washed received a thorough rinse in the washing soda/sodium bicarbonate.

- a. Remove wire rope from vise and clean all broomed out wires with solvent as near as possible to the first seizing.
- b. Dilute the PEG2 solvent with a 1:1 water ratio. (If possible heat the solution between 100°F-110°F).
- c. Submerge wire rope broom in PEG2 bath; the lubricants will float to the surface. Remove the lubricants with cheesecloth.
- d. Dispose of waste material properly.

CAUTION

Be sure that the cleaning is confined to the broom and does not extend to the rope beyond.

WARNING

Do not clean the wire rope broom with acid, soda, methyl hydrate, or acetone. A flux should not be used.

- e. After the wire rope is cleaned, dry with compressed air blasts. After cleaning and drying the wire rope broom, it should be kept in an upright position to prevent any grease from running back down from the main body of the rope and contaminating the clean wires. Care should be taken to prevent any foreign object from collecting onto the cleaned wires that impair the cleanliness required for an efficient socket connection.

5. Positioning of Broom and Alignment of Socket.

- a. Place rope in a vertical position with the broom end up. It is recommended that there be 30 rope diameters below the socket before any bending occurs in the rope.
- b. Temporarily close and compact the broom to permit insertion of the broomed end into the base of the fitting.
- c. Slip socket over seized, broomed out wires and remove end seizing. Ensure wires are distributed evenly around socket basket and flush with top. Ensure socket is in line with axis of rope and rope is in a vertical position, not tilted, Figure 613-1-25A. Seal the base of the socket with fireclay, taking care not to push the material into the socket base, and wrap with glass cloth, MIC-C-20079, type I class 9 (or equal). Inspect to ensure the wires are evenly distributed around the socket basket and flush with the top of the basket. Some protrusion of wires above the basket is acceptable.

NOTE

Make certain the broomed wires are uniformly spaced in the basket, with the wire ends at the top edge of the basket, and that the axes of the rope and the fitting are aligned. A vise should be used to assist in the alignment of the axes of the socket and the rope. Correct alignment will avoid premature failure of the assembly due to unequal loading of the wires, see Figure 613-1-26A.

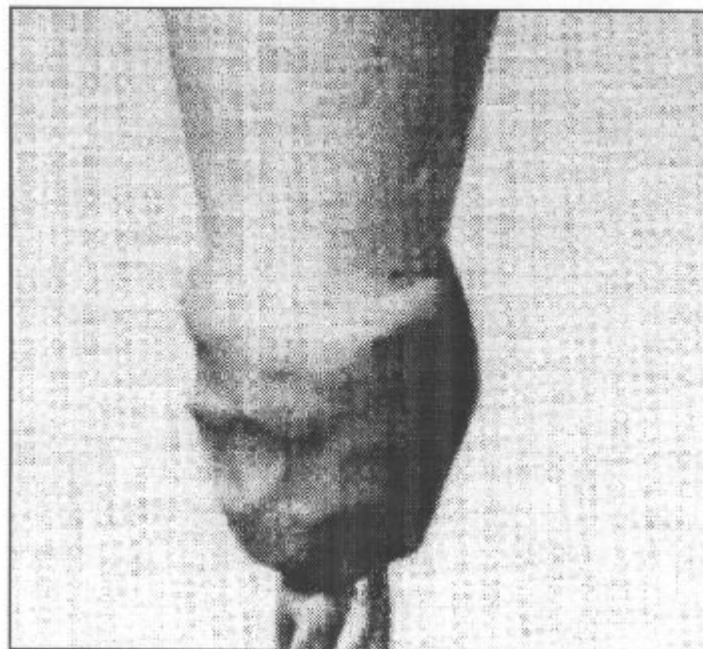

Figure 613-1-25A. Socket Properly Sealed with Fireclay.

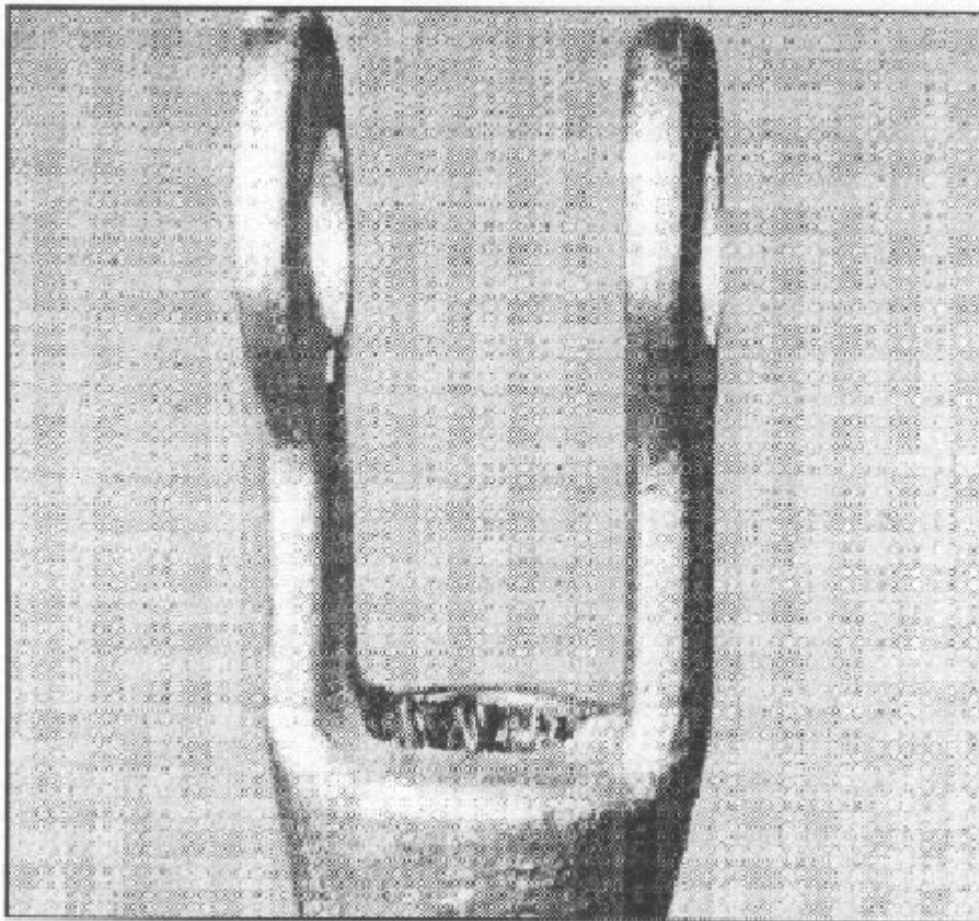

Figure 613-1-26A. Properly Positioned Socket with Wire Rope Ends Protruding.

6. Making WIRELOCK Compound.

- a. WIRELOCK is formulated for mixing and pouring in the ambient temperature range; 27 degrees Fahrenheit (F) to 110 degrees F. At lower temperatures, the gel time will increase with decreasing temperature. Below 48 degrees F the gel time of approximately 20 minutes can be maintained by the use of booster packs. A portable pyrometer can be used to measure correct temperature of the WIRELOCK mixture.

WARNING

Always check expiration date on the cans and never use out of date material. It is mandatory to that safety goggles, gloves and protective clothing be worn. Use only in well ventilated work areas, preferably open air, to reduce the possibility of fume inhalation.

- b. At ambient temperature between 48 degrees F and 35 degrees F, one booster pack should be used. Between 35 degrees F and 27 degrees F, two booster packs should be used. The booster pack compensates chemically for the slower gel time experienced at lower temperatures. In order to comply with all the approvals

granted, WIRELOCK should not be mixed and poured at temperatures below 27 degrees F. Knowing the ambient temperature is useful, however it should be remembered that WIRELOCK will for some time afterwards, tend to cure according to the temperature at which it, the socket and the wire rope were stored. The temperature of the socket and the rope should conform to the temperature at which the WIRELOCK has been stored for at least 24 hours. When the sockets, the rope and WIRELOCK are stored at normal temperatures (65 to 70 degrees F), booster packs must not be used even if the ambient temperature is below 48 degrees F.

- c. WIRELOCK is packaged into three pre-measured kit sizes, 250 cm³ , 500cm³ and 1000 cm³ . The proper size kit should be selected by the size of wire rope being poured. Use [Table 613-1-5A](#) to determine the appropriate sized kit for the size rope being used. It is possible to combine various kit sizes to achieve any required volume, e.g., 2500 cm³ = 1 x 1000 cm³ + 3 x 500 cm³ , etc. In this case, all of the liquid resin should be placed in the mixing container and then all of the powder added to it (or vice versa) before mixing.

NOTE

Always mix all of the resin with all of the powder. Never mix less than the total contents of all cans. Never use styrofoam products as mixing vessels.

- d. Mixing vessels should be clean and a stirrer should be used to mix WIRELOCK , see Figure 613-1-27A.

Table 613-1-5A. Compound Quantities for WIRELOCK

Rope or Strand Size (in.)	cm ³	Rope or Strand Size (in.)	cm ³
1/4	9	1-3/4	700
5/16	17	1-7/8	700
3/8	17	2	1265
7/16	35	2-1/8	1265
1/2	35	2-1/4	1410
9/16	52	2-3/8	1410
5/8	52	2-1/2	1830
3/4	86	2-5/8	1830
7/8	125	2-3/4	2250
1	160	3	3160
1-1/8	210	3-1/4	3795
1-1/4	350	3-1/2	4920
1-3/8	350	3-3/4	5980
1-1/2	420	4	7730
1-5/8	495		

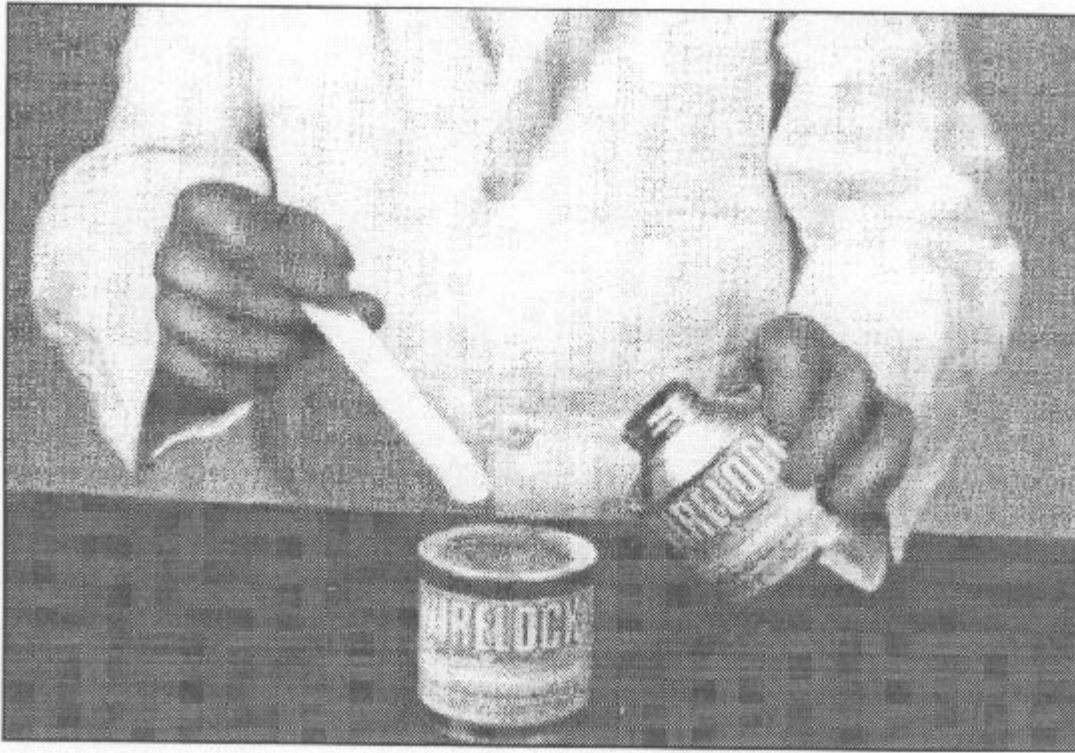

Figure 613-1-27A. Proper Vessel and Wooden Paddle Used in Mixing.

- e. Immediately upon pouring the resin into the granular compound (or vice versa), mix vigorously for two minutes or until a homogenous mixture has been obtained. Make sure that no unmixed compound remains on the bottom of the mixing container. For larger sizes, a mechanical mixer is ideal.

NOTE

Upon mixing, the WIRELOCK will turn to a greenish turquoise color. If the mix remains a pale straw yellow color, do not use the kit. Always mix all of the resin with all of the powder. Never mix less than the total contents of both cans, see Figure 613-1-28A.



Figure 613-1-28A. Proper Mixing of the WIRELOCK Compound.

WARNING

Hot sockets must not be used. Do not apply heat to sockets to accelerate the curing process prior to pouring. The application of external heat may cause the resin to gel before it reaches to the bottom of the socket and lead to assembly failure. Used sockets cleaned out by heating should be allowed to cool to room temperature before re-use.

1. Making SOCKETFAST Compound.

- a. SOCKETFAST is formulated for mixing and pouring where the socket and both liquid components of the SOCKETFAST kit are within 65 degrees Fahrenheit (F) to 90 degrees F. If necessary, warm both sealed liquid components by immersion in hot, but not boiling, water.

CAUTION

Socket temperatures above 100 degrees F may cause premature hardening of the resin.

WARNING

Always check expiration date on the cans and never use out of date material. It is mandatory that safety goggles, gloves and protective clothing be worn. Use only in a well-ventilated work area, preferably open air, to reduce the possibility of fume inhalation.

S9086-UU-STM-010/CH-613R3

- b. SOCKETFAST is packaged in three pre-measured kit sizes, 300 grams (173 cm³ /10.5 in³), 1000 grams (575 cm³ /35.1 in³), and 4000 grams (2,299 cm³ /140.3 in³). The proper size kit should be selected by the size of wire rope being poured. Use [Table 613-1-6A](#) to determine the appropriate size kit for the size rope being used.

NOTE

Always mix the entire quantity of both liquid components. Never mix less than the total contents provided within the kit. Never use styrofoam products as mixing vessels.

- c. Mixing vessels should be clean and a stirrer should be used to mix SOCKETFAST .
- d. With a mixing blade, mix the resin for approximately two minutes, being careful to scrape the sides of the container, to assure a uniform consistency with all filler in suspension.

Table 613-1-6A. Compound Quantities for SOCKETFAST

Rope of Strand Size (in.)	Rope Fittings		
	grams	cm ³	in ³
1/4	15	9	0.5
5/16	30	17	1.1
3/8	30	17	1.1
7/16	60	35	2.1
1/2	60	35	2.1
9/16	90	52	3.2
5/8	90	52	3.2
11/16	—	—	—
3/4	150	86	5.3
7/8	215	125	7.5
1	275	160	9.7
1-1/8	365	210	13
1-1/4	610	350	21.5
1-3/8	610	350	21.5
1-1/2	735	420	26
1-5/8	860	495	30
1-3/4	1220	700	43
1-7/8	1220	700	43
2	2200	1265	78
2-1/8	2200	1265	78
2-1/4	2450	1410	86
2-3/8	2450	1410	86
2-1/2	3180	1830	112
2-5/8	3180	1830	112
2-3/4	3910	2250	137
3	5500	3160	193
3-1/4	6600	3795	232
3-1/2	8560	4920	300
3-3/4	10400	5980	365
4	13450	7730	472

- e. Once the resin has been thoroughly mixed, add all of the catalyst to the container of resin and mix thoroughly, see Figure 613-1-29A.



Figure 613-1-29A. Mixing of the SOCKETFAST Catalyst to Resin Mixture.

NOTE

The large 4000-gram kit should be power mixed, using a 3n electric drill and Jiffy mixing blade.

WARNING

Hot sockets must not be used. Do not apply heat to sockets to accelerate the curing process prior to pouring. The application of external heat may cause the resin to gel before it reaches to the bottom of the socket and lead to assembly failure. Used sockets cleaned out by heating should be allowed to cool to room temperature before re-use.

8. Constructing the Resin Sockets:
 - a. Once either the WIRELOCK or SOCKETFAST compounds are mixed, pouring should begin immediately, see Figure 613-1-30A, into the socket to ensure good penetration, preferably down the side of the socket basket to allow air to escape. Take a stiff wire and slowly work it up and down between the broomed wires at several points to eliminate entrapped air within the socket.

NOTE

Immediate pouring will ensure that the gelling stage occurs in the socket and not in the mixing container.

- b. Do not move newly poured sockets for at least 10 minutes. Movement of the newly poured sockets may damage the soft resin and reduce the efficiency of the termination.

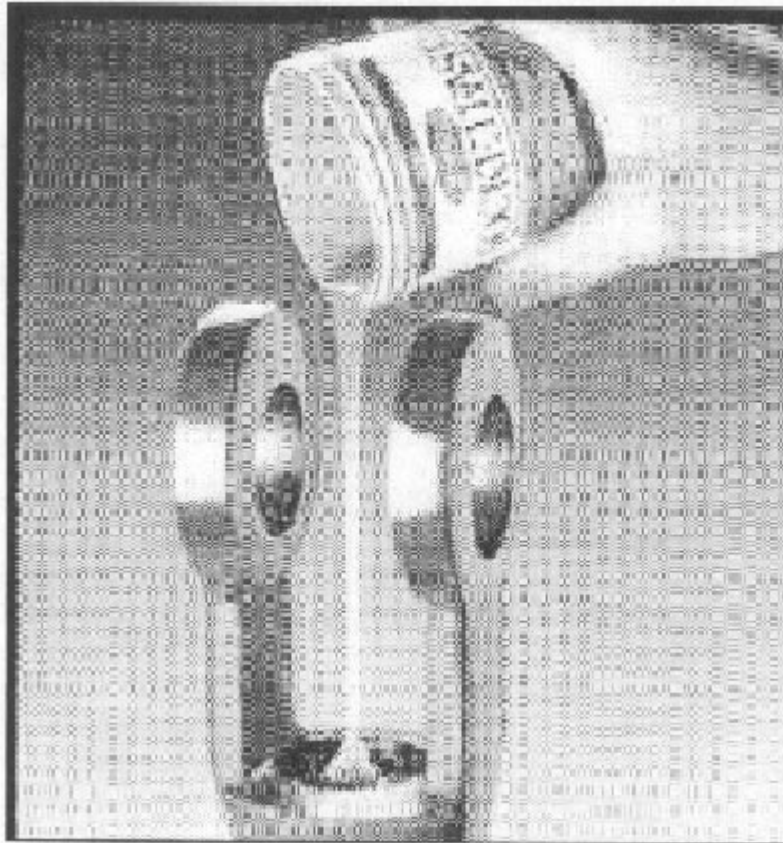

Figure 613-1-30A. Pouring of SOCKETFAST Compound into the Socket.

WARNING

The newly poured sockets should not be moved for a minimum of 10 minutes after the material in the socket has gelled.

- c. Visually check the pour for penetration of the resin into the socket bottom by removing the rope from the vise and removing the fireclay or putty.
- d. After removing the rope from the vise and inspection for penetration, any degreased area of the rope below the socket should be re-lubricated.

WARNING

Do not pull test poured resin sockets until a minimum of one hour has passed since the pour was completed.

- e. Poured resin sockets that have been poured in accordance with the above procedures shall be pull tested

and held for 10 minutes at 40% of the minimum breaking strength of the wire rope (i.e. 40% of the acceptance breaking strength per Fed Spec RR-W-410; (See [Table 613-1-1](#) for 6 x 19 and 6 x 37 wire rope). Testing activity shall provide record of the pull test to the USN activity. The rope can be put into service of proof loaded one hour after the material in the socket has gelled.

- f. After the pull test of the assembly has been conducted, apply wire rope grease (MIL-G-18458) to the rope at the socket base, and on any rope section where the original lubricant may have been removed.

613-1.11.3.4 In-Service Sockets. All in-service poured resin sockets that are functioning satisfactorily should be considered satisfactory for continued use, provided that the wires at the top part of the basket are covered with resin and that there is indication that the resin has penetrated to the bottom of the basket. Sockets with some protrusion of the wire ends at the top of the basket are also acceptable. Cracks that may appear on the top of the cured resin cone are surface crazing only, and are the result of heat stresses upon a thin layer of unreinforced resin covering the tops of the wires. The crazing does not affect the strength of the termination within a socket. Shrinkage of the resin cone may leave a gap between the resin cone and the socket wall. This is normal, particularly with large sockets and high ambient temperatures. This in no way affects the efficiency of the assembly. Upon loading, the resin cone will be seated in the socket.

613-1.11.3.5 System Applicability The information and procedures for assembling and testing wire rope poured resin sockets is provided as general guidance. Contact the Life Cycle Engineering Manager (LCEM) or In-Service Engineering Agent (ISEA) to determine applicability to specific systems. Resin sockets should not be used in environments of strong caustic or acid solutions. Resin sockets are not affected by oils, grease or salt water.

613-1.11.3.6 Re-use of Poured Resin Socket.

1. In order to remove the resin cone, cut the rope close to the nose end of the socket and press the cone out of the socket.

WARNING

Heat is not recommended as a means to remove the resin cone for metallurgical, medical and environmental reasons.

2. When selecting a socket for re-use please follow the following procedures:
 - a. Do not use sockets that show discoloration from excessive heating.
 - b. Do not use sockets that show any sign of welding.
3. Select only sockets that have been cleaned and passed a Magnetic Particle Inspection by a qualified technician and performed in accordance with ASTM E709.
4. Select only sockets that do not show any signs of overloading or wear on the socket pin, i.e., elongated pin holes, undersize pins, etc.
5. Select only sockets that are free from nicks, gouges and abrasions. Indicators may be repaired by lightly grinding until surfaces are smooth provided they do not reduce the dimension by more than 10% of the nominal catalog dimension.
6. Select sockets that are not distorted, bent or deformed. Sockets having these indications shall not be used.

S9086-UU-STM-010/CH-613R3

613-1.11.4 FIEGE-TYPE (THREADED, COMPRESSION) WIRE ROPE CONNECTORS. Fiege-type wire rope connectors (see [Figure 613-1-22](#)) used in the Navy are equal in strength to 85 percent of the acceptance breaking strength of 6 by 19 or 6 by 37, uncoated, improved plow steel, wire rope of the size for which the connector was made ([Table 613-1-1](#)). Typical examples of approved applications for Fiege-type wire rope connectors, wherein the design has provided an adequate safety factor are:

- a. Ship standing rigging
- b. Boat booms
- c. Life lines
- d. Tiller ropes
- e. Towed devices involving use of armored electrical cable
- f. Wire rope antennas
- g. Cargo and weapons elevators.

613-1.11.4.1 Parts. Fiege-type wire rope connectors are made of three parts. They include a sleeve which slips over the end of the wire rope, a plug which is inserted to separate and hold the strands of the wire in the sleeve, and a covering socket. This combination locks onto the rope to make a strong flexible connection. Different type plugs, as shown in [Figure 613-1-22](#), are provided for use with different types of wire rope. If the fitting is to be used on a wire center rope or on a strand, the order for the fitting shall indicate the type plug to be furnished.

613-1.11.4.2 Installation. Use the procedure in [Figure 613-1-22](#) for installing Fiege-Type wire rope connectors. [Figure 613-1-22](#) shall be incorporated, without change or deviation, into a serialized Controlled Work Package (CWP) for each assembly.

NOTE

Wire rope must be visible through the inspection hole of the Fiege fitting after installation and at all times while in service.

TOOLS, PARTS AND MATERIALS REQUIRED:

- Electroline Fiege fitting (sleeve, socket and plug, View 1).

Note: If an existing fitting is being reused a new plug is still required.

- Tube driver, Steel (View 2).

Note: The hole diameter is 1/32 of an inch larger than the wire rope core diameter. The tube driver is available from Electroline.

- Wire rope assembly block, steel (View 3).

Note: The hole diameter is 1/32 of an inch smaller than the rope diameter. The assembly block is available from Electroline.

- Vise
- Hammer
- Torque bar
- Marline spike
- Knife

STEP ONE:

- A. Identify the size and type of wire rope construction you are using.
- B. Select the proper size and type of sleeve, plug and socket for the wire rope being used.
- C. Select the proper size assembly block and tube driver.
- D. Cut the wire rope at the desired point of attachment.
- E. Place the assembly blocks around the wire rope and place in the vise. Allow wire rope to extend beyond the top of the assembly block (View 4) the distance specified in Table 1 and tighten the vise.
- F. **For fiber core wire rope only!** Insert the marlinespike between the rope wire strands to unlay and pry out the fiber core. Cut the fiber core as close to the assembly block as possible. Push the fiber stub back into the center of the wire rope. Close the wire rope strands.
- G. Install the sleeve by twisting the sleeve over the wire rope until it sets on the assembly block (View 5).
- H. Measure and adjust the wire rope to allow the wire rope to extend above the sleeve (View 5) the required distance specified in Table 1.
- I. Tighten the vise to secure the wire rope in place.

STEP TWO: (View 6)

- A. Unlay the strands of the wire rope using the marlinespike. Do not attempt to straighten the spiral lay of the strands
 - B. **For wire core rope 1/4 inch or smaller only!** Broom out the core wires uniformly.
- CAUTION: ONLY USE NEW PLUGS WHEN ASSEMBLING FIEGE FITTINGS. USED FIEGE PLUGS DISTORT DURING USE AND THE HOLDING STRENGTH OF THE FITTING MAY BE REDUCED.**
- C. Recheck the "B" dimension.
 - D. Insert the plug at the center of the wire rope. Using the tube driver, start the plug by tapping it down into the sleeve, taking care that each strand falls into its respective groove if applicable. Using the tube driver, drive the plug down to a solid seat.

STEP THREE: (View 7)

- A. Compress the strands of the wire rope inward toward the center to allow attaching the socket.
 - B. Release the wire rope and assembly block from the vise. Remove the assembly block and reposition the sleeve in the vise to allow it to clamp onto the integral nut surfaces of the sleeve and tighten the vise.
 - C. Install the socket by twisting it over the wire rope strands until it engages the threads of the sleeve. Begin to thread the socket onto the sleeve taking care so not to cross thread them.
- CAUTION: IF THE SOCKET IS NOT FULLY TIGHTENED ONTO THE SLEEVE THE HOLDING STRENGTH OF THE FITTING MAY BE AFFECTED.**
- D. Tighten the socket securely onto the sleeve. A fitting is properly tightened when between 2 to 4 threads remain exposed.
 - E. Inspect the fitting for proper assembly, verify that the wire rope is visible through the inspection hole. If wire rope is not visible through inspection hole then repeat steps One through Three.

Figure 613-1-22. Fiege-Type Electroline (Threaded Compression) Assembly (Sheet 1 of 3)

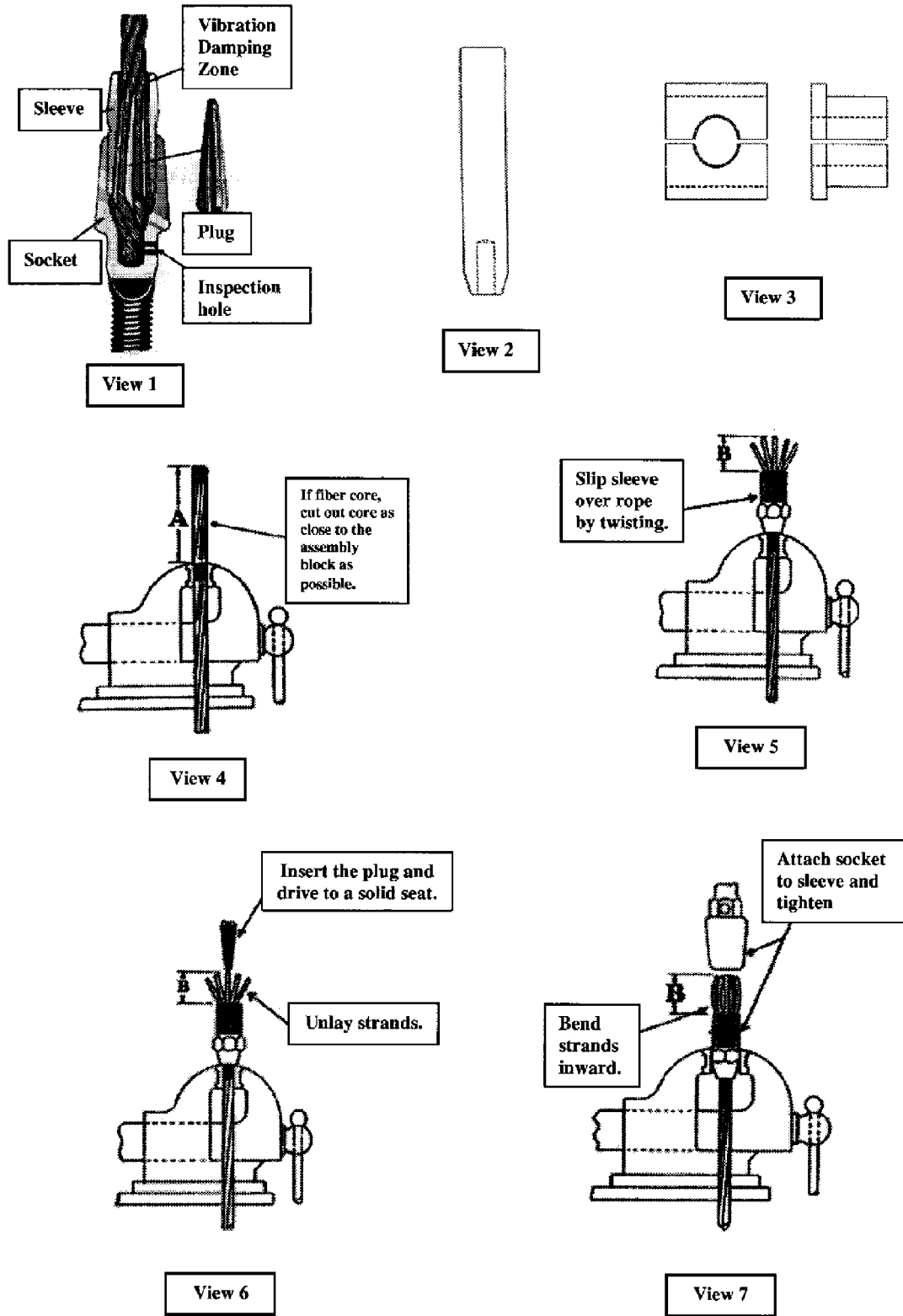

Figure 613-1-22. Fiege-Type Electroline (Threaded Compression) Assembly (Sheet 2 of 3)

TABLE 1				
Wire Rope	All Strands		8 Strand	
Size	(other than 8 strand)		fiber or wire core	
	fiber or wire core			
	A	B	A	B
1/16"	1-13/32"	9/16"		
3/32"	1-9/16"	5/8"		
1/8"	1-9/16"	5/8"		
5/32"	1-31/32"	3/4"		
3/16"	1-31/32"	3/4"		
7/32"	2-3/16"	13/16"		
1/4"	2-1/4"	13/16"	2-3/8"	15/16"
5/16"	2-3/4"	1"	2-15/16"	1-3/16"
3/8"	3-1/8"	1-1/8"	3-15/16"	1-5/16"
7/16"	3-5/8"	1-15/16"	3-7/8"	1-9/16"
1/2"	4-1/8"	1-1/2"	4-3/8"	1-3/4"
9/16"	4-3/4"	1-5/8"	5-1/16"	1-15/16"
5/8"	4-3/4"	1-5/8"	5-1/16"	1-15/16"
3/4"	5-1/2"	1-7/8"	5-7/8"	2-1/4"
7/8"	6-1/2"	2-1/4"	6-15/16"	2-11/16"
1"	7-7/8"	2-3/4"	8-3/8"	3-1/4"
1-1/8"	9-3/8"	3-1/8"	10"	3-3/4"
1-1/4"	11-1/8"	3-5/8"	11-7/8"	4-3/8"
1-3/8"	13-5/16"	4-5/16"	14-1/4"	5-1/4"
1 1/2"	15-1/2"	5-1/8"	16-1/8"	6-1/8"

Figure 613-1-22. Fiege-Type Electroline (Threaded Compression) Assembly (Sheet 3 of 3)

613-1.11.5 WIRE ROPE CLIPS. Wire rope clips are not recommended for permanent connections. The efficiency of a carefully made clip connection is approximately 80 percent of the minimum (acceptance) breaking strength of the wire rope used. The efficiency may be less than this amount if an insufficient number of clips is used, if the nuts are not properly set up, or if the base is not placed on the long end of the rope.

613-1.11.5.1 Installation. [Figure 613-1-23](#) illustrates that the correct way of making clip attachments is to place all of the U-bolts on the short or dead end of the rope. This is to protect the live or stress-bearing end of the rope against crushing and abuse. The flat bearing seat and extended prongs of the body are designed to protect the rope and are always placed against the live end.

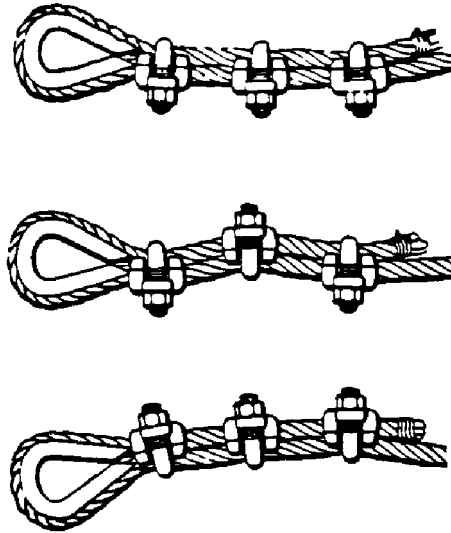

Figure 613-1-23. Clip Attachments

- a. [Table 613-1-5](#) gives the minimum number of clips recommended for satisfactory attachment. It is possible to hold a wire rope by using fewer number of clips than recommended. To do this, however, it will be necessary to apply greater pressure per clip, therefore increasing the abuse to the rope by the U-bolt with corresponding decrease in the efficiency of the attachment.

Table 613-1-5. MINIMUM NUMBER OF CLIPS REQUIRED

Rope Diameter (inches)	Short Splice		Long Splice
	All 6 x 7 Ropes; All Ropes with Independent Wire Rope Centers	All 6 x 19 and 6 x 37 Rope	Proper Torque To Be Applied To Nuts Of Clips [ft/lb (Dry)]
3/8	4	3	45
1/2	4	3	65
5/8	4	3	95
3/4	5	4	130
7/8	5	4	225
1	6	5	225
1-1/8	6	5	225
1-1/4	7	6	360
1-3/8	7	6	360
1-1/2	8	7	360
1-3/4	8	7	590

S9086-UU-STM-010/CH-613R3

- b. The spacing, or distance between centerlines of clips, does not appear to be a factor affecting the efficiency of clip connections; spacing of six rope diameters is considered suitable.
- c. To secure the best results from any clip attachment and as a safety measure, it is very important to retighten all clips after an hour's full running time as well as at all regular inspections. The tendency of the clips to loosen is due to compression of the rope under operating tension.
- d. After clips have been installed on the same rope for a comparatively long time, it is advisable to remove them and to examine the rope underneath for the presence of broken wires. If any are found, cut the damaged part from the rope and make a new attachment.

613-1.11.6 SWAGING. This includes the making of splices in wire rope by pressing a metal sleeve around wire rope using a hydraulic press for large diameter wire rope and the use of a hand operated device for small diameter wire rope. Swaging is an approved alternate to manual splicing. Swaged fittings shall be pull tested to 40 percent of the minimum breaking strength of the wire rope (i.e., 40 percent of the acceptance breaking strength per RR-W-410) and held for 10 minutes.

613-1.11.6.1 Qualified Personnel. Assign only qualified personnel who have completed formal training to perform mechanical swaging.

613-1.11.6.2 Swaging Qualification. Qualifications and procedures for swaging consist of a pull test to destruction. Failure shall occur in the wire rope at or above FED Spec RR-W-410 acceptance breaking strength. (For 6 by 37 wire rope, see [Table 613-1-1](#).)

- a. Initial qualification requires assembly of a rope sling with sleeves at either end, 1/2 inch diameter x 72 inches long, using 1/2 inch 6 x 37 EIPS, IWRC rope. The assembly will then be subjected to a pull test to destruction. Failure shall occur at 85 percent or more of the acceptance breaking strength of the wire rope, FED Spec RR-W-410. (For 6 by 37 wire rope, see [Table 613-1-1](#).)
- b. Requalification of personnel shall be required upon reporting to a new ship or activity or every three years, whichever occurs first, as long as an individual, once qualified, continues to install swage sleeves.

613-1.11.6.3 Installation. Use the following procedures for installing swage sleeves:

- 1. Currently only stainless steel sleeves are used for swaging. Fittings shall be compatible with swaging dies and are not interchangeable.
- 2. Select proper size dies.
- 3. Inspect dies for wear using die gauges to ensure dies are in good condition.
- 4. Lubricate dies using MIL-G-23549 grease (or equal).
- 5. Insert wire rope into fitting and adjust eye to desired dimension.
- 6. Place swage fitting in dies and close dies. Ensure pressure and swaging techniques are applied according to the manufacturer's operating manual for the particular swaging device or machine.
- 7. Remove completed splice from machine.
- 8. Pull test to 40 percent of wire rope acceptance breaking strength and hold for 10 minutes.

NOTE

Swaging of wire rope with fiber core is not recommended.

613-1.11.7 SPLICING. The making of wire rope splices requires mechanical skill and a facility for handling tools. The higher degree of skill and care employed, the more satisfactory the result will be. Those who are entirely lacking in experience shall make several practice splices before attempting to splice a rope which will be subjected to severe conditions in actual use. If the first effort fails to produce a good result, a review of the work, comparing it step-by-step with the illustrations and instructions, will show where the mistake was made and indicate what to avoid in the future. It is extremely important in making a splice to use great care in laying the various rope strands firmly into position. If, during any of the various operations, any of the strands are not pulled tightly into their respective places in the finished splice, it is doubtful that satisfactory results will be obtained.

613-1.11.7.1 Types of Splicing. Three types of splices are commonly used for wire ropes; the short splice for joining two wire ropes end-to-end under ordinary conditions; the long splice for joining two wire ropes end-to-end for haulages, inclines, or where no increase in the wire diameter is allowed; and the eye splice for installing thimbles or soft eyes permanently into the ends of the wire rope.

613-1.11.7.2 Rope Length Requirements. [Table 613-1-6](#) gives the distance to unlay and the length of tuck recommended for both short and long splices in regular lay ropes. For long lay ropes, increase both of these values 20 percent over those specified.

Table 613-1-6. LENGTH OF UNLAYED ROPE REQUIRED

Rope Diameter (inches)	Short Splice		Long Splice	
	Distance to Unlay (feet)	Length of Tuck (inches)	Distance to Unlay (feet)	Length of Tuck (inches)
1/4	7	10	15	15
3/8	8	12	18	18
1/2	9	14	21	21
5/8	10	16	24	24
3/4	11	18	27	27
7/8	12	20	30	30
1	13	22	33	33
1-1/8	14	24	36	36
1-1/4	15	26	39	39
1-3/8	16	28	42	42
1-1/2	17	30	45	45

613-1.11.7.3 Short Splice.

1. Measure back from the ends of each rope as specified in [Table 613-1-6](#) and place temporary seizings to prevent the ropes from unlaying further back.
2. Unlay the strands of each rope back to the first seizing, taping the end of each strand.
3. Cut the core out from each rope close to the seizing. Force the two ropes together, as close as possible, alternating the strands. Seize both ropes together.

4. Place the ropes into a vise with the seizing holding the two ropes together secured at the edge of the vise jaws. Remove the temporary seizing from the rope protruding from the vise; insert a spike through the rope, going under two of the strands.
5. Take the corresponding strand from the opposite rope and tuck it over one, and under the two open strands against the lay. Repeat this step with the five remaining strands in succession; continue until each strand has been tucked a total of four times.
6. Dropping half of each strand, tuck the remaining halves an additional two times. Cut off all loose wires.
7. Turn rope and repeat steps four through six for the strands in the opposite rope.
8. Beat out splice with a mallet working from the center towards the ends, giving you a completed splice. Such a splice develops up to 95 percent of the strength of the rope as an eye splice described in paragraph 613-1.11.7.7.

613-1.11.7.4 Long Splice. The long splice is used for six-strand regular and lang lay fiber core rope, and develops practically the full strength of the rope. The following procedures describe how the splice is made:

1. Measure back from each of the two ends to be spliced, a distance 8 to 10 inches more than that indicated in Table 613-1-6. At these points, marked D in Figure 613-1-24, place three seizings of wire firmly around the rope to prevent the strands from unlaying further back.
2. Unlay three alternate strands at each end back to the seizings. It is important that the strands be alternate. Assume them to be numbered for the end of one rope and lettered for the other, as shown in Figure 613-1-25. Unlay either strands 1, 3, and 5; 2, 4, and 6; A, C, and E; or B, D, and F.

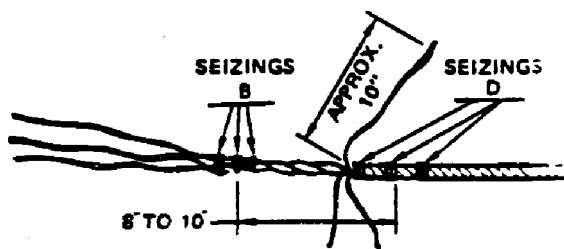

Figure 613-1-24. Seizing Long Splice

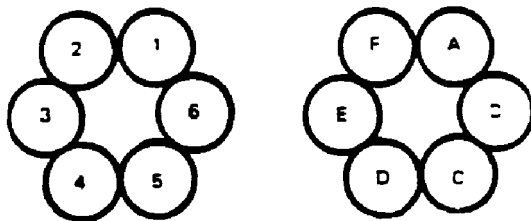

Figure 613-1-25. Strand Identification

3. Cut off the three unlayed strands for each end of the rope 8 to 10 inches from seizing D (Figure 613-1-28).
4. Apply three more seizings of wire at point B in Figure 613-1-26 in order to hold the three strands which have not been unlayed firmly in place. Then separate these three strands as far as seizings B, and cut off the fiber core close to the first of seizings B.

5. Place one end of the rope securely in a vise and assemble the other end so that corresponding strands from each end interlock regularly with each other in a manner similar to that in which the fingers will interlock when those of one hand are pushed between those of the other. It is extremely important that the two ends of rope be forced firmly against each other and be held in this manner until step 9 has been completed. It is advisable, therefore, for one person to hold the ropes tightly together while two others do the splicing.
6. Apply seizing F (Figure 613-1-26), so as to bind the two ropes firmly together.
7. Remove seizings B and D which are to the left of seizing F (Figure 613-1-26).
8. Unlay any one strand A (Figure 613-1-26) and follow up with strand number 1 from the other end, laying strand 1 tightly in the open groove left by the unwinding of A. Make the twist of strand 1 agree exactly with the lay of the open groove. One person shall rotate the strand being laid in as he passes it around the rope in a direction which will tighten the wires. If the proper twist is kept by the person holding the end, little effort is required by the one actually laying the strand in the rope. Forcing the strands in place may result in a poor splice.
9. When all but a short end of strand 1 has been laid in, cut off strand A, leaving an end equal to the length of strand 1 (Figure 613-1-27). These lengths are given under Length of Tuck in Table 613-1-6. After this stage has been reached, it is no longer necessary for one person to hold the two ends of rope together, since the splice will be sufficiently formed to prevent slippage.

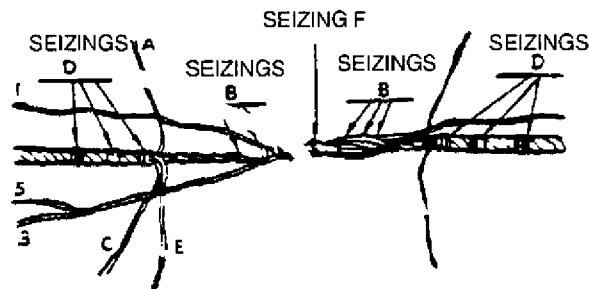

Figure 613-1-26. Relaying Strands

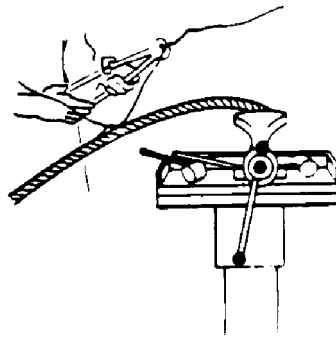

Figure 613-1-27. Cutting Strand Length

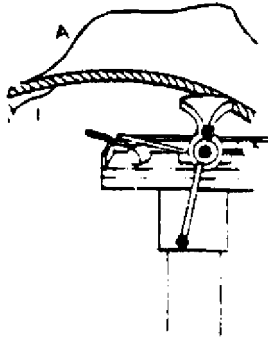

Figure 613-1-28. Binding the Long Splice

10. Unlay strand C in the same manner as A was unlayed and follow up with strand 3, stopping back of the ends of A and 1. Cut off strands C and 3 as A was cut, leaving two short ends C and 3, equal in length to those of A and 1.
11. Repeat step 10 for strands E and 5. [Figure 613-1-29](#) (A) shows the relative positions of strands A and 1, C and 3, and E and 5 with respect to each other. Uniformly space the points where the ends project over the length of the splice.
12. Repeat steps 8 through 11 for the three pairs of strands on the other side to be laid in the same way. When all six pairs have been laid in as directed, the splice will appear as illustrated in [Figure 613-1-29](#) (B). There are six places at which the ends of the strands extend. Tuck these ends without increasing the rope's diameter.
13. Place the rope in a vise at the point where strands A and 1 extend as shown in [Figure 613-1-30](#) (A).
14. Wrap an endless piece of fiber rope around the wire rope as shown in [Figure 613-1-30](#) (B) and insert a pipe in the loop. Pull the end of the pipe so that the wire rope will be unlayed between the vise and the pipe and insert the point of a spike under two strands.
15. Use the spike to force the fiber core into such a position that it may be cut ([Figure 613-1-31](#)). The end of strand 1, which is to be laid in, is bent back towards the vise. Give this strand one full twist so as to loosen the wires where the strand leaves the vise. This makes the strand mushy at this point so that when the tuck is made, the two strands become merged and do not cause a bulge in the rope.

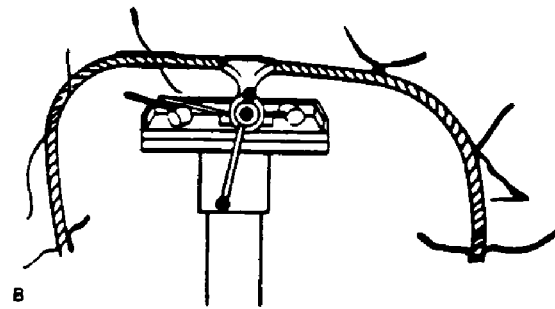
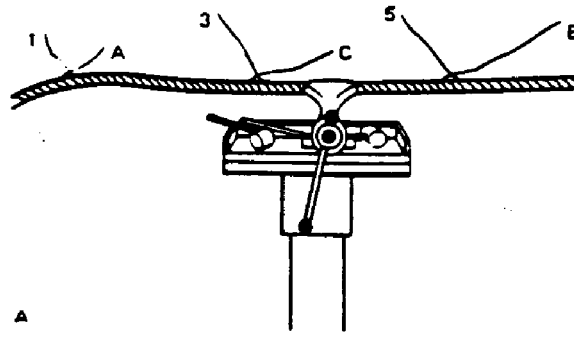

Figure 613-1-29. Long Splice Tuck Points

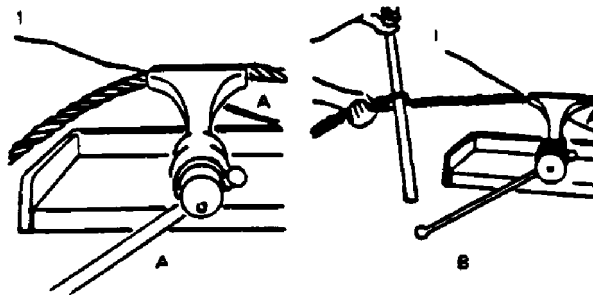

Figure 613-1-30. Preparing for Tuck

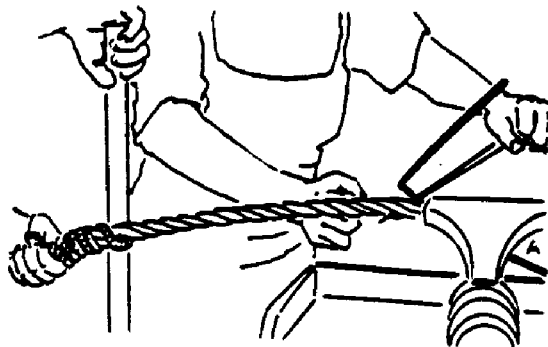

Figure 613-1-31. Cutting the Core

16. In addition to removing one complete twist, straighten the strand and remove its curvature. The strands of a preformed rope have more curvature than those of a standard rope. This makes it more difficult to straighten preformed strands. Take special care to remove the curvature from the strands when splicing preformed rope.
17. After the fiber core has been cut, remove it for a distance equal to the length of the projecting end of the strand. This may be done by moving the spike along the rope with one hand while the other removes the fiber core. Place the spike under two strands of the rope as shown in [Figure 613-1-32](#).
18. Place two seizings on the end of strand 1 to compensate for the difference in size between the fiber core that has been taken out and the strand that is to be laid in. In this way the same rope diameter in the finished splice is maintained. The size of seizing wire to be used for this purpose shall be as large as possible without causing any appreciable increase in rope diameter in the finished splice. Each of these seizings shall be about 1 inch long and spaced 2 inches apart.
19. Insert spike so that it will be over the projecting end and under the next two strands of the rope. Pull the spike toward you. This will cause it to travel along the rope, leaving an opening in front. While one hand is employed in moving the spike, the other hand holding the end of the strand shall lay this end into the opening as indicated in [Figure 631-1-33](#).
20. [Figure 613-1-39](#) shows the rope after the end of strand 1 has been laid in place. The splice is now ready to make the tucks. The success of the splice depends more on this operation than any other in the whole splice. In a regular lay rope the tucked strands shall lie side-by-side where they disappear into the core of the rope. Do not cross the strands. The reverse is the case with a lang lay rope. Cross the strands before tucking. This difference is made between lang lay and regular lay ropes so as to permit the wires to mesh together where the twist is removed. Maximum holding power is obtained in this manner and the tendency of the rope to bulge at the tucks is reduced. If the strands are not laid together properly, they will not mesh into each other. A rough splice will result and its holding power will be impaired.
21. After the ends have been tucked, cut off the projecting ends of fiber core. Hammer down any inequalities with a mallet ([Figure 613-1-35](#)). When all the strands have been laid on the rope as described, the splice is complete. With practice, a splice can be made which will be impossible to detect after the rope has been running a day or two.

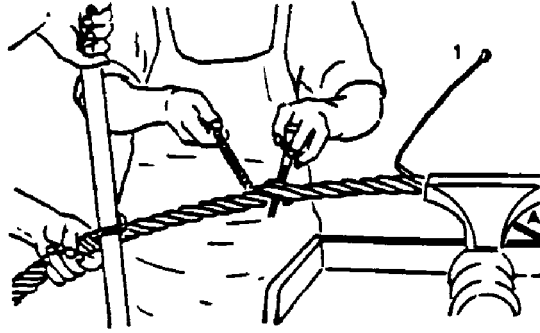

Figure 613-1-32. Removing the Core

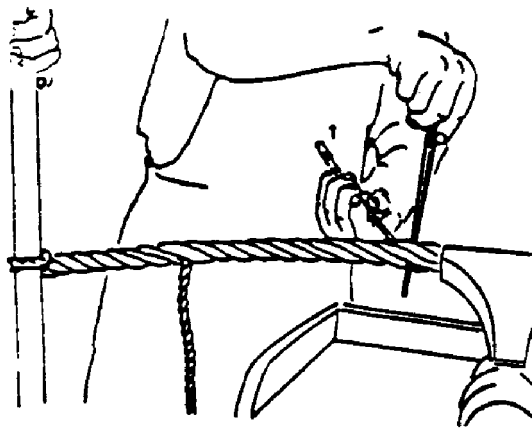

Figure 613-1-33. Laying in Strand

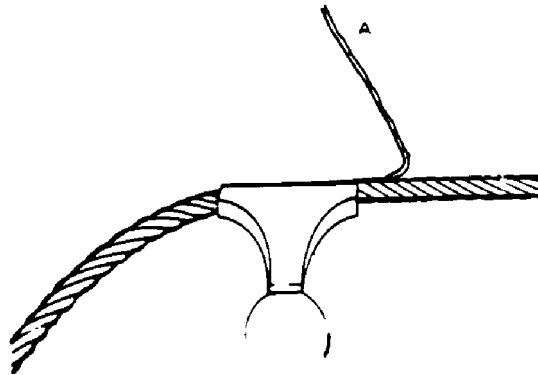

Figure 613-1-34. Rope Ready for Tucking

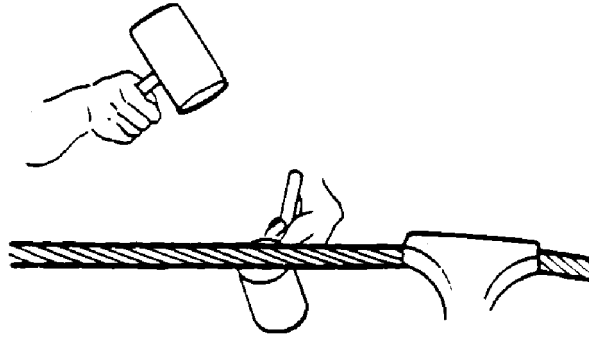

Figure 613-1-35. Finishing

613-1.11.7.5 Independent Wire Rope Core Splice Frequently, it is desirable to splice a rope with an independent wire rope core (IWRC). This is done in the same manner as that employed when long splicing fiber core rope (paragraph 613-1.11.7.4). Study the long splice before proceeding with the directions. The difference in the two splices is in the method of removing the core.

1. In making the splice, the rope ends are first prepared for butting. The strands are then laid in and cut to length before tucking so that they will butt when tucked in to replace the IWRC. Before tucking, the strands are wrapped with friction tape to make them approximately the same diameter as the core. The tape should extend to within 4 inches of the ends of the strands. At that point two seizings are applied, each about 1 inch wide and spaced 2 inches apart. The diameter of seizing wire is as large as possible without causing any appreciable increase in rope diameter after the tucking is completed.
2. The IWRC is cut in two places. In making the cuts, take care to seize the IWRC with annealed iron wire to prevent the core from unlaying. By referring to the accompanying illustrations and following the directions, an efficient splice can be made. Strictly follow the number and method of application of seizings. When this is done, very little difficulty is experienced in making the splice.

613-1.11.7.6 IWRC Splicing Procedures. The procedure for making an IWRC splice is as follows:

1. Prepare the rope ends as described in paragraph 613-1.11.7.4 steps 1 through 3.
2. Figure 613-1-36 (A) shows one end prepared for butting; prepare the other end in the same manner. Apply three seizings at point B after alternate strands 2, 4, and 6 have been unlaid and before strands 1, 3, and 5 can unlaid. Seize strands 2, 4, and 6 and cut as shown in Figure 613-1-36 (A). Seize and cut the IWRC, Figure 613-1-36 (B-7), to a length of 6 to 8 inches. Bend the core back at right angles.
3. Butt the two rope ends. Ensure that the ends of the IWRC (7) project on opposite sides. Under no circumstances shall the core ends project between the same two strands. Apply seizing at point A to prevent ends from backing out.
4. Remove seizings B and D on one side of point A, and lay in strands 1, 3, and 5 on that side in the places provided by unlaid strands 2, 4, and 6. Repeat the same procedure on the other side of point A. Induce a twist to tighten up the wires in the strands as they are laid in so that they will hold their proper position in the rope.
5. Figure 613-1-37 shows the first point of tuck Aa on either side of original point A. There are three such points of tuck (Aa, Ab, Ac, Figure 613-1-38) on either side of the original point A. All of these points of tuck are spaced equidistant. Note how strands are locked in position (Figure 613-1-37) before tucking, and also that

they are cut to length L to enable them to butt when tucked. This is done so that the core will be replaced entirely by the strands making only two cuts of the core necessary.

6. Remove IWRC (7) and tuck. Refer to [Figure 613-1-31](#), [Figure 613-1-32](#), and [Figure 613-1-39](#). Tuck strand 2, to the right of point A, in place of the core 7 which is removed to point Aa. Strand 1, which is the next to be tucked, is bent back (as is done with each strand) and given one turn in a direction to untwist the wires in the strand. Strand 1 is then tucked after the core 7 has been removed to the next point of tuck.
7. Complete tucks at points Aa and Ab on one side of point A. The last tuck at point Ac is ready to be made ([Figure 613-1-40](#)). Note that the IWRC (7) is cut so as to butt against strand end 5, and that seizing is applied to the IWRC (7) before it is cut. Observe that the tucked strands replace the IWRC entirely and only two cuts are required, one at each end of the splice. Tucks are made in the same way on the other side of point A.
8. [Figure 613-1-41](#) illustrates the finished splice at point A where ends of rope were butted, and points of tucks Aa which are adjacent to point A.

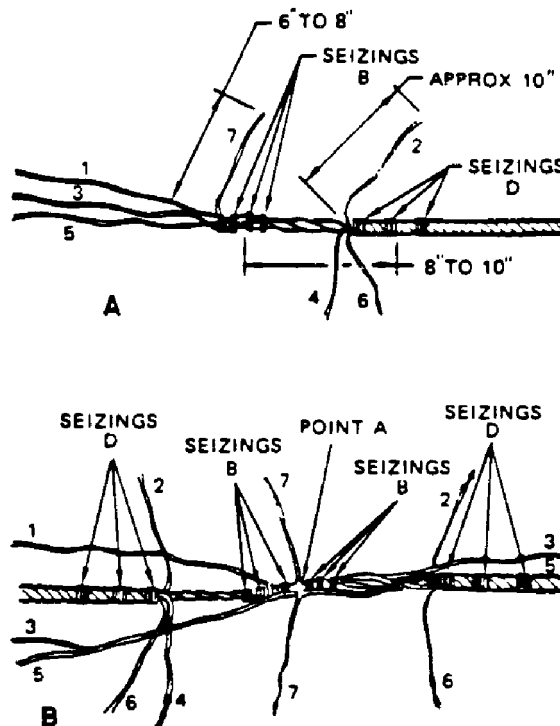

Figure 613-1-36. Butting IWRC Splice

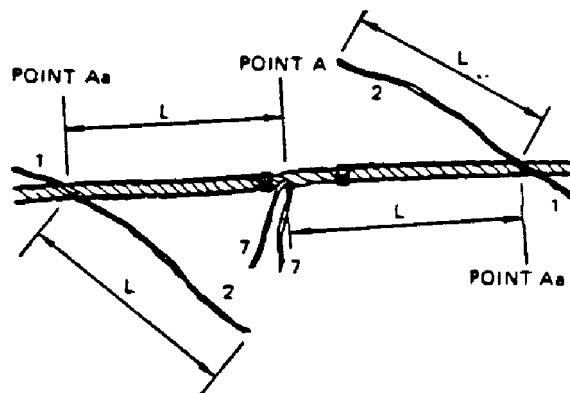

Figure 613-1-37. Initial Tuck Point

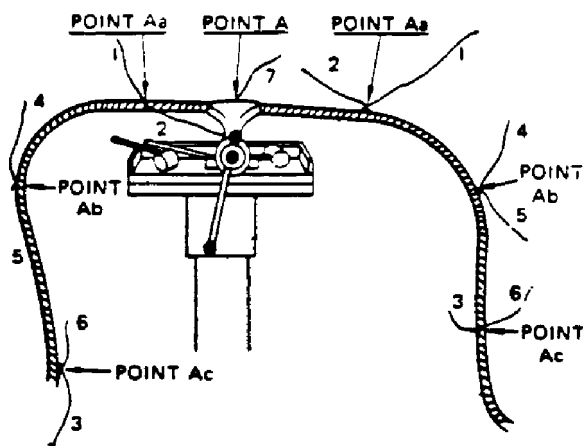

Figure 613-1-38. IWRC Tuck Points

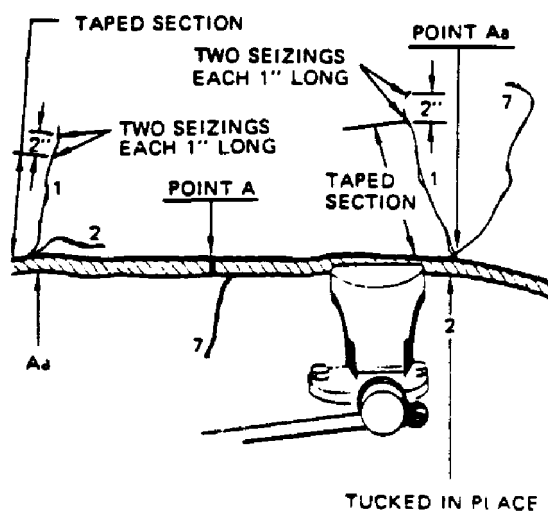

Figure 613-1-39. Vice Position

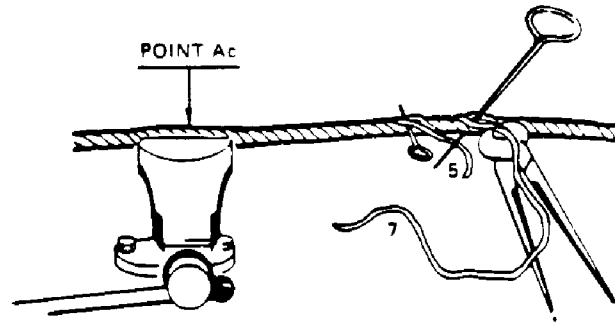

Figure 613-1-40. Finishing IWRC Splice

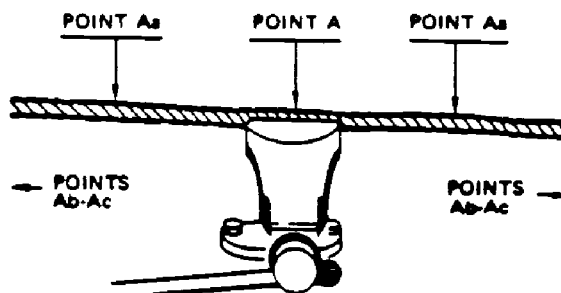

Figure 613-1-41. Finished IWRC Splice

613-1.11.7.7 Eye Splice. An eye splice is used to form a permanent eye in the end of six strand fiber core or IWRC rope. It may be used on regular or lang lay rope. The following procedure describes how the splice is made. The tools required are two mallets, a spike, seizing iron, knife, nippers, piece of pipe, and some fiber rope. This splice develops up to approximately 95 percent of the rope strength, but the efficiency decreases to 70 percent as the diameter of the rope increases. The only reason it will not carry up to the full breaking strength is that the wires nick each other under heavy stress where the strands cross inside the tuck and are weakened slightly. The weakest part of the splice is in the vicinity of the last set of tucks. For this reason it is very important not to hammer or distort this section more than is absolutely necessary.

613-1.11.7.8 Liverpool Splice. This splice is the easiest splice to make. Do not use it in a rope that is free to spin when loaded. The following describes the procedures to follow:

1. Measure back 3 feet from the end of the rope and place a temporary seizing to prevent unlaying further back than desired.
2. Unlay the strands back to the seizing; tape the ends of each strand. Form a loop for the desired size of eye and secure into a rigger screw.
3. Insert a spike into the rope against the lay. Insert under three strands and out the opposite side. Tuck the first strand under the three strands with the lay.
4. Tuck strand two through the same opening as the first strand but under two strands.
5. Tuck strand three into the same opening as the first two, except it goes under only one strand. Tucking the first three strands is shown in [Figure 613-1-42](#).

S9086-UU-STM-010/CH-613R3

6. Tuck strands four, five and six as shown in [Figure 613-1-43 \(A\)](#).
7. Tuck each strand as shown in [Figure 613-1-43 \(B\)](#) three additional times.
8. Work the strands into the splice ([Figure 613-1-44](#)) to prevent kinking the strands.
9. To decrease the possibility of the splice pulling out, tuck every other strand over two and under one.

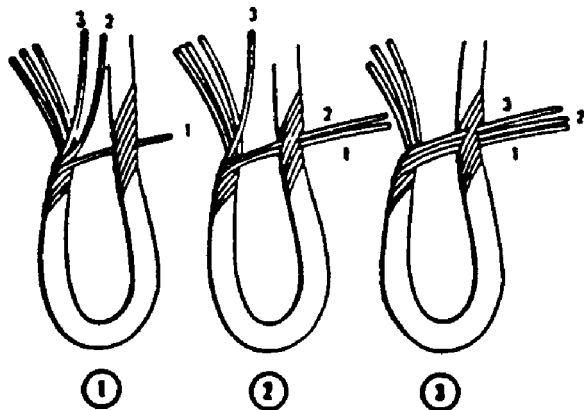

Figure 613-1-42. First Three Tucks of Liverpool Splice

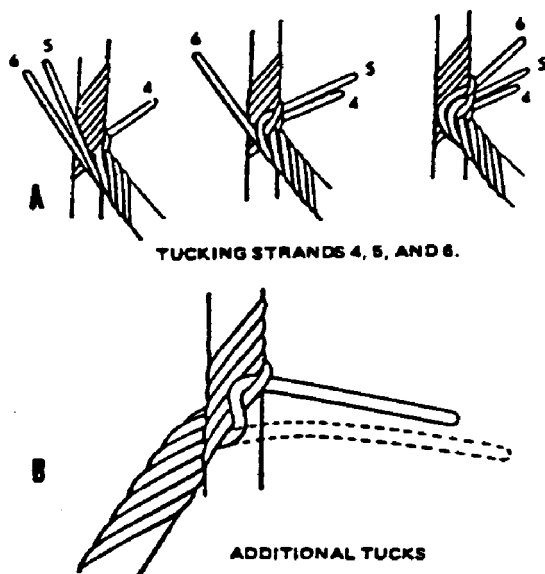

Figure 613-1-43. Strands Four, Five, and Six of Liverpool Splice

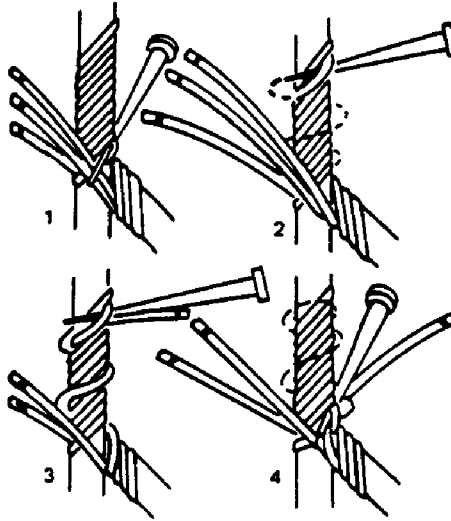
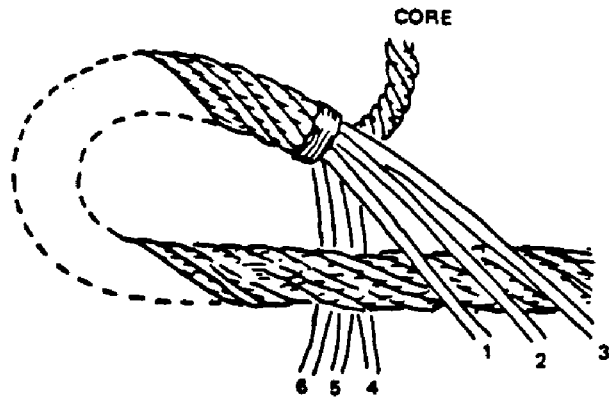

Figure 613-1-44. Working the Strands of Liverpool Splice

613-1.11.7.9 Lock-Tuck Splice. The lock-tuck splice is the preferred splice in that it will not pull or spin out. The following procedure used to make the splice described in steps 1 through 9 is shown in [Figure 613-1-45](#) and [Figure 613-1-46](#).

1. Prepare the rope as in paragraph [613-1.11.7.8](#) steps one and two, but increase the length of strands to be unlaid an additional 12 inches since five tucks are required.
2. Insert a spike into the rope under two strands and out. Take strand one through and under the two open strands, against the lay of the rope.
3. Strand two enters the rope through the same opening as strand one, but is tucked under three strands of rope against the lay.
4. Strand three enters the rope through the same opening as strands one and two, but differs in that it is tucked under two strands of rope with the lay.
5. Now tuck the core through the rope in the same path as strand two.
6. Proceed with the remaining three strands, tucking strand four through the rope at the same point as the previous three strands and core, under one strand of rope with the lay.
7. Proceed with the remaining three strands, tucking strand four through the rope at the same point as the previous three strands and core, under one strand of rope with the lay.
8. Tuck strand six under one strand with the lay to the left of where strand five entered the rope. Continue the remaining four tucks with strand six as shown in [Figure 613-1-45](#) (3).
9. Complete the splice by tucking the remaining strands and core with strand six.



1. BITTER END ON TOP OF STANDING PART.

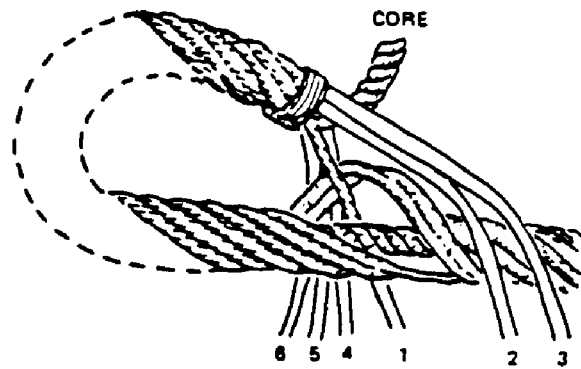

2. STRAND 1 GOES AGAINST THE LAY UNDER 2.

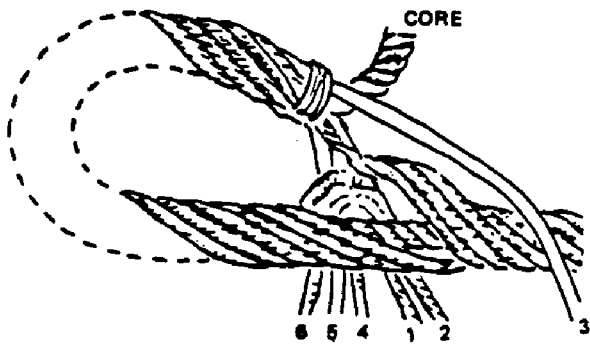

3. STRAND 2 GOES AGAINST THE LAY UNDER 3

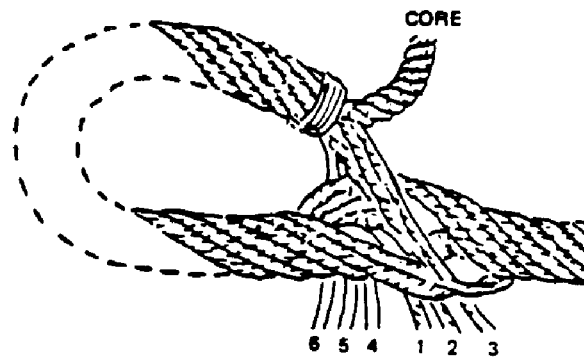

4. STRAND 3 GOES WITH THE LAY UNDER 2.

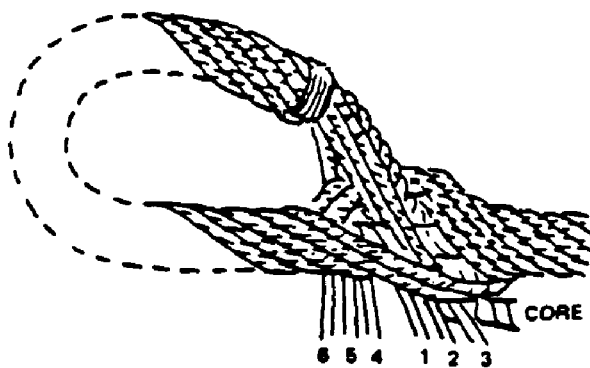

5. THE CORE FOLLOWS STRAND 2

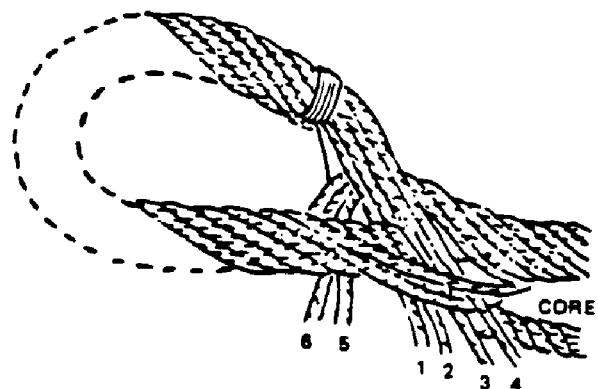

6. STRAND 4 GOES WITH THE LAY UNDER 1.

Figure 613-1-45. Lock-Tuck Splice

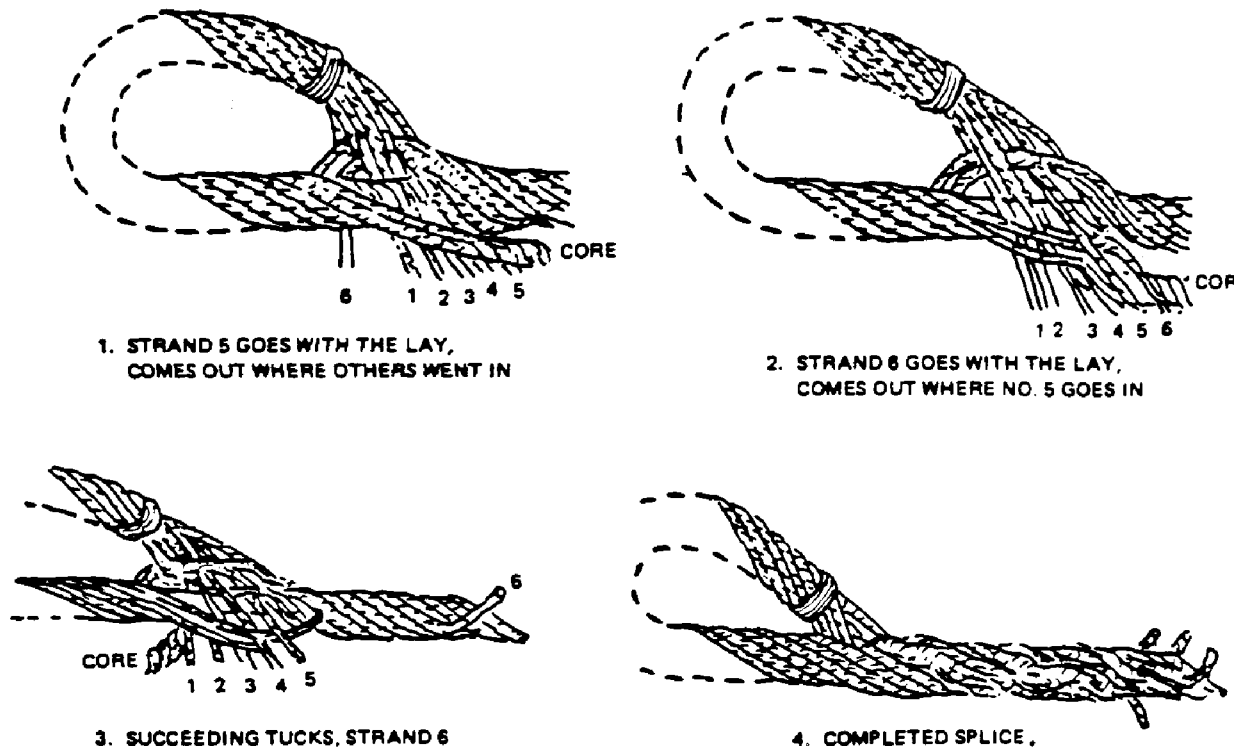

Figure 613-1-46. Lock-Tuck Splice Completed

613-1.11.7.10 Flemish Eye Splice (Molly Hogan). The Flemish eye splice (Molly Hogan) is an alternate method of forming a temporary soft eye in the end of a wire rope without permanent splicing. The eye is simple to form, requires a minimum amount of tools, and does not require use of a splicing vise. The breaking strength of a Flemish eye approaches 90 percent of the breaking strength of the rope. In choosing wire rope for this purpose, use rope with an even number of strands.

1. Form a Flemish eye by unlaying the rope strands 3 to 4 inches longer than twice the circumference of the eye size desired. See [Figure 613-1-47 \(A\)](#). The core can be cut out or layed in one section of the wire. A simple overhand knot is made, letting the strands lay together and adjusting the eye to the desired size. [Figure 613-1-47 \(B\)](#).
2. Bend sections of the strands through the eye so that the strands re-lay into position to form the rope. See [Figure 613-1-47 \(C\)](#). Continue until the eye is completed. See [Figure 613-1-47 \(D\)](#).
3. Secure the bitter ends of the strands to the rope with lashing, seizing, or a wire clip, to prevent unlaying of the rope. See [Figure 613-1-47 \(E\)](#). Pendants can be readily made to suit a given length with an eye on each end. [Figure 613-1-47 \(F\)](#).

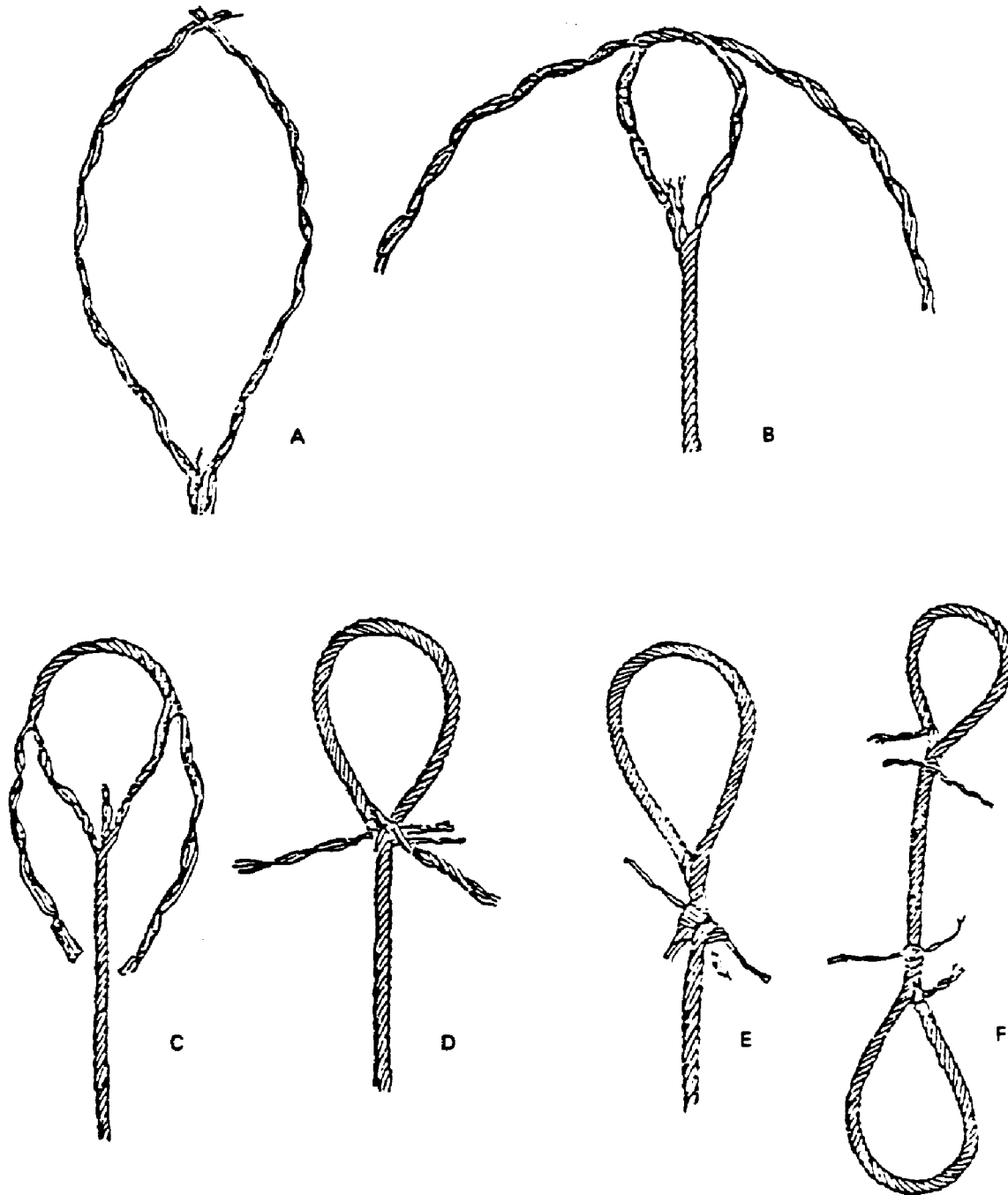

Figure 613-1-47. Flemish Eye Splice (Molly Hogan)

SECTION 2.

FIBER ROPE

613-2.1 INTRODUCTION

613-2.1.1 GENERAL. This section describes the content and construction of natural and synthetic fiber ropes and sets forth instructions for rope care, preservation, and use. Criteria for determining the serviceability of used ropes is also included.

613-2.1.2 COMPLEXITY. Fiber ropes are complicated, precision products that are adaptable to many uses under a variety of operating conditions. To meet the requirements which are imposed upon them, ropes are designed and manufactured using a number of different construction techniques and several types of fibers, either natural or synthetic. Large fiber ropes used by the Navy for working operation include those made of manila, nylon, polyester (Dacron), polypropylene, and aramid (Kevlar). Other small cordage used for seizing and lashing consists of sisal, cotton, jute, and hemp.

613-2.2 FIBER ROPE IDENTIFICATION.

613-2.2.1 FIBERS. Natural fiber ropes are readily distinguishable from the synthetics by their drier, harsher feel, and their shorter fiber length (24 to 36 inches). Synthetic fibers are usually continuous throughout the length of the rope. Nylon, polyester, multifilament polypropylene, and aramid fibers are very soft and fine, while monofilament and fibrillated film polypropylene fibers are coarse, stiff, and usually brightly colored.

613-2.2.2 LARGE ROPES. Large ropes are identified by a water-resistant marker inserted into the center of one strand of the rope. When untwisted and flattened, the marker indicates the manufacturer, the date of manufacture, and the fiber type. If these markers are not present, it is necessary to identify the rope fiber content before use (see paragraphs [613-2.2.3](#) and [613-2.2.4](#)).

613-2.2.3 MANILA AND SISAL ROPES. Sisal is used when the strength of manila is not required in 2-1/2 inch circumference and smaller ropes. To differentiate between manila and sisal, remove and observe a few fibers from a strand center. Manila fibers will be a light yellow to cream color, with occasional reddish brown tones, whereas sisal will be a lustrous white. If the condition of the rope makes color identification difficult, burn sample fibers on a metal surface. Manila ash will powder during burning, while sisal ash will retain the fiber form. When available, a known similar fiber should be used as a control.

613-2.2.4 SYNTHETIC ROPE. Polypropylene fibers will float in water because the specific gravity of polypropylene is less than the specific gravity of water which is 1.00. Nylon, polyester, and aramid fibers will sink in water because their specific gravities are greater than 1.00. Nylon and polyester are white; aramid is yellow. To differentiate between nylon and polyester, test burn a sample of the unidentified fiber. A slow-burning blue flame is indicative of nylon, and a fast-burning yellow flame indicates polyester. When available, a known similar fiber should be used as a control.

613-2.3 FIBER ROPE CONSTRUCTION

613-2.3.1 TWISTED FIBER ROPES. Twisted fiber ropes are constructed of natural or synthetic fibers that are twisted into yarns. In the case of synthetics, three yarns are plied together to prevent the fibers from untwisting.

These yarns are then grouped together to form strands, with the size and number of yarns in each strand varying according to the strand size required to make the particular rope size.

613-2.3.2 LARGE LAID ROPES. All Navy used fiber ropes 1-3/4 inch in circumference or larger are required to be right-laid ropes. This requirement averts hazards which would be encountered should a left-laid rope be attached to a right-laid rope. Under strain, ropes in a left-right combination would unlay each other, resulting in sudden rupture with a load far lighter than the normal maximum limit. Large fiber rope specifications are given in [Table 613-2-1](#).

Table 613-2-1. FIBER ROPE SPECIFICATIONS

TYPE OF ROPE	CIRCUMFERENCE (in)	SPECIFICATION
Aramid 4-Strand	3-3/8 to 8-3/16	CID A-A-50435
Polyester Double-Braided	3/4 to 16	MIL-R-24677
Polyester 12-Strand	1-1/8 to 15	MIL-R-24750
Polyester 8-Strand Plaited	3/4 to 16	MIL-R-24730
Polyester 3-Strand	5/8 to 12	MIL-R-30500
Polyester Double-Braided (Staple Wrap)	3/4 to 5	MIL-R-24536
Polyester Plaited (Staple Wrap)	3/4 to 4 -1/2	MIL-R-24537
Nylon Double-Braided	3/4 to 16	MIL-R-24050
Nylon 8-Strand Plaited	3/4 to 16	MIL-R-24337
Nylon 3-Strand	5/18 to 12	MIL-R-17343
Polypropylene 3-Strand	5/18 to 12	MIL-R-24049
Manila and Sisal	5/18 to 12	Fed Spec T-R-605

613-2.3.3 PLAIN-LAID ROPES. Plain-laid ropes are normally constructed of three strands twisted in an alternate pattern. Natural fiber ropes have a ZSZ twist pattern; the yarn has a right (Z) twist, the strand has a left (S) twist, and the rope has a right (Z) turn. Synthetic fiber ropes have a plied yarn construction with an SZSZ pattern; the single yarns have a left (S) twist, the ply a right (Z) twist, the strand a left (S) twist, and the rope a right (Z) lay. (See [Figure 613-2-1](#)). Four strand aramid fiber rope is constructed of parallel yarns in each strand, left laid helically around a strand core. The four parallel laid strands are twisted together in the opposite direction around a center core.

613-2.3.4 CABLE-LAID ROPES. Cable-laid ropes consist of three right plain-laid ropes twisted together in the opposite direction ([Figure 613-2-2](#)). The final turn in the cable-laid rope is always to the left.

613-2.3.5 PLAITED ROPES. Plaited ropes are available with synthetic fibers. The construction of the strands is similar to three strand synthetic plain-laid rope, except there are four right (Z) and four left (S) twist strands. These strands are plaited together in pairs, two parallel strands of left turn going to the right and two parallel strands of right turn going to the left (see [Figure 613-2-3](#)). These ropes are available in sizes from 3/4 inch to 16 inches in circumference and are spliceable by cross-braiding of the strands.

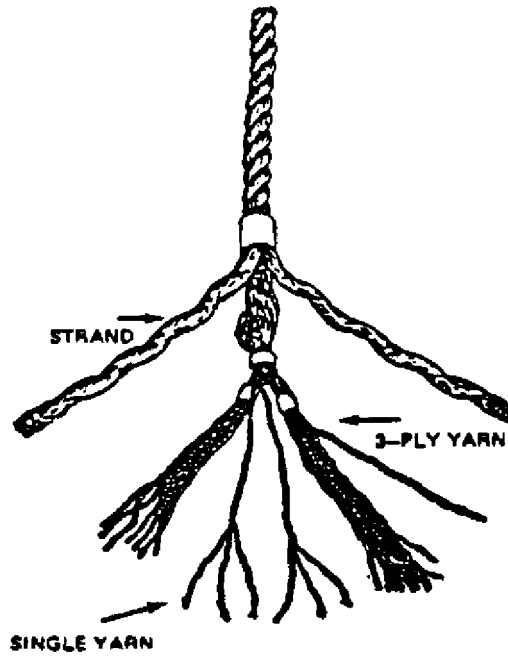

Figure 613-2-1. Synthetic Fiber Plain-Laid Rope

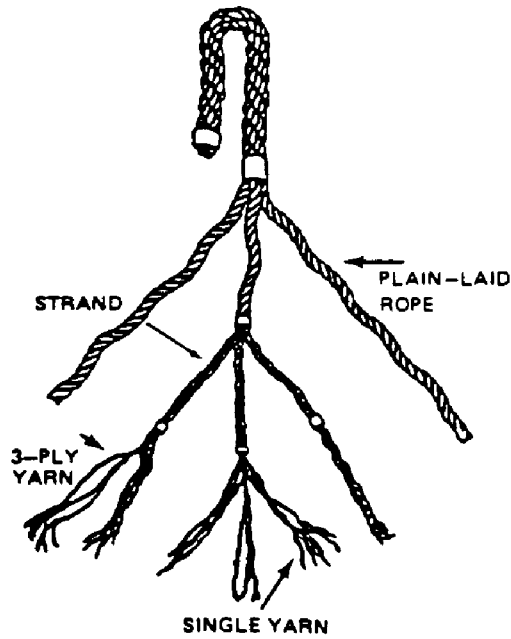

Figure 613-2-2. Synthetic Fiber Cable-Laid Rope

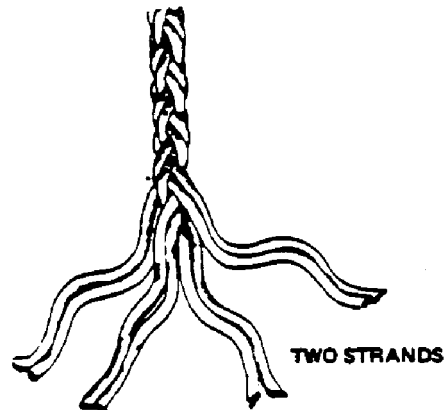

Figure 613-2-3. Plaited Rope

613-2.3.6 BRAIDED ROPES. Braided ropes have been reclassified from special to general purpose use. There are several different types of braided ropes: namely, hollow braid, stuffer braid, solid braid, and double braid. With the exception of double braid, braided ropes range in sizes up to 1-inch circumference. Double braided ropes are available up to 16 inches in circumference. The chief advantage of double braided rope is that it can be made in long continuous lengths (up to 20,000 ft) without noticeable splice bulge, and it will not kink or twist in a single part operation while under load.

613-2.3.7 DOUBLE BRAIDED ROPES. Double braided ropes are constructed of two hollow braid ropes with one rope located inside the other (Figure 613-2-4). The inner core rope is made of large single yarns having a slack, limp braid. The cover rope is made of larger single yarns having a tight braid to compress and hold the core. These ropes have a variety of uses, ranging from halyards to mooring lines. They range in size from 3/4 inch to 12 inches in circumference. Double braid is spliceable as described in paragraphs 613-2.5.5 and 613-2.5.12 with the use of special hollow fids shown in Figure 613-2-5.

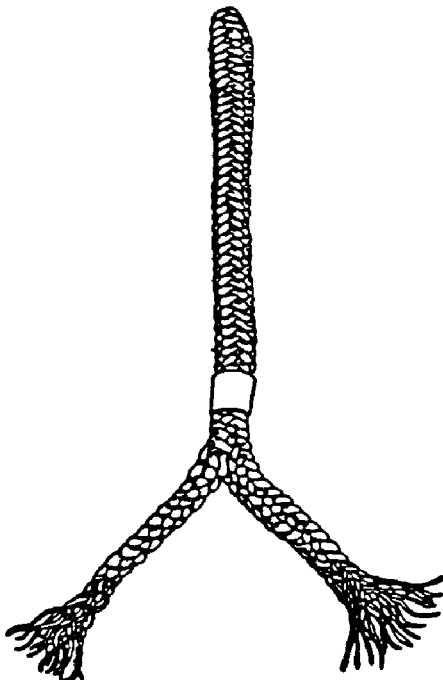

Figure 613-2-4. Synthetic Fiber Double Braided Rope

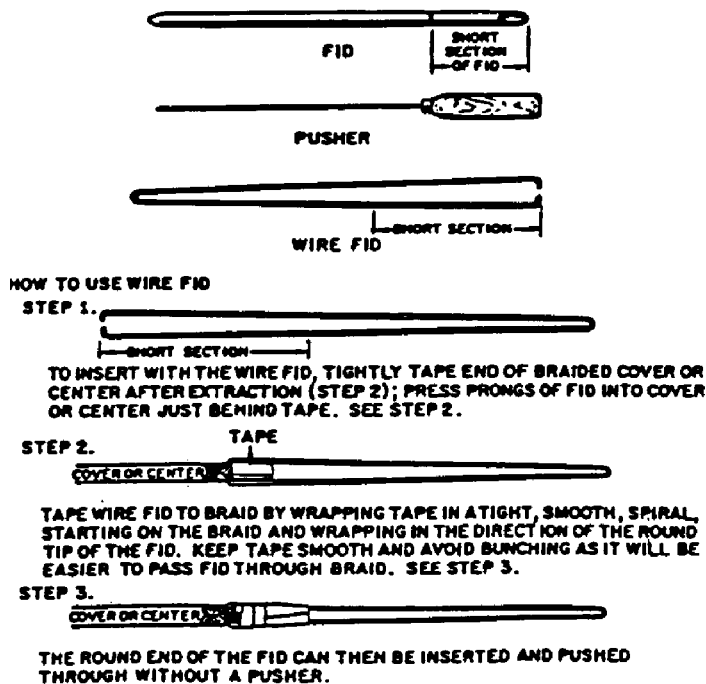

Figure 613-2-5. Fids Used for Splicing Double-Braided Line

613-2.3.8 SMALL CORDAGE ROPES. Small cordage ropes, or small stuff, are lines with a circumference less than 1-3/4 inches. Natural fiber lines, with the exception of cotton, are usually sized by the number of threads they contain and by circumferences, the largest being 21-thread. Other designations denote the specific use. For small cordage rope specifications, refer to [Table 613-2-2](#).

Table 613-2-2. SMALL CORDAGE SPECIFICATIONS

Type of Cordage	Specification
Cord, Cotton, General and Special Purpose, Sash and Venetian Blind	FED SPEC T-C-571
Twine, Hemp, Polished	FED SPEC T-R-650
Rope, Hemp, Tarred (Ratline, Seizing)	FED SPEC T-R-650
Yarn, Plied, Hemp, Tarred (Marline, Spun Yarn, Houseline, Roundline)	FED SPEC T-R-650
Cord, Fibrous (Lines, Lead)	MIL-L-1145
Halyard Signal Braided Treated	MIL-H-226

613-2.3.9 MARLINE. Marline is a two-ply, left-laid (ZS) line used for sennit, braided cord, or fabric-made flat-plaited yarns. When tarred, it is used for seizing, serving, and worming.

613-2.3.10 POLYETHYLENE ROPE. Polyethylene rope has a three strand twisted structure primarily designed for ring buoy lifelines where its lightweight and floating characteristics are distinct advantages. Polyethylene rope is obtained commercially.

613-2.3.11 SIGNAL HAYYARDS. Signal halyards are used for flying signal flags. Braided cotton halyards are no longer suitable for shipboard operations because of higher ship speeds, higher stack temperatures, and stack gases. However, where these conditions do not prevail, such as at land bases, cotton halyards are still usable. Plaited polyester rope (1-1/2 inch circumference) has been designated to replace nylon ropes for halyards according to NAVSEA dwg 804-5184208, Signal Halyards and Dressing Lines Arrangements. In the same drawing, plaited polyester is specified instead of nylon rope (plain laid and double braid) for dressing lines.

613-2.4 PRECAUTIONS AND TECHNIQUES FOR THE USES OF ROPES

613-2.4.1 GENERAL. Precautions and techniques for the safe use of natural and synthetic ropes are discussed in paragraphs [613-2.4.2](#) through [613-2.4.5.2](#).

613-2.4.2 UNCOILING AND UNREELING. Proper procedures for uncoiling and unreeling natural and synthetic rope are covered in paragraphs [613-2.4.2.1](#) through [613-2.4.2.3](#).

613-2.4.2.1 Uncoiling Natural Fiber-Laid Ropes. If natural fiber ropes are furnished in coils, uncoil them by drawing the rope up from the eye in a counterclockwise direction to avoid rope kinking. Should kinks develop as a result of improper uncoiling, DO NOT pull them out as they develop into permanent strand cockles and reduce the rope strength by 1/3. When kinks develop, lay the rope out straight and remove the unbalanced turn before use. Fake down ropes that are to be used in blocks and falls and allow them to relax for at least 24 hours before reeving. After reeving, tension the completed tackle under a load equal to 1/10 of the total strength of the number of parts making up the falls.

613-2.4.2.2 Uncoiling Synthetic Fiber-Laid Ropes. If synthetic fiber ropes are furnished in coils, uncoil them by rolling or by drawing from a turntable. DO NOT attempt to draw up through the eye or from the outer flakes of the coil. Should a coil of synthetic fiber rope collapse, causing kinking and tangling, DO NOT try to pull the rope free as it will form permanent cockles. The recommended practice is to secure one end of the rope and drop

the remainder of the coil into the sea (with no way on) where it will gradually uncoil as it relaxes without forming permanent kinks and cockles. This treatment will also remove bulges in and harden the structure of new soft-lay ropes.

613-2.4.2.3 Unreeling Synthetic Fiber Ropes. When synthetic fiber ropes are unreeled, it is recommended that a pipe mandrel be inserted through the center holes of the reel heads to hold the reel clear of the deck. The rope may then be drawn from the lower reel surface with no danger and without rope damage. DO NOT throw twisted synthetic fiber ropes off reel heads, as tangles and kinks will develop. It is also recommended that new, twisted synthetic fiber ropes be faked down on the deck and allowed to relax for 24 hours. Lengths of new twisted synthetic fiber ropes less than 50 feet long will relax within 1 hour when laid out straight. Fake down double braided rope in a figure-eight pattern. If double braided rope is faked down in the same fashion as described for twisted rope, it will develop twists.

613-2.4.2.4 Unwinding Aramid Lines. Care should be taken to properly unwind the rope from delivery reels onto the ship's hawser reels. Since new aramid line has similar construction to wire rope, it is installed on reels in the same manner as wire rope. Paragraph [613-1.9.1](#) identifies the proper procedure.

613-2.4.3 RECOILING AND REREELING. Recoil or Flemish all twisted ropes in the clockwise direction. Rereeling may be done in either direction, but take care that the turns are laid closely together to prevent binding in the underturns.

613-2.4.4 ELONGATION AND PERMANENT STRETCH. All ropes stretch under loads.

613-2.4.4.1 Natural Fiber Ropes. Load stretching is permanent and irreversible in natural fiber ropes such as manila and sisal. With each successive load increase, an additional amount of permanent stretch occurs until the stretch limit is reached and the rope fails. The stretch limit for a natural fiber rope is approximately 20 percent of its original length; for example, a 10-foot length of rope will break when its stretch limit is reached at 12 feet.

613-2.4.4.2 Synthetic Fiber Ropes. A portion of the load-stretch in synthetic fiber ropes is permanent and irreversible. However, this permanent stretch is small and is not progressive with successive loadings, provided that safe working limits are not exceeded. Under safe load conditions, the permanent stretch of nylon and polyester ropes is usually no greater than 7 percent of the original length; aramid is much less. After a synthetic fiber rope has reached its maximum stretch point (usually at the fifth loading), it will stretch and recover repeatedly without serious damage. The approximate stretch limits (at breaking strength) for synthetic fiber ropes vary widely: only 6 percent for aramid 4-strand; 30 percent for polyester double braid and polyester 12-strand; 35 percent for polyester 3-strand; 40 percent for nylon double braid; 45 percent for polyester 8-strand plaited and polypropylene 3-strand; 55 percent for nylon 3-strand; and 65 percent for nylon 8-strand plaited.

613-2.4.5 SHRINKAGE AND SWELLING Most natural and synthetic fiber ropes, when wetted, will shrink in length and swell in diameter to some extent. The shrinking and swelling do not seriously affect rope strength, but stiffness which occurs after drying out will cause some difficulty in splicing.

613-2.4.5.1 Natural Fiber Ropes. Wetting causes natural fiber ropes to shrink and swell. Shrinkage varies with rope size, ranging from 5 to 8 percent, with a corresponding amount of swelling and stiffening. After drying, natural fiber ropes remain in the shrunken state. Rope in this condition is not weakened, but does kink easily; therefore, the rope shall be roused out from lockers or coils with care.

613-2.4.5.2 Synthetic Fiber Ropes. Synthetic ropes shrink slightly when wetted, and minimal swelling may occur. The only noticeable effect of wetting is a slight increase in weight, with the exception of nylon which has approximately 15 percent strength loss from water being absorbed by the nylon molecules. (Nylon regains most of this strength loss if dried out.) Absorbed water will be squeezed out when the ropes are tensioned. Under working loads, the expelled water will appear as a steamlike water vapor. This vapor is beneficial because it cools the fibers when friction develops under repeated stretching conditions, as in towing.

613-2.5 PRECAUTIONS AND TECHNIQUES FOR THE USES OF ROPES

613-2.5.1 GENERAL. When properly installed, splices do not seriously affect rope strength. Eye, short, and long splice methods are explained in paragraphs 613-2.5.2 through 613-2.5.12. The eyes in mooring lines are normally 6 to 10 feet in length, depending on the size of the fittings (bitts, bollards or cleats) used. The rule of thumb for the preferred length of the eye is 5 times the diameter of the fitting. This prevents uneven loading of the eye.

613-2.5.2 EYE SPLICE IN PLAIN-LAID ROPE. The eye splice is made on plain-laid rope by unlaying a portion of the rope's strands and tucking these strands from right to left through the intact portion of the rope in a manner similar to weaving. Each free strand passes between the different rope strands to form the first series of tucks. Thereafter, each free strand passes over one rope strand and under the next rope strand as shown in Figure 613-2-6. This operation is repeated until three complete tucks are inserted into natural fiber ropes, or until four complete tucks are inserted into synthetic fiber ropes. For synthetic fiber ropes, maintain strand turns for the first two tucks. Thereafter, the strands may be unlaidd for the remaining two tucks. Complete the splice by adding two complete tucks to taper the splice. Tapering is accomplished by cutting approximately 1/3 of the fibers of each strand, tucking each strand over and under the rope strands, cutting approximately half of the remaining fibers of each strand, and completing the final tuck before cutting the remaining loose strands (i.e., approximately 2/3 and 1/3 of the fibers remain in the last two tucks). When splicing synthetic rope and whipping the strands and the rope, tape may be used instead of whipping, since whipping tends to slip on the smooth synthetic fibers.

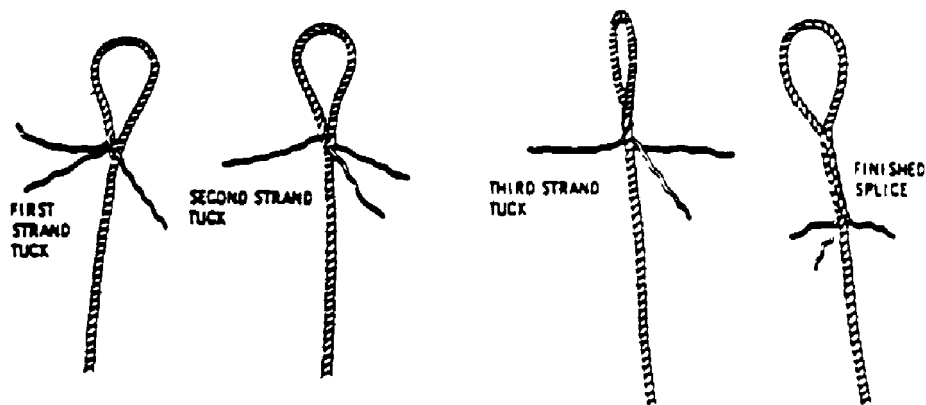

Figure 613-2-6. Eye Splice in Plain-Laid Rope

613-2.5.2.1 Natural Fiber Ropes. Natural fiber ropes can be eye spliced, using mechanical metal clamps (similar to those used for wire ropes), but the use of such clamps is discouraged as natural fiber ropes lose approximately 70 percent of their strength when spliced by this method. Do not splice synthetic fiber ropes with these clamps because these ropes will thin down and slide through the clamps under load. In addition, both natural and synthetic fiber ropes undergo significant reduction in strength when in contact with corroding metal parts such as clamps.

613-2.5.3 EYE SPLICE IN 4-STRAND ARAMID FIBER ROPE. The preferred method for making a sailmaker's eye splice for 4-strand rope is outlined in [Figure 613-2-7](#).

<p>GENERAL DESCRIPTION</p> <p>Eye splices consist of three main components: the eye, individual strands, and the standing part of the rope. The eyes in mooring lines are normally 6 to 10 feet long, depending on the size fittings (bollards, bits or cleats) used. The rule of thumb for the preferred length of the eye is 5 times the diameter of the fitting; this prevents uneven loading of the eye.</p> <p>PROCEDURE</p> <p>NOTE</p> <p>The eye requires chafing gear for abrasion protection.</p> <ol style="list-style-type: none"> 1. Measure a distance of 8 times the rope circumference from the end of the rope. Mark with a temporary whipping. Determine the eye size and form a loop which places the 1st whipping on the standing part at the end of the eye. Mark with a 2nd temporary whipping. 2. Unlay the strands of the rope to the 1st whipping and cut out the center core. Looking in the direction of the standing part, tuck the 1st strand under the top 2 strands of the standing part from left to right with the lay at the base of the 2nd whipping. 3. Tuck the 2nd strand under the next strand of the standing part with the lay. 4. Turn the rope over and tuck the 3rd strand under the next strand of the standing part with the lay. 5. Tuck the 4th strand under the next strand of the standing part with the lay. 6. This constitutes 1 full tuck. Ensure all working strands are pulled tight and free of twists. 7. Continue tucking all 4 strands in succession over and under the strands of the standing part for a total of 6 full tucks. 8. Taper an additional 2 tucks by cutting approximately 1/3 of the fibers for each tuck (i.e., 2/3 remain and 1/3 remain in last 2 tucks). 9. Using a light strain, set the splice. 10. (Optional) Marry the working strands using an inside whipping under the strands of the standing part at the last full tuck. 11. Cut the remaining tail off about 2 inches from where the strand exits the splice. If the strands are cut too close they can work loose or out, causing the splice to slip. 12. Whip the bottom of the splice with polyester whipping.
--

Figure 613-2-7. Sailmaker's Eye Splice for 4-Strand Rope (Preferred Method)

613-2.5.4 EYE SPLICE IN PLAITED ROPE. When a plaited rope is eye spliced, the eight strands are grouped in four pairs; two of the pairs turn to the left and two pairs turn to the right. The left-laid strands are unmarked and the right-laid strands are to be marked with a marking pen from the end of the rope through the distance to be worked in making the splice. Count back about 10 pics from the end (a pic is the distance from the topmost crown of one unmarked pair of strands to the next unmarked pair of strands) and tie a piece of twine securely around the rope so it passes directly over the center of both pairs of the marked strands. Unlay the strands several turns and tape the ends of each pair of strands together, taking care not to mix the strands. Unlay the rest of the rope back to the twine. The following procedure describes the making of an eye splice:

1. Form the size eye desired and place the marked strands on one side and unmarked strands on the other side of the standing part. Using a fid, open the rope; tuck the two pairs of marked strands under two successive unmarked strands as shown in view (A) of [Figure 613-2-8](#).

S9086-UU-STM-010/CH-613R3

2. Turn the eye over and tuck the two pairs of unmarked strands under the nearest marked strands as shown in view (B) of [Figure 613-2-8](#), completing the first round of tucks.
3. Take at least three more tucks with each pair of strands.
4. At this point, split the pair of strands. Select the strand of each pair that is nearest the eye, and cut off the strand flush where it emerges from the tuck as shown in view (C) of [Figure 613-2-8](#).
5. Splice the remaining single strands as before for two complete tucks, then cut off the ends as shown in view (D) of [Figure 613-2-8](#). The ends may be heated and fused, but take caution not to damage the rope.

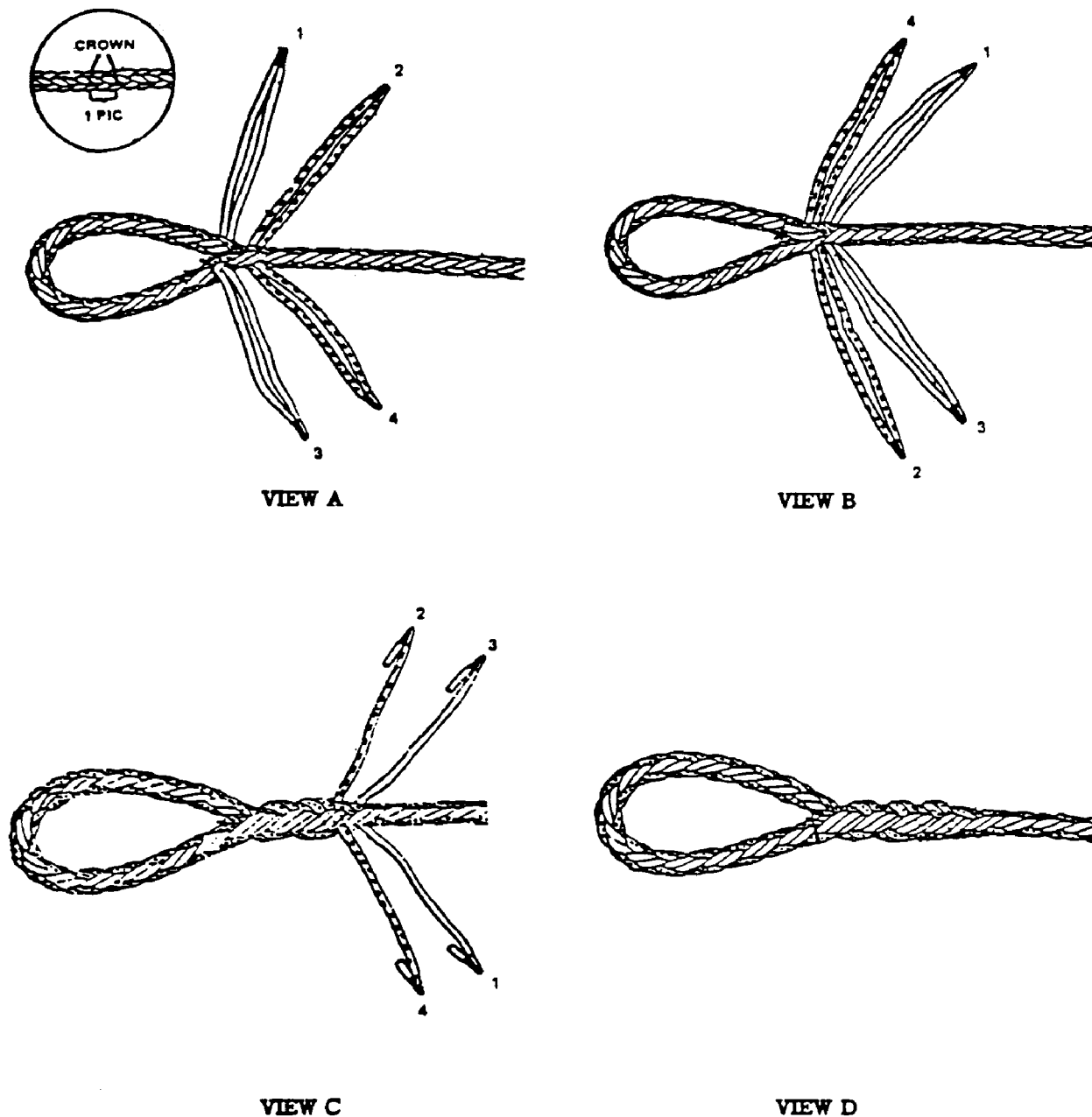

Figure 613-2-8. Eye Splice in Plaited Rope

613-2.5.5 EYE SPLICE IN DOUBLE BRAIDED ROPE. When a double braided rope is eye spliced, separate the cover and extract the core or inner braid from the cover by use of a pusher resembling a blunt ice pick (Figure 613-2-9). This procedure produces two rope ends, and both shall be bound with tape. The hollow braided cover is then inserted into the open end of a hard fiber fid, a tool which resembles a tubular knitting needle. The fid, with cover, is then inserted into and pushed through the hollow core from one premeasured point to another (Figure 613-2-10). The operation is repeated, threading the core end into the cover by use of the fid and the pusher (Figure 613-2-11). Adjustments are now made to bury the exposed section of the core (Figure 613-2-12). A view of the completed eye splice is given in Figure 613-2-12. Full details are outlined in NAVEDTRA 10101, **Boatswain's Mate, Volume 1**.

613-2.5.6 SHORT SPLICE. Short splices are used to join two plain-laid ropes or two plaited ropes end-to-end (see Figure 613-2-13). Short splices cannot be used with double braided ropes.

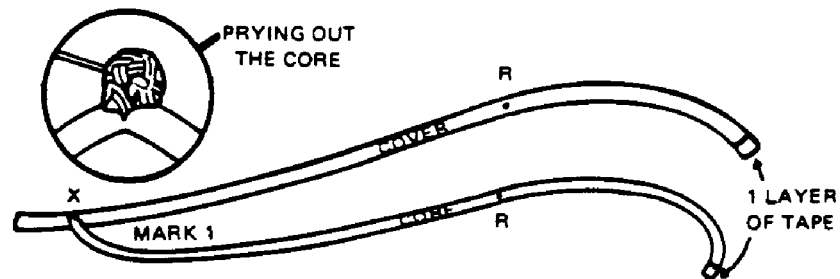

Figure 613-2-9. Extracting the Core from Double-Braided Rope

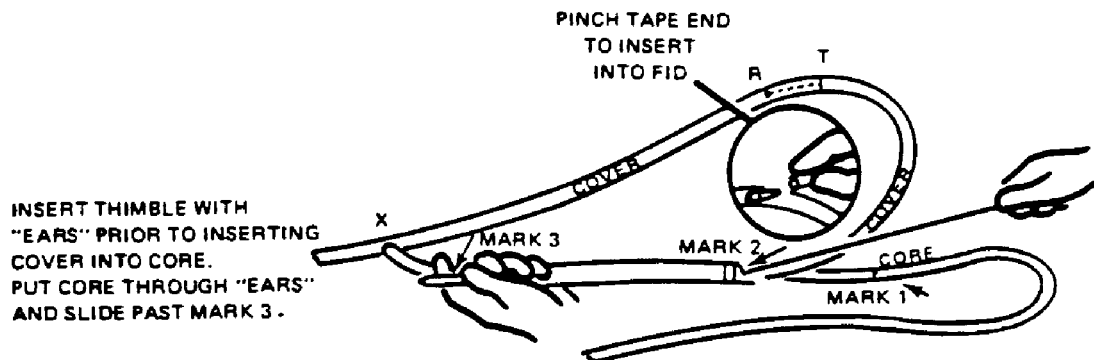

Figure 613-2-10. Putting Cover Inside Core of Double-Braided Rope

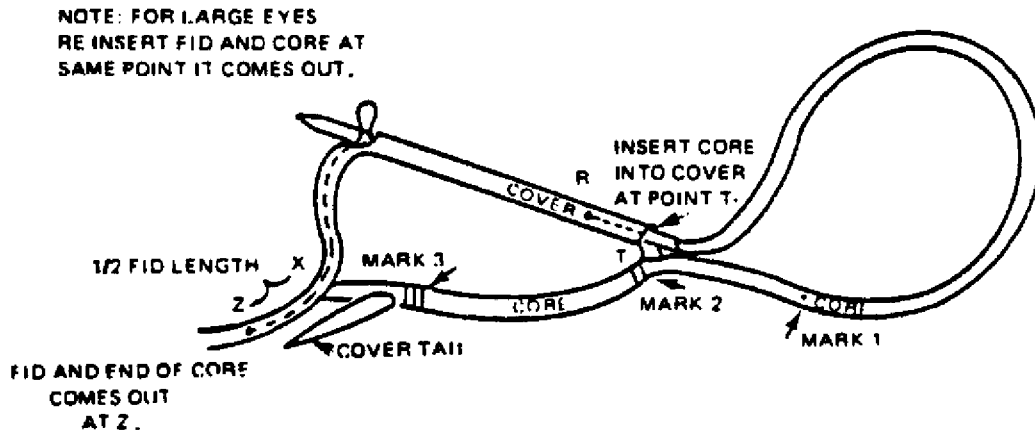

Figure 613-2-11. Reinserting Core Into Cover of Double-Braided Rope

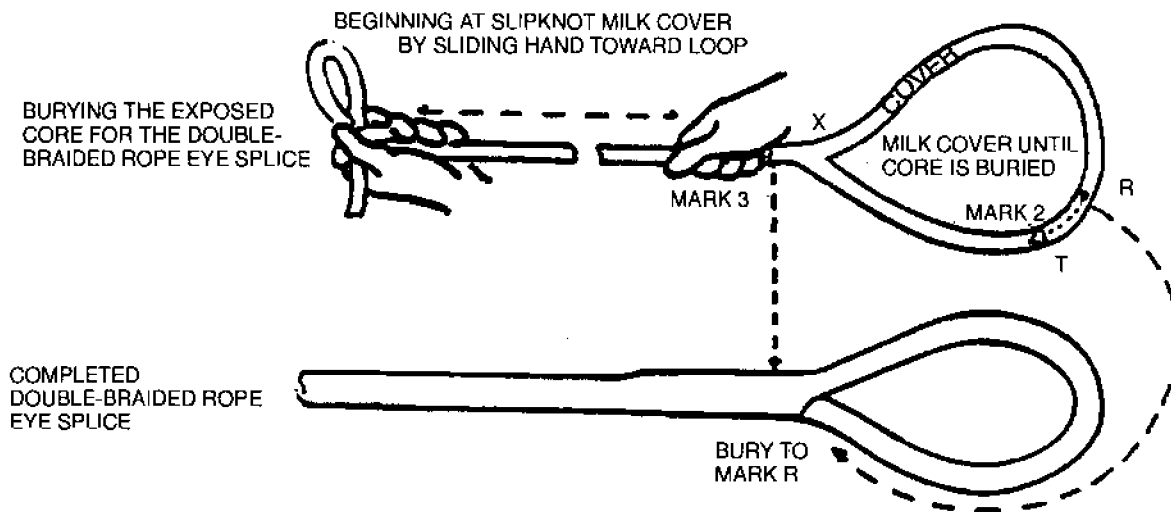

Figure 613-2-12. Double-Braided Rope Eye Splice

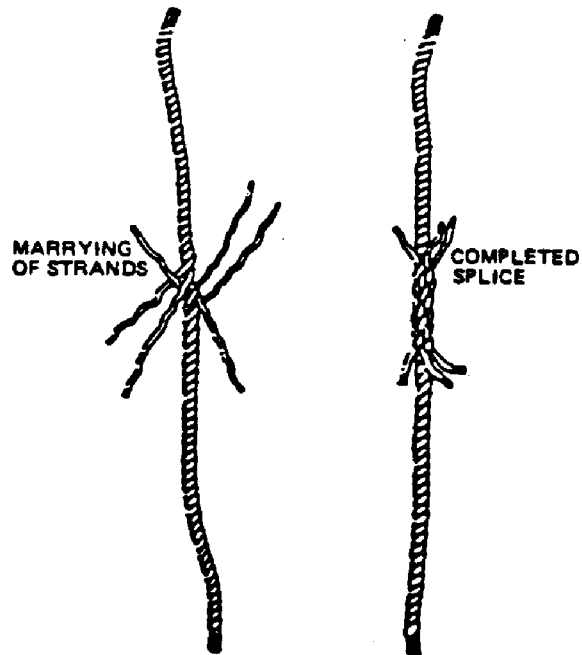
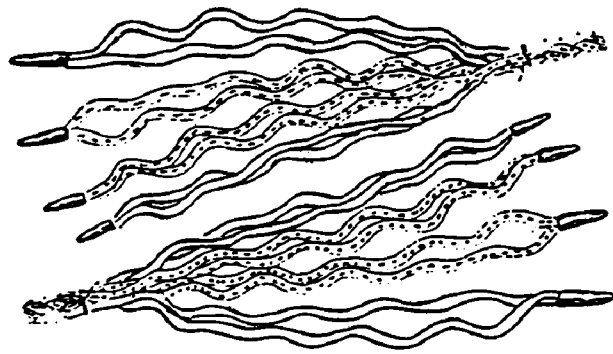

Figure 613-2-13. Short Splice of Plain-Laid Rope

6. Continue splicing for three additional complete tucks in each direction as shown in view (D) of [Figure 613-2-14](#).
7. Split the pairs. Using only one strand from each pair, make two additional rounds of tucks in each rope as shown in view (E). Complete splice by cutting the remaining strands off flush as shown in view (F) of [Figure 613-2-14](#).

S9086-UU-STM-010/CH-613R3



VIEW A

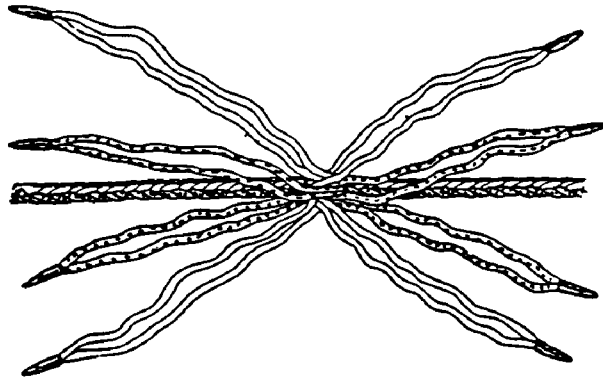

VIEW B

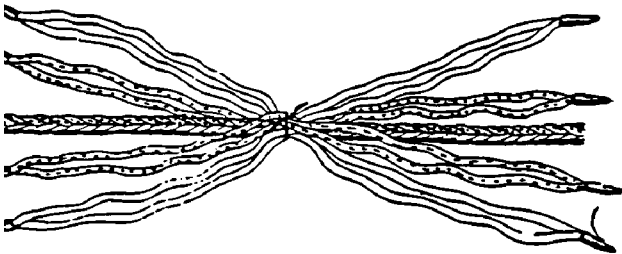

VIEW C

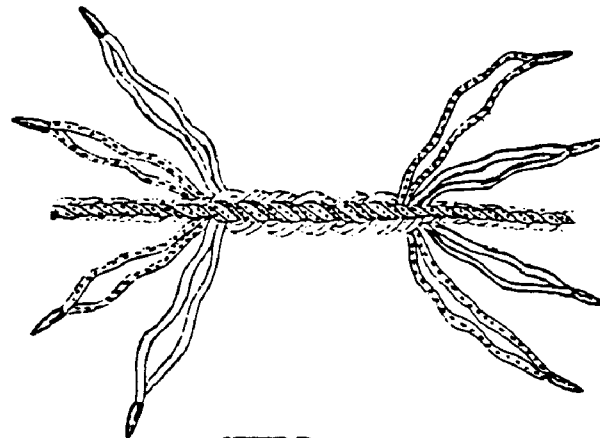

VIEW D

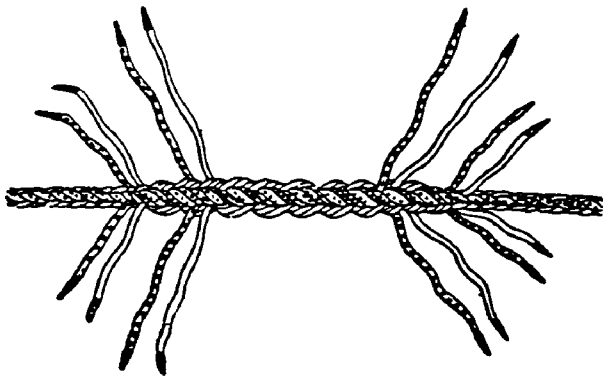

VIEW E



VIEW F

Figure 613-2-14. Short Splice of Plaited Rope (8 Strand)

613-2.5.9 LONG SPLICE. A long splice (end-to-end) is used to join two ropes whenever it is required that the spliced section be only slightly larger in diameter than the remainder of the rope, in order to pass through blocks or fairleads.

613-2.5.10 LONG SPLICE OF PLAIN-LAID ROPES. The long splice is made by unlaying two strands of each plain-laid rope and re-laying a strand of one rope end into the space opened by the strand of the other rope

end for a distance of approximately 12 times the rope circumference. This procedure is repeated with the remaining end strands until the two rope pieces appear as one length, except for the protruding strand ends. These ends are then split in half, tucked under the adjoining whole strands, and trimmed flush with the rope surface as shown in [Figure 613-2-15](#). Long splices are not recommended for plain-laid synthetic fiber ropes as they will pull out under repeated loadings. The long splice may be employed on cable-laid hawsers, but the turn in the component rope shall be retained during splicing. In extreme heavy load application, such as towing, take an additional backtuck with each strand.

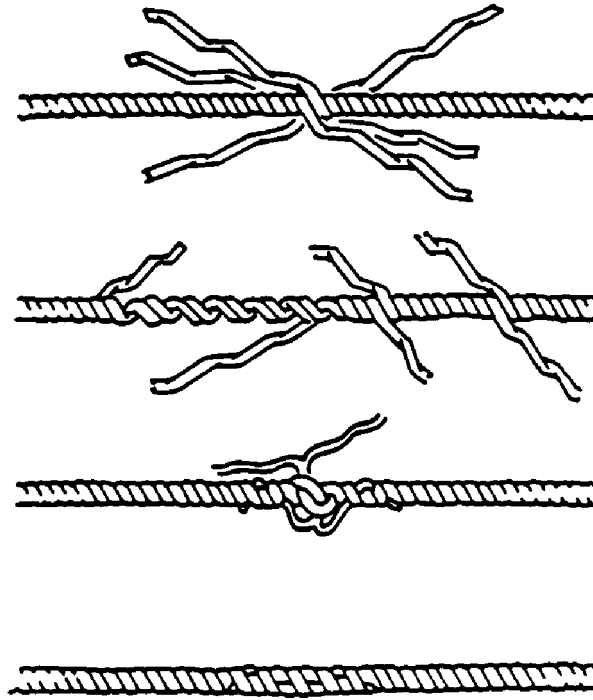

Figure 613-2-15. Long Splice of Plain-Laid Rope

613-2.5.11 LONG SPLICE OF PLAITED ROPE. Long splicing plaited rope is similar to long splicing twisted rope in that the strands from one rope are laid in place of the strands from the other rope. Procedures for splicing are as follows:

1. Lay the two rope ends side-by-side and mark the right-laid pairs of strands of each rope for a distance of 30 pics.
2. Lay each rope so that a pair of marked strands runs along the top. Starting from the ends, count back to the 9th pic (or crown). Mark this point clearly all around the ropes. Repeat this for three counts of six each and clearly mark. This will be the 3/4, 1/2, 1/4 and center marks as shown in [Figure 613-2-16](#).
3. At the center mark of end A, tie a piece of twine around the rope over the crown of the marked strands. With end B, tie the twine between the center mark of the marked strands and the next pair of strands so that the twine passes over the crown of the unmarked strands (see [Figure 613-2-18](#)).
4. Unlay the strands a short distance and tape them as explained for the eye splice. (See paragraph [613-2.5.4](#)) Unlay the remainder of the ropes back to twine and position the strands as shown in view (A) of [Figure 613-2-17](#).
5. Marry the bottom marked strands by passing the pair from the left between the pair on the right. Next, marry

S9086-UU-STM-010/CH-613R3

the pair of unmarked strands on the side away from you from right through the strands on the left. Repeat these steps for the remaining pairs of strands as shown in view (B) of Figure 613-2-17.

6. Cut and remove the twine at both centers. Taking four pairs of strands in each hand, pull the strands until the center marks coincide. Tie each of the four marriages individually, as shown in view (C) of Figure 613-2-17, to keep the strands from loosening.
7. Start splicing with the two top marked pair of strands, working from left to right. First cut off the outside pair coming from the right as shown in view (A), Figure 613-2-18. Cut the twine and pull the cut ends from under first unmarked pair of strands (view B). Insert the uncut marked pair of strands coming from the left in place of those withdrawn. Now and throughout the remainder of the splicing operation, make certain that the inserted strands are laid in parallel and not twisted over each other. Continue removing the cut pair one tuck at a time and immediately inserting the opposite pair, until the pair reaches the $\frac{3}{4}$ mark on the strands being inserted.
8. Having reached the $\frac{3}{4}$ mark, cut the tape holding the working pair and split them, and drop one strand at this point. Choose the working strand and retape the end. Withdraw the strand directly opposite from under the two unmarked strands, and tuck the working strand into its place. Continue this process for a distance of 6 more pics (view C), Figure 613-2-18.

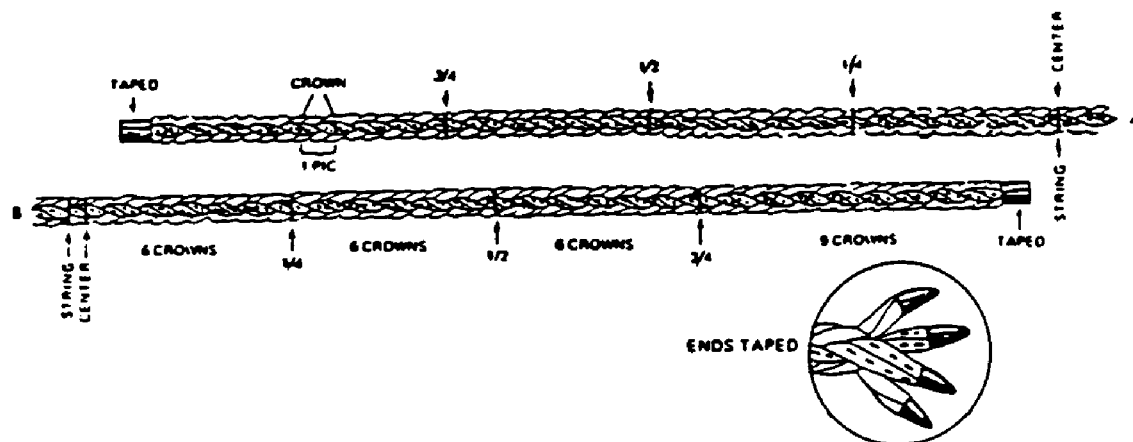
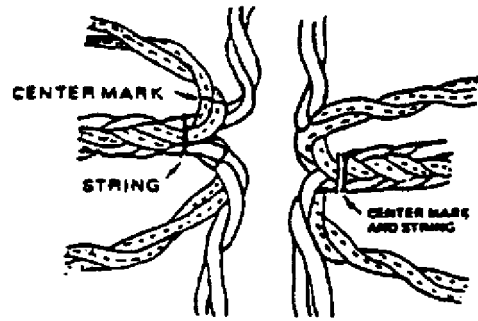
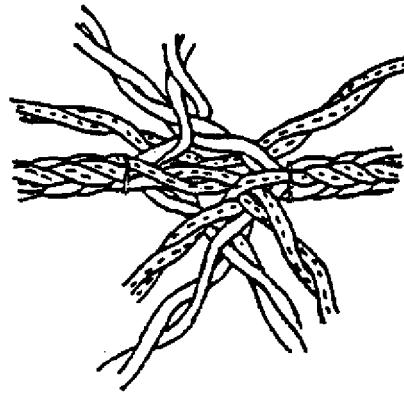

Figure 613-2-16. Preparing Plaited Rope for Long Splice



VIEW A



VIEW B

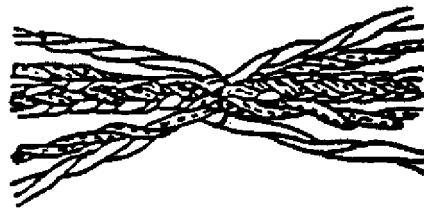

VIEW C

Figure 613-2-17. Marrying Plaited Rope Strands for Long Splice

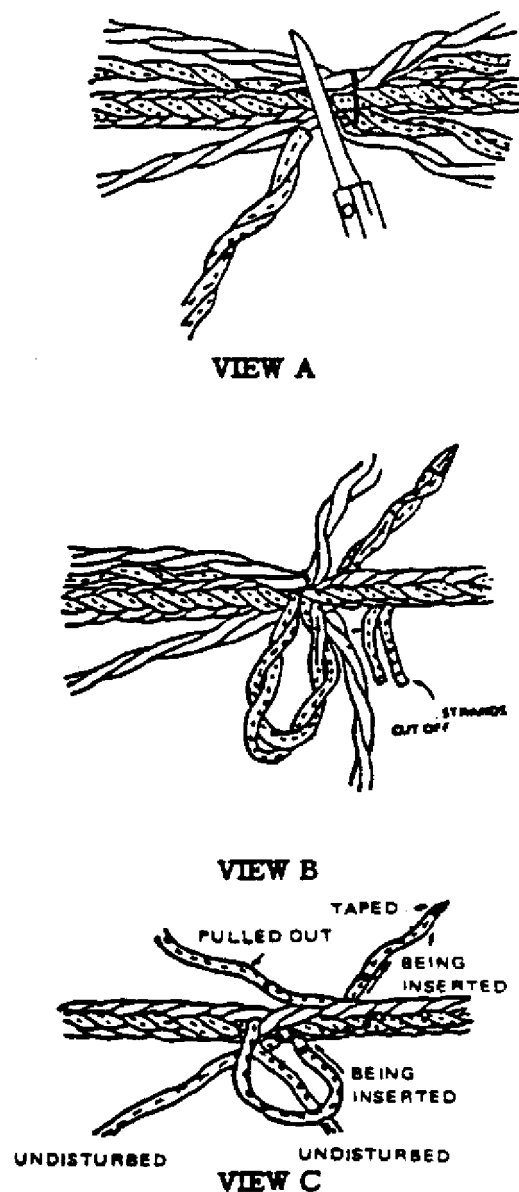

Figure 613-2-18. Tucking Plaited Rope Strands for Long Splice

9. Next, tuck the pair of unmarked strands opposite you, working from right to left. Cut the twine securing the marriage, and cut pair of strands (outer) coming from the left. Pull out the cut strands and tuck the other pair, as described in steps 7 and 8.
10. Repeat the procedure in steps 7 and 8 with the remaining unmarked strands. Work to the right with the pair of strands coming from the left until reaching the 1/4 mark. At this point, split the pair and continue tucking with a single strand until reaching the 1/2 mark.
11. Follow step 10 with the remaining marked strands, but work to the left with the strands coming from the right. Your splice now should look like that in view (A), [Figure 613-19](#).
12. Now, cut off the ends of the strands, leaving them at least 4 pics long. Taper and tape the ends. Work these

ends into the center of the line for a distance of 3 pics, each strand in the direction in which it was tucked (view B). Cut off flush the lengths of strands remaining after this step, making the finished splice as shown in view (C), [Figure 613-2-19](#).

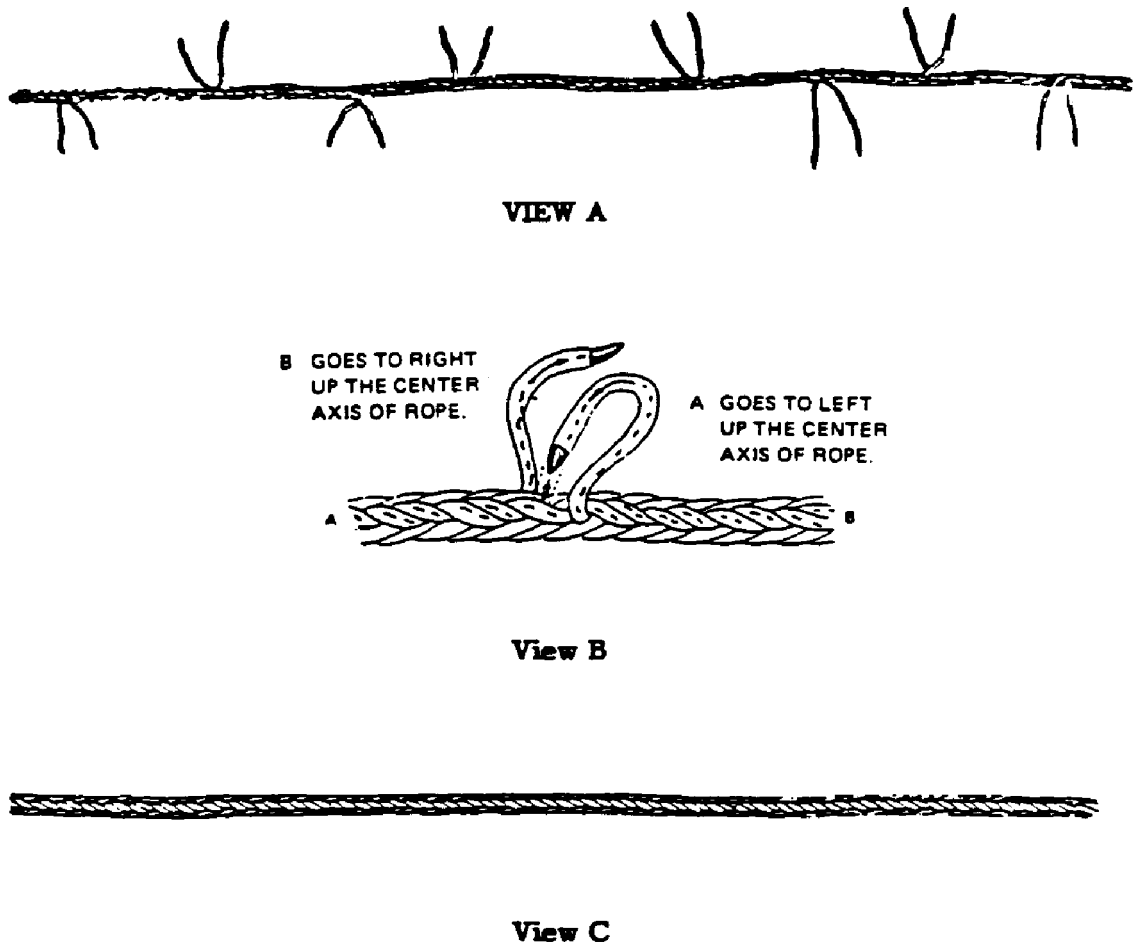

Figure 613-2-19. Completing Plaited Rope Long Splice

613-2.5.12 LONG SPLICE OF DOUBLE-BRAIDED ROPE. To long splice a double-brained rope, the braided core is extracted from each of the double-braided lines that are to be spliced ([Figure 613-2-20](#)). The hollow cover end of one line is then inserted into, through, and out of a hollow core section of the other line ([Figure 613-2-21](#)). The core of each line is then inserted into, through, and out of a cover section of the other line ([Figure 613-2-22](#)). The exposed core ends are buried by smoothing each cover toward the crossover until the exposed cores and crossover disappear into the cover ([Figure 613-2-23](#)), until all slack has been removed from the cover ([Figure 613-2-24](#)). Full details are outlined in **NAVEDTRA 10101 Chapter 2**.

613-2.5.13 THROAT SEIZING. Throat seizing is a method of making an eye that can be removed without damage to the rope. It is often used for standing rigging such as stays and braces, which shall be pulled up periodically to take up slack. The eye is made and held under tension while the seizing, usually two, are applied. An example of throat seizing is shown in [Figure 613-2-25](#).

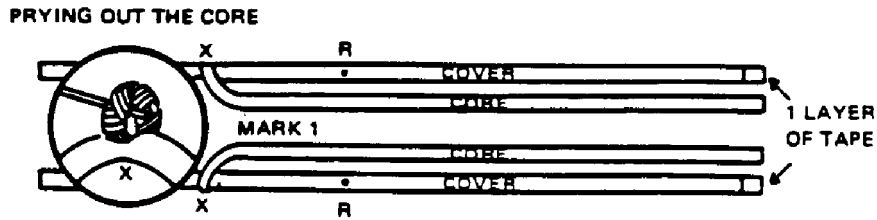

Figure 613-2-20. Extracting Cores from Double Braided Rope, Long Splice

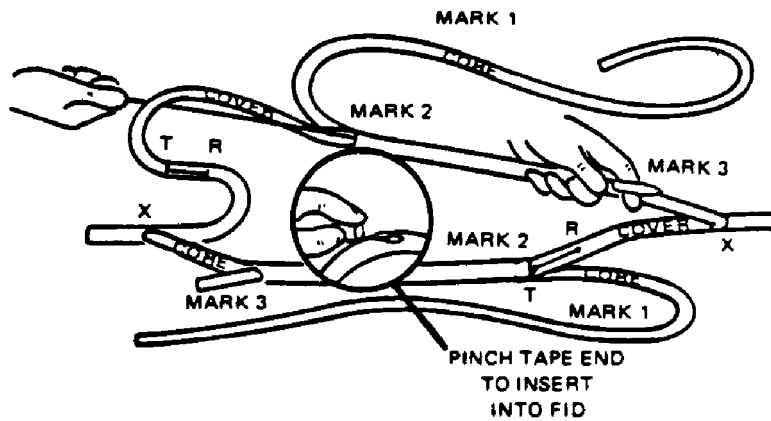

Figure 613-2-21. Putting Covers Inside Cores of Double Braided Rope, Long Splice

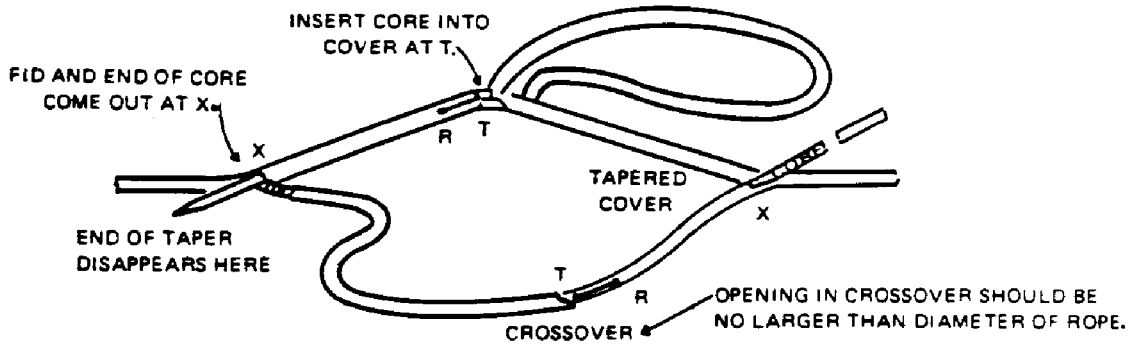

Figure 613-2-22. Reinserting Core Into Covers of Double Braided Rope, Long Splice

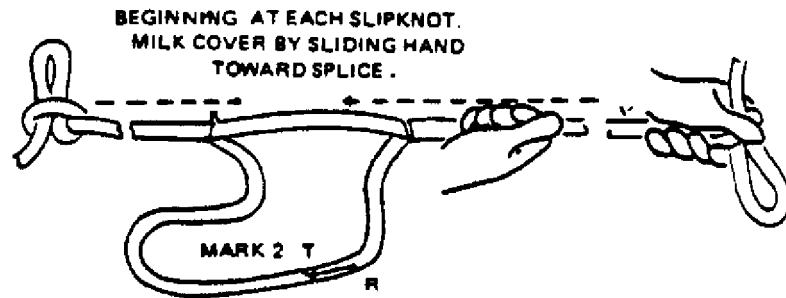

Figure 613-2-23. Burying the Exposed Cores of Double Braided Rope, Long Splice

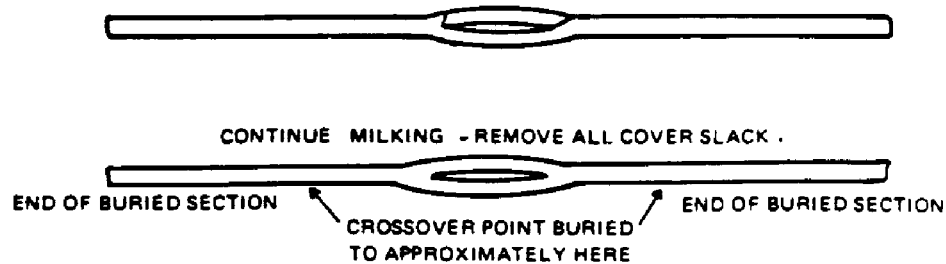

Figure 613-2-24. Completing the Double Braided Rope, Long Splice

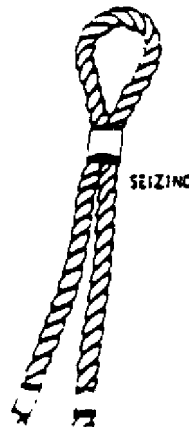

Figure 613-2-25. Throat Seizing

613-2.6 WHIPPING AND SEALING

613-2.6.1 WHIPPING. Whipping natural fiber rope ends is similar to seizing, but is done to prevent rope ends from fraying and unlaying.

613-2.6.2 SEALING. Heat-sealing the ends of synthetic rope is especially effective and will prevent sewed whippings from slipping off. This procedure consists of placing whipping around the rope, cutting off excess yarns, and then sealing the rope ends by pressing them against a hot metal surface or by applying heat from a torch.

S9086-UU-STM-010/CH-613R3

613-2.7 EFFECTS OF SECURING ROPES

613-2.7.2 GENERAL. Because ropes are commonly secured by the use of knots, round turns, figure eights, and riding turns, it is imperative that consideration be given to their influence on rope strength.

613-2.7.2 KNOTS. Knots, also known as bends, can reduce usable rope strength by 50 percent. They are not recommended for use if sudden or heavy loads may be applied. However, they are appropriate for lashing and securing light, steady loads.

613-2.7.3 ROUND TURNS. Rope strength is best preserved on H-bitts by use of round turns ([Figure 613-2-26](#)). When round turns are properly used with no half hitch, the rope will retain 90 percent of its strength. When half hitches are applied for snubbing the load, effective rope strength is reduced by 40 percent because half hitches (just as knots) cause shearing of the rope.

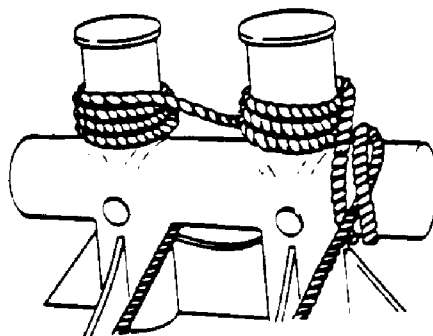

Figure 613-2-26. Correct Method of Securing on H-Bitts with Round Turns

613-2.7.4 FIGURE-EIGHT BENDS. Figure-eight bends on cleats or H-bitts reduce the effective rope strength by 50 percent, as do knots. When employed on double bitts, figure eights reduce the rope strength by only 25 percent. Figure-eights can cause problems especially when used on synthetic fiber ropes. With these ropes, the figure-eight bends lock up under heavy strains and, when the rope thins, the figure-eight bends slip suddenly. The rope then surges so rapidly that it often rides over the bitt tops.

613-2.7.5 OVERRIDING TURNS. Turns which overlay round turns on capstans, bitts, and winches, act as brakes to prevent rope surging. These turns allow effective control during easing-out operations ([Figure 613-2-27](#)) and have no adverse effect on rope strength.

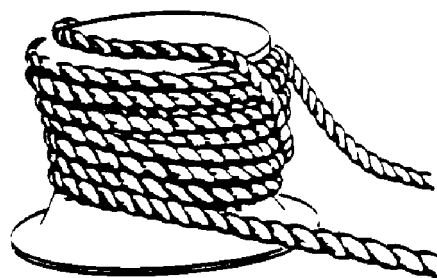

Figure 613-2-27. Overriding Turns on a Capstan

613-2.8 EXTENDING ROPE'S SERVICE LIFE

613-2.8.1 GENERAL. The safety of personnel and equipment and the performance of many important shipboard functions depend upon correct use and maintenance of ropes. All personnel are held responsible for protecting ropes from damage and for a thorough knowledge of the effects of age and working conditions on rope selection and performance.

613-2.8.2 DAMAGING CONDITIONS. Conditions that could cause mechanical damage to ropes are discussed in paragraphs [613-2.8.2.1](#) through [613-2.8.2.11](#).

613-2.8.2.1 Excessive Pull. To avoid excessive tension (overloading of the rope), knowledge of the recommended working load, the minimum breaking strength, and the elongation (stretch) is required. The minimum breaking strengths for plain-laid and braided ropes are given in [Table 613-2-3](#). The load should be applied slowly and carefully using a tattle-tale (refer to paragraph [613-2.13.3](#)) while noting the reduction in circumference and increase in length to avoid excessive tension. Tattle-tales cannot be used with aramid lines, because aramid lines have low stretch (comparable to wire rope); also, they do not neck-down (reduce circumference) appreciably when put under load. Load should be carefully controlled to avoid excessive tension (overloading of the line). This is best accomplished by having linehandlers check the line frequently until they have the feel of it. (Checking means allowing only enough line to render around the bitts to prevent the line from parting.) It is never prudent seamanship to hold a line while a ship has movement. Remember, a parted line serves no useful purpose and it is definitely a safety hazard.

Table 613-2-3. STRANDED AND BRAIDED ROPE MINIMUM BREAKING STRENGTH (LBS)

Size (in)	Minimum Breaking Strength (By Rope Material and Construction)											
	3-Strand Manila	3-Strand Poly-Propylene	3-Strand Polyester	3-Strand Nylon	4-Strand Aramid	Double Braided Nylon	Double Braided Polyester	Double Braided Polyester (Staple Wrap)	12-Strand Polyester	8-Strand Plaited Nylon	8-Strand Plaited Polyester	Plaited Polyester (Staple Wrap)
5/8	405	720	800	950	—	—	—	—	—	—	—	—
3/4	540	1,130	1,200	1,500	—	1,785	1,900	1,700	—	1,500	2,000	2,080
1	900	1,710	2,000	2,600	—	2,835	2,935	2,600	—	2,500	3,100	2,980
1-1/8	1,215	2,440	2,800	3,300	—	4,095	4,245	3,600	4,240	3,700	4,500	3,970
1-1/4	1,575	3,160	3,800	4,800	—	—	—	4,700	—	—	—	5,050
1-5/16	—	—	—	—	—	5,355	5,730	—	5,680	5,000	6,000	—
1-1/2	2,385	3,780	5,000	5,800	—	7,245	7,500	6,000	7,440	6,400	7,700	6,400
1-3/4	3,105	4,600	6,500	7,600	—	9,450	9,450	7,900	9,280	8,000	9,700	8,100
2	3,960	5,600	8,000	9,800	—	12,600	11,660	10,000	11,520	11,000	12,100	9,900
2-1/4	4,860	7,650	10,000	13,200	—	15,750	16,610	12,200	16,640	17,000	15,200	12,200
2-1/2	5,850	8,900	13,000	15,300	—	19,320	19,580	14,700	—	20,000	18,800	14,500
2-3/4	6,930	10,400	15,000	19,000	—	23,625	22,660	17,400	19,440	24,000	21,800	16,700
3	8,100	12,600	18,500	23,200	—	27,825	29,480	20,000	25,600	31,000	26,700	19,000
3-1/4	9,450	—	—	—	—	—	—	23,400	—	—	—	22,000
3-3/8	—	—	—	—	50,800	—	—	—	—	—	—	—
3-1/2	10,800	16,500	25,000	32,000	60,000	37,800	37,290	26,700	32,800	38,000	35,900	25,000
3-3/4	12,150	18,900	—	36,500	70,000	44,100	45,870	30,000	37,600	46,000	40,200	27,500
4	13,500	21,200	31,000	41,300	—	50,400	50,600	33,700	43,200	53,000	45,500	30,700
4-1/8	—	—	—	—	96,000	—	—	—	—	—	—	—
4-1/2	16,650	26,800	—	50,000	—	64,200	61,000	45,000	54,400	63,000	56,900	37,000
4-3/4	—	—	—	—	135,000	—	—	—	—	—	—	—
5	20,250	32,400	48,000	60,000	—	78,110	74,000	50,000	67,200	73,000	69,500	—
5-3/8	—	—	—	—	180,000	—	—	—	—	—	—	—

Table 613-2-3 STRANDED AND BRAIDED ROPE MINIMUM BREAKING STRENGTH (LBS) (CONT'D)

Size (in)	Minimum Breaking Strength (By Rope Material and Construction)											
	3-Strand Manila	3-Strand Poly-Propylene	3-Strand Polyester	3-Strand Nylon	4-Strand Aramid	Double Braided Nylon	Double Braided Polyester	Double Braided Polyester (Staple Wrap)	12-Strand Polyester	8-Strand Plaited Nylon	8-Strand Plaited Polyester	Plaited Polyester (Staple Wrap)
5-1/2	23,850	38,800	---	72,000	---	96,300	84,000	---	80,800	78,000	82,000	---
5-7/8	---	---	---	---	225,000	---	---	---	---	---	---	---
6	27,900	46,800	68,000	90,000	---	109,575	105,000	---	96,000	95,000	97,200	---
6-1/4	---	---	---	---	280,000	---	---	---	---	---	---	---
6-1/2	---	55,000	---	100,000	---	131,610	118,000	---	113,600	106,000	112,000	---
7	36,900	62,000	88,000	127,000	---	149,800	133,600	---	131,200	125,000	129,000	---
7-1/2	---	---	---	---	---	171,200	162,000	---	151,200	137,000	149,000	---
7-5/8	---	---	---	---	350,000	---	---	---	---	---	---	---
8	46,800	81,000	110,000	164,000	---	192,600	180,000	---	172,000	165,000	167,000	---
8-3/16	---	---	---	---	420,000	---	---	---	---	---	---	---
9	57,600	103,000	140,000	209,000	---	243,000	232,000	---	215,200	200,000	208,000	---
10	69,300	123,000	165,000	265,000	---	284,340	277,000	---	264,800	250,000	255,000	---
11	81,900	---	240,000	316,000	---	351,000	335,000	---	319,200	300,000	306,000	---
12	94,500	---	285,000	375,000	---	415,800	396,150	---	376,800	360,000	365,000	---
13	---	---	---	---	---	475,200	446,500	---	440,800	380,000	429,000	---
14	---	---	---	---	---	548,640	500,650	---	508,800	441,000	496,000	---
15	---	---	---	---	---	622,080	616,550	---	581,600	507,000	570,000	---
16	---	---	---	---	---	702,000	679,250	---	---	572,000	638,000	---

NOTES: 1) The Minimum Breaking Strength of Nylon, when wet, is reduced approximately 15 percent.
2) The Minimum Breaking Strength of manila, when mildew-resistant treated, is reduced approximately 10 percent (Sisal B/S = 0.89 x Manila B/S)

613-2.8.2.2 Surface Abrasion. Rope surface abrasion and chafing are serious concerns, particularly in regard to polypropylene and manila ropes, which have a high coefficient of friction with structural materials. Nylon and polyester ropes are less affected by abrasion and chafing, as is aramid rope, which has a braided cover on each strand, but each should be protected to assure longer service life.

613-2.8.2.3 Chafing Gear. Chafing gear, such as old firehoses and heavy canvas wrapping, can be used to protect ropes that stretch only short distances under working conditions. If ropes are worked in long runs, install wood, leather, or rubber rails over the rough surfaces so that the ropes will ride on a soft, smooth surface.

613-2.8.2.4 Deck Fittings. Keep bitt, cleat, and chock surfaces smooth to minimize fiber rope abrasion and prolong rope service life. A surface is sufficiently smooth if it is not abrasive when the back of the hand is rubbed vigorously against it.

613-2.8.2.5 Gritty Material. A variety of gritty materials, ranging from hard crystalline sands to flaky graphite, can seriously damage fiber rope when they become lodged between the rope yarns and strands while the rope is in a relaxed state. When loads are later applied to the ropes, the grit works progressively outward, cutting the inner fibers and destroying the rope structure. During sandblasting operations, hard crystalline grit will abrade the surface of taut manila ropes, but will have little effect on nylon and polyester ropes. The soft, waxy nature of polypropylene ropes allows grit to imbed easily into the strands even when the rope is under tension. The imbedded grit then cuts the fibers whenever the rope is under tension.

613-2.8.2.6 Effects of a Freezing Environment. Although not always recognized as such, frozen water (ice) is another abrasive that can cut fibers under tension. Wet natural and synthetic fiber ropes that are allowed to freeze are therefore reduced in strength. Although bending will cause the external ice coating to fall away, ice crystals that remain within the rope yarns and strands will fracture the inner fibers and result in rope failure when tension is applied to the rope. Allow frozen ropes to thaw thoroughly and drain before use. Store fiber ropes under cover to prevent ice crystal formation. However, nylon, polyester and aramid ropes should be wound tightly on reels and covered when dry.

613-2.8.2.7 Sharp Edges. To prevent rope damage, use padding or fairleads on sharp metal edges of parts such as coamings, fairwater guides, metal block cheeks, and padeyes, or, if practical, relocate or modify the parts.

613-2.8.2.8 Shearing. Another type of mechanical damage is the shearing action caused by crushing or pinching. Such damage often occurs when a kink in the rope is permitted to run into a block and bind against the cheeks. Other crushing effects are caused by knots in the rope or by heavy loads being hauled over the rope. Shearing can be readily avoided by careful attention to receiving and handling procedures.

613-2.8.2.9 Rope Kinks and Cockles. Premature rope failure (particularly in the case of new ropes) most frequently results from the use of force in removing kinks. The kinks develop into strand cockles if improperly handled. The proper method for removing kinks is to lay out the rope and rotate the end counter to the direction of the kink. To avoid kinks, take care to properly unreel stranded rope (such as aramid 4-strand) from delivery reels and onto ship's hawser reels. Stranded rope should be taken off and put onto reels in the same manner as wire rope (paragraph [613-1.9.2](#)).

S9086-UU-STM-010/CH-613R3

613-2.8.2.10 Bending. Bending under load (as on blocks and tackles) causes internal abrasion between the twisted strands of the rope. This internal abrasion can be detected by the powdery appearance of the internal strands. Bending usually results from excessive loads, too small sheaves, or sheaves that do not rotate freely because of improper lubrication or bad bearings.

613-2.8.2.11 Drag. The drag over each lubricated sheave adds 10 percent to the load being moved. Rope speed is the primary factor in the development of internal stresses under bending conditions. In general, the larger the sheave, the longer the life of the rope. Blocks for use with synthetic ropes are to be in accordance with MIL-B-24220 or commercial equivalent. Do not exceed the SWL of the block.

613-2.9 EFFECT OF AGING ON FIBER ROPES

613-2.9.1 NATURAL FIBER ROPES. Natural rope fibers (manila and sisal) consist mainly of cellulose and have the same aging properties as paper. They become yellow or brownish and brittle with time, even under the best storage conditions. This color change indicates some loss of strength, usually from 1 to 2 percent loss per year of storage. However, strength loss alone is not a true index of rope deterioration because the rope fibers become so stiff and brittle with age that, when ropes are bent over sheaves or other holding devices, the fibers rupture easily and break down further with each successive bend, even under light loading conditions. Rope bending strength loss is more significant than rope breaking strength loss because the bending strength decreases five times more rapidly. Because of this, it is important that the age of unused natural fiber ropes be determined from the identification marker tape within the rope strand. Should the marker indicate the age to be 5 years or more, do not use the rope for critical operations or those involving the lives of personnel. Natural fiber ropes more than 5 years old (even though unused) shall be used only for lashing, fenders, or matting.

613-2.9.2 SYNTHETIC FIBER ROPES. Although synthetic fiber ropes also show color change with aging, this does not indicate a change in strength. White nylon ropes develop a lemon-yellow or pink color and become stiff when stored in a warm, humid area. At first the stiffness will present some handling difficulty, but when tensioned, white nylon ropes will become flexible with no breaking or bending strength loss. Colored nylon ropes, on the other hand, are not approved for outdoor marine applications because they will deteriorate rapidly when exposed to the elements (particularly sunlight). Polyester ropes lose very little strength due to exposure and tend to take on a gray cast. Unstabilized polyethylene and polypropylene ropes will deteriorate very rapidly when exposed to sunlight on a continuing basis and could easily lose 40 percent of their strength over a 3-month exposure period. The use of polyolefin ropes (polyethylene or polypropylene) should be avoided where prolonged exposure to sunlight is required.

613-2.10 ROPE REPLACEMENT AND USAGE

613-2.10.1 Always replace fiber rope with the one specified for the particular application; consult ship's rope list, COSAL, drawings, or Ship's Information Book. In making up tackles, or where no other guidance is provided, choose a rope that will provide a safety factor of 6 or more for noncritical lifts and 10 or more for critical lifts, based on the minimum breaking strength of the rope when new. Critical lifts are those performed at sea or under adverse weather conditions; involving or conducted over, ordnance; lifts overhead; and lifts warranting precision or extra care.

613-2.11 ROPE STOWAGE

613-2.11.1 GENERAL. Instructions for the care and preservation of fiber ropes in storage are covered in paragraphs [613-2.11.2](#) and [613-2.11.3](#).

613-2.11.2 NATURAL FIBER ROPE STOWAGE. Ropes of manila, sisal, and other natural fibers are subject to deterioration from heat, sunlight, and mildew rot. They are also damaged by chemicals, acids, alkalies, paints, soaps, and vegetable oils such as linseed or cottonseed. It is therefore mandatory that natural fiber ropes be stored away from any of these damaging materials or conditions. The best storage for natural fiber ropes is a dry, cool, dark, well-ventilated area, far removed from any source of chemicals or gaseous fumes. If natural fiber ropes are stowed on deck, hang them on reels or pegs (located under an overhang) and cover with weatherproof materials.

613-2.11.3 SYNTHETIC FIBER ROPE STOWAGE. Synthetic fiber ropes are usually packaged on reels and covered with waterproof paper to prevent damage in transit or storage. If covers or reels are damaged during prolonged storage, repair the reels and promptly replace the paper covering to prevent exposure, because most synthetic fiber ropes are affected by sunlight, fluorescent light, and chemicals. Nylon ropes are sensitive to all light radiations and acid chemicals; polyester ropes are sensitive to sunlight and caustic (alkaline) chemicals.

613-2.12 ROPE-USE PRECAUTIONS, INSTRUCTIONS, AND INSPECTIONS

613-2.12.1 GENERAL. Use rope-use precautions, instructions, and inspections given in paragraphs [613-2.12.2](#) through [613-2.14.10](#) when using or working with ropes.

613-2.12.2 PRACTICES TO AVOID. Avoid the following practices in the use of fiber ropes:

1. Observe all standard safety precautions for handling lines under tension.
2. Do not put strains on kinked lines with buckled strands, and do not pull the kink through a block. Coax strands back into place before use.
3. Do not drag lines on the decks (paragraph [613-2.8.2.5](#)) because of the effects of imbedded grit and surface abrasion.
4. Do not let rope wear become localized in one spot. Use chafing gear on the line, reverse the line end-for-end, or cut off the end so that wear is transferred to an unworn spot.
5. Do not let a weak or damaged section ruin the whole line. Cut the bad section out and splice the line back together, thereby retaining 95 percent of the rope's strength.
6. Do not let the lay of a line become unbalanced by continual winch use in the same direction. Reverse the turns periodically and keep the kinks out. To break in new ropes, bend right-laid line clockwise onto reels or capstans.
7. Do not use chain or wire stoppers; use fiber rope stoppers instead.
8. Do not let lines become fouled in machinery, gears, or other sharp metal equipment.
9. Surging lines unnecessarily on running capstans or winches shall be avoided as much as possible, because this action abrades and burns the fibers.
10. Do not put sudden strain on lines. Load and surge smoothly to avoid shock loads.
11. Do not let lines tighten when wet. Slack off wet lines and halyards.

S9086-UU-STM-010/CH-613R3

12. Do not permit sharp bends and metal edges to wear lines. Use chafing gear; lash well.
13. Do not use the small-size block for falls. As a general rule, blocks and sheaves shall be at least three times the circumference of the fall rope. Oversized sheaves are preferred to undersized sheaves.
14. Do not neglect blocks. Inspect and lubricate blocks frequently, and repair or replace them when necessary.
15. Do not lubricate lines. They are already properly lubricated, and over-lubrication can cause strength loss, capstan handling difficulty resulting from rope slippage, and loss of control.
16. Do not stow natural fiber ropes in wet or damp locations, nor if wet, against bare steel. Store ropes in cool, dry, dark, well-ventilated areas, preferably on racks, pegs, or pallets.
17. Do not mix lines of different materials or construction.

613-2.12.2.1 In normal tackle work, each sheave increases the load being moved by 10 percent. It is important that sheaves be in proper working condition so that this factor does not create an overload. For example, the 10 percent factor increases to 30 percent when a sheave cannot rotate. Should all four sheaves be bound, the safe working load of the rope will be exceeded and the rope is in danger of parting.

613-2.12.2.2 Use chafing gear on aramid lines, where lines pass through chocks and in the eye of the line. Ensure that bits, chocks, and bollards have a smooth finish to prevent chafing.

613-2.12.3 INSPECTING NATURAL FIBER ROPES FOR DAMAGE. When inspecting natural fiber ropes, look for indications of rope damage as follows:

1. When inspection reveals fiber rupture and powdering between strands, the rope has been overloaded and rendered unfit for service.
2. If dark red, brown, or black spots are noted between the strands or if a sour, musty, or acidic odor is detected, the rope has suffered considerable damage from rot and shall be destroyed. Storage of rotting rope adjacent to new rope will promote rapid infection of the new rope. Remove both ropes so stored; dry and air the area before restorage of the sound rope.
3. Cut out distorted strand areas because they reduce rope strength by as much as 60 percent. These defects are the result of improper coiling and bending operations and can be avoided by strictly observing approved rope coiling, bending, and unkinking procedures.
4. Internal wear is detected as a powdery appearance between the natural fiber rope strands and by a fuzzed or fused condition between synthetic rope strands.
5. Frequently examine ropes in service in areas where chemicals (acids or alkalies) are used for evidence of chemical damage such as brittle or ruptured fibers, dark red or brown spots, salt incrustation, and swollen areas. Remove from service any rope showing signs of such damage.
6. Inspect ropes used in tackle operations for localized rust spots; pay particular attention to ropes used in exterior marine applications where iron rusting promotes rope deterioration. For example, 6 days of contact with rusting iron in a salty, wet atmosphere can reduce natural fiber rope strength by as much as 1/3, and 30 days of such contact can totally destroy the rope.
7. Do not use natural fiber ropes of indeterminate age in any critical application. Natural fiber ropes over 5 years old, however, shall not be considered safe under any circumstances. Rope age can be determined from the rope identification tape which records the rope type and the manufacture year.
8. A harsh, dry, dead feel in manila or sisal rope indicates doubtful quality and shall preclude rope use.

9. Hand-pull tests of single or small rope fiber bundles can indicate the quality of the rope from which they were removed. A strong fiber will usually cut into the flesh, leaving a red mark, and will emit a sharp crackling noise upon breaking. Weakened fiber will not mark the flesh and will break with a soft popping sound.
10. Accumulation of heavy, greasy materials adversely affects rope strength and reduces holding power on bitts or cleats. Remove greasy materials by rinsing with light petroleum fuels such as diesel oil or kerosene.
11. Accumulation of heavy, greasy materials adversely affects rope strength and reduces holding power on bitts or cleats. Remove greasy materials by rinsing with light petroleum fuels such as diesel oil or kerosene.
12. Measure ropes that are to be end-for-ended for sheave fit to ensure that the unworked end has not swollen to the point that it will chafe on the block cheeks. If the end does not fit into the sheave, cut away the swollen section before reeving.
13. When 30 percent of the yarns in a rope cross-section have been worn through, remove the rope from working operations. Worn ropes may be used for lashing, fenders, or matting.

613-2.12.4 SYNTHETIC ROPES. Factors to consider when using synthetic fiber ropes, along with general information pertaining to naval use, are discussed in paragraphs [613-2.12.4.1](#) through [613-2.14.10](#).

613-2.12.4.1 Advantages of Synthetic Ropes. Numerous laboratory and service tests have determined that, size for size, synthetic fiber ropes are 1-1/2 to over 4 times as strong as manila ropes of equal size. Their superior strength and durability, with good working elongations (except for aramid), make these ropes very desirable for many applications involving surging or impact loads. Synthetic rope resistance to rot and mildew contributes to longer rope life. Reduced bulk and weight are other advantages offered by synthetic fiber ropes. The increasing use of synthetic ropes makes it essential that all rope handling personnel be familiar with the properties of this type rope, since these properties differ from those of manila rope. Particular attention should be paid to the precautions for using synthetic fiber ropes (see paragraph [613-2.14](#)).

613-2.12.4.2 Specifications. Synthetic fiber ropes are available from Defense Industrial Supply Center and may be procured according to Military Specifications or Commercial Item Descriptions (see [Table 613-2-1](#) and [Table 613-2-2](#)).

613-2.12.4.3 Maintenance. Synthetic fiber ropes soon fluff or nap as a result of small surface filament abrasion. The strength loss is negligible, except in the case of monofilament polypropylene ropes which behave in the same manner as natural fiber ropes. In fact, most synthetic ropes will hold a load despite extensive yarn abrasion. If a localized, badly chafed section develops, this section shall be cut out and the ends spliced together for satisfactory continued use. Surface abrasion and stretching are not necessarily indicative of reduced rope load-carrying ability, because synthetics have little internal abrasion and little permanent stretch.

1. Ropes that have become slippery (from an accumulation of oil or greasy materials) shall be scrubbed down with liquid soap and water or with a light oil such as diesel oil or kerosene.
2. Rusting can cause a 40 percent loss of nylon rope breaking strength in only 1 month. Accordingly, avoid prolonged rope contact with rust-prone bare iron surfaces unless such surfaces have protective rust-proof coatings, such as anti-corrosive epoxy or silicone alkyd or latex-base paints. Wood, aluminum, and bronze surfaces have no effect on synthetic fiber ropes.

S9086-UU-STM-010/CH-613R3

613-2.13 SYNTHETIC ROPE; GENERAL USAGE

613-2.13.1 GENERAL. Instructions specifically applicable to synthetic rope usage are covered in paragraphs [613-2.13.2](#) through [613-2.14.10](#).

613-2.13.2 HEAVY LOADS. Polypropylene ropes are used on an equal size basis with manila ropes. A nylon or polyester rope of smaller circumference may be substituted for manila rope. For heavy load applications, a nylon or polyester rope has approximately half the circumference of the equivalent manila rope. Aramid rope would be even less. Consult with

Carderock Division

Naval Surface Warfare Center

Philadelphia, PA, Code 9712

for the recommended type and size of synthetic rope selection.

- a. If the stretch of a synthetic fiber rope is excessive for the control required, the line may be doubled-up by passing the bight, and thereby halving the elongation.
- b. Heavy strain will wring out steam-like water vapor from wet synthetic fiber hawsers. This is not only normal (under safe working loads) but also beneficial, because it cools the fibers and minimizes wear.

613-2.13.3 SYNTHETIC ROPE STRETCH. Synthetic fiber rope that has not exceeded its safe working load, can withstand repeated stretching with no serious effect. Under normal working loads synthetic rope stretches and decreases in diameter (elastic elongation), but recovers to its normal size when unloaded.

613-2.13.3.1 Tattle-tales. To ensure against overloading, a tattle-tale line (6 thread manila) is attached from the two measured points on the used (after permanent elongation set) working rope, [Figure 613-2-28](#). The rope when tensioned to its safe working load will stretch a certain percentage of its elastic elongation, depending on the type of synthetic fiber and construction. When this point is reached, the tattle-tale will become taut (see [Figure 613-2-29](#)), warning that there is a danger of exceeding the rope's safe working load. The type of synthetic rope, length of tattle-tales, and distance between suspension points is shown in [Table 613-2-3](#).

WARNING

Tattle-tales cannot be used on aramid fiber ropes, due to their low stretch. The load should be carefully controlled on aramid lines to avoid excessive tension of the line. This is best accomplished by having linehandlers "check the line" frequently until they have a feel for the load. Checking means allowing only enough line to render around the bits to prevent the line from parting. It is NEVER prudent seamanship to HOLD a line while a ship has movement. Remember, a parted line serves no useful purpose and is definitely a safety hazard.



Figure 613-2-28. Relaxed Synthetic Fiber Rope

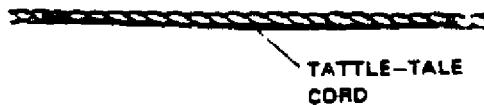

Figure 613-2-29. Synthetic Fiber Rope Maximum Workload

Table 613-2-4. DIMENSIONS FOR TATTLE-TALE LINES

Type of Synthetic Rope	Length of Tattle-Tale (Inches)	Distance Between Marks (Inches)
Nylon Three Strand	35-1/2	30
Nylon Plaited	43-1/2	40
Nylon Double-Braid	43-1/2	40
Polyester Three Strand	63-1/2	60
Polyester Plaited	62-1/2	60
Polyester Double-Braid	62	60

613-2.13.3.2 Aramid Line Failure Indicators. A safety feature of the aramid rope is, that it is designed to give line handlers an advanced warning of failure. One strand is designed to break before the other three, versus the four load bearing strands parting all at once. This sequential failure helps release the energy of the break gradually; it will take approximately 10-15 seconds for the next or the other three strands to break. Other advance failure indicator will be a loud "bang", and a cloud of smoke. Rope lengths of 50 feet are tested to ensure that these properties are present in aramid rope purchased by the US Navy. However, conformance to this requirement has not been demonstrated on rope lengths longer than 70 feet. **REGARDLESS** of the safety features of aramid lines, they **MUST** be treated with the same respect afforded to other lines under tension.

613-2.13.4 MOORING LINES. When ships are moored, the lines shall be taut at the shortest scope permitted by tides; in general, no further adjustment will be required, because the synthetic ropes will stretch and recover without significant damage. For surface ship mooring lines, the substitution of aramid rope for other synthetic ropes is shown in [Table 613-2-5](#). For all submarines, the preferred mooring line is double braided polyester (MIL-R-24677), because it provides the best combination of high strength, low stretch and abrasion resistance, and it need not be stowed on reels.

Table 613-2-5. SUBSTITUTION OF ARAMID ROPE FOR OTHER SYNTHETIC ROPES

Minimum Brk Str (lbs)	Aramid 4-Str (in/circ)	Nylon 3-Str (in/circ)	Nylon Plaited (in/circ)	Nylon Dbl Brd (in/circ)	Polyester Plaited (in/circ)	Polyester Dbl Brd (in/circ)	Polyester 123-Str (in/circ)
50,000	3-3/8	4-1/2	4	4	4	4	4
60,000	3-1/2	5	4-1/2	4-1/2	4-1/2	4-1/2	4-1/2
70,000	3-3/4	5-1/2	5	5	5	5	5
96,000	4-1/8	6	6	5-1/2	6	6	6
135,000	4-3/4	7	7-1/2	7	7	7	7
180,000	5-3/8	8	9	8	8	8	8
225,000	5-7/8	9	10	9	9	9	9
280,000	6-1/4	10	11	10	10	10	10
350,000	7-5/8	11	12	11	11	11	11
420,000	8-3/16	12	13	12	12	12	12

NOTE: Aramid line shall be substituted only where the existing rope stowage is on reel and shall not be substituted where non-rotational rope characteristics are required (e.g., in bin stowage of rope or in towing applications). Total allowance of ship mooring or tending lines shall be the same material and construction.

613-2.13.5 ELONGATION AND PAIRING OF DISSIMILAR ROPES. Where parallel sets of lines are used, as in mooring lines, never pair synthetic fiber ropes with a lower elongation material such as wire or manila. Do not pair nylon ropes with polyester or polypropylene or aramid ropes; similarly, do not pair synthetic ropes of different constructions.

613-2.13.6 SYNTHETIC ROPE STOPPERS. Use synthetic fiber rope stoppers for holding synthetic fiber ropes under load. Do not use manila, wire, or chain stoppers on any synthetic fiber ropes, because synthetics will cut through manila, and the chain or wire will cut through the synthetics. There are a variety of techniques utilizing stoppers with synthetic rope. The two most commonly used stoppers are the Crisscross and the Rat-Tail. The crisscross stopper is the preferred stopper for stopping off synthetic rope. Using a 3-inch circumference synthetic rope stopper for ropes up to 6-1/2 inches in circumference or a 5-inch circumference synthetic rope stopper for rope 7 inches through 12 inches in circumference, form a bight in the rope to be used by passing it around a bitt, cleat or through a padeye. Crisscross the two legs around the rope to be held at 180 degrees at least six times, then twist the ends together and hold. The rat-tail stopper may be used but under heavy loads it will jam.

613-2.13.7 COILING. Constantly coiling plain-laid synthetic rope in the same direction tends to unbalance the lay. To alleviate this condition, such rope occasionally should be coiled down against the lay. Double braided and plaited ropes should not be coiled down but faked down or laid out in figure-eights.

613-2.13.8 REDUCING ABRASION AND MINIMIZING SURGING. Bitts, chocks, and other holding devices shall have smooth surfaces to reduce abrasion and minimize line surging under working conditions. Use chafing gear where sharp metal edges could cause damage. In reeling or heaving-in operations, take care that connecting devices do not chafe or cut the rope. Do not use manila, wire, or spring-lay rope with synthetic rope on the same chocks, bitts, or reels; synthetic ropes will cut through the manila, and the wire ropes will cut through synthetics.

613-2.13.9 CAPSTANS. When synthetic ropes are used on capstans for heavy or impact loading, fill the capstan with round turns and add at least two more turns; the last turns shall overlay the previous ones. This reduces the hazard of sudden surges when rendering out.

613-2.13.10 TOWING END FITTINGS. Do not use regular thimbles for use with towing hawser because regular type thimbles tend to collapse and fail in service. Use the towing thimble shown in [Figure 613-2-30](#) (NAVSEA dwg 803-6397321).

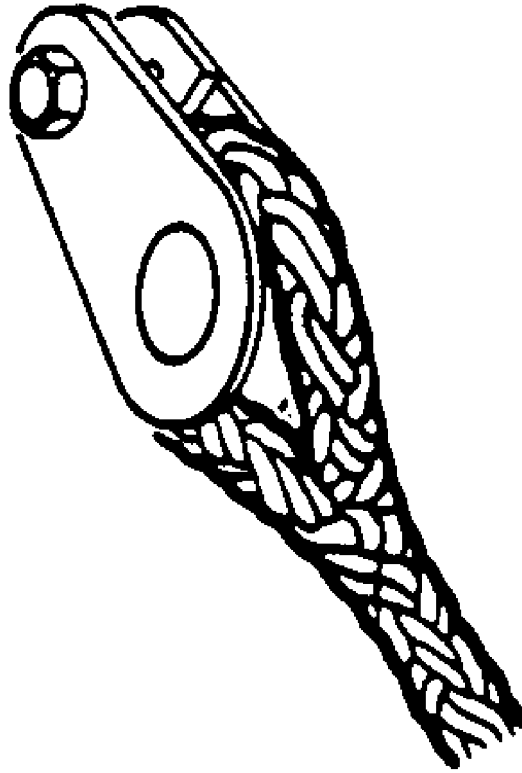

Figure 613-2-30. Towing Thimble

613-2.13.11 SPECIAL THIMBLES. Thimbles for critical applications such as highlines shall be in accordance with MIL-T-23326, and are available at DISC under class 4030. These thimbles, made from aluminum bronze, are so configured that the rope will not slip off when stretched.

613-2.13.12 THIMBLES AND SHACKLES. Thimbles and shackles conforming to the following specifications may be used in conjunction with synthetic fiber ropes.

1. Thimbles - FED Spec FF-T-276
2. Shackles - RR-C-271

613-2.13.13 THIMBLE USAGE. Care shall be taken when thimbles conforming to FF-T-276 are used, because synthetic rope tends to ride out of the groove and shear the walls. Thimble edges will then cut the fibers. Authorized usage of FF-T-276 thimbles are as follows:

1. Type I round thimbles are acceptable for use with synthetic ropes up to 2-1/2-inch circumference.
2. Type II tear drop thimbles are acceptable for use where the normal working load does not exceed 5 percent of the synthetic rope breaking strength.
3. Type III tear drop thimbles are acceptable for use where the normal working load of synthetic rope is to be utilized (see paragraph [613-2.10](#)).

WARNING

Thimbles shall fit snugly into the rope's eye, and a throat seizing shall be applied to the rope at the base of the thimble to prevent slippage.

613-2.14 PRECAUTIONS FOR USING SYNTHETIC FIBER ROPES

613-2.14.1 GENERAL. Precautions to be taken when utilizing synthetic fiber rope are covered in paragraphs 613-2.14.2 through 613-2.14.10.

613-2.14.2 SINGLE-PART HANDLING. Braided or plaited rope shall be used for single-part handling of a freely-rotating load. Never use plain-laid ropes in single-part to haul or hoist loads that are free to rotate because these ropes will unlay and develop strength-reducing cockles.

WARNING

Synthetic rope may fail without warning, which could be catastrophic. To prevent serious injury or death from snapback action, personnel shall not stand in direct line of pull under any load.

613-2.14.3 ROPE ELONGATION. If nylon ropes are stretched 1-2/5 to 1-3/5 their original length or polyester ropes are stretched 1-1/5 to 1-2/5 their original length (depending on construction) they will part and upon parting, return instantaneously to their original length (snapback) with deadly force. Personnel shall therefore not stand in the direct line of pull.

WARNING

Personnel tending lines on bitts or capstans shall stand clear of the area within 45 degrees either side of the straight line path to prevent injury from snapback action.

613-2.14.4 REBONDING OF BITT AND CAPSTAN LINES. The force applied to lines on bitts or capstans is such that, upon parting, these lines rebound (snap back) in a sweeping motion or in a straight line. Since this rebounding presents a danger to line-handling personnel, the linehandlers shall work in an area outside of 45 degrees on either side of the straight line path area. Aramid rope is designed to fail sequentially, meaning that one strand is designed to fail before any subsequent failure. However, this has only been demonstrated in short lengths (up to 50 feet), and this rope should be treated with the same respect afforded any rope under tension. Observe all standard safety precautions for handling ropes under tension.

613-2.14.5 SURGING ON BITT AND CLEAT LINES. Another potential danger to the linetender is the sudden surging of lines on bitts or cleats. To avoid being drawn into the bitts or cleats, personnel shall remain away

S9086-UU-STM-010/CH-613R3

from the bitts at a distance equal to the length of the line bent on the bitt. This applies equally to aramid line, which surges more smoothly around bitts than other synthetic mooring lines.

613-2.14.6 EASING-OUT AND CHECKING LINES. Exercise extreme care when easing out (relaxing the strain) or checking (allowing only enough line to render around the fitting to prevent a line from parting) synthetic lines. Because of their rapid recovery, low coefficient of friction and high extensibility under heavy loads, these lines may slip suddenly on easing out or checking, thereby causing injury to line handlers. For control in easing out, take no more than two round turns on a cleat or bitt. For checking a line under strain, take two round turns followed by no more than two figure-eight bends. Because figure-eight bends tend to lock up and surge unexpectedly, the use of figure-eights in easing out or more than two figure-eights in checking will present a danger to personnel and cause extreme difficulty in handling lines.

613-2.14.7 MAKING A SIDE TOW HITCH. The correct use of round turns and figure-eight bends provides closer control in making a side-tow hitch while easing-out or surging, which is illustrated in [Figure 613-2-31](#).

613-2.14.8 DOUBLING-UP SYNTHETIC MOORING LINES. In addition to the single part of a mooring line at each bitt, a bight of the line is passed to the pier or other ship which gives three parts of line holding the ship. To ensure that the three parts of line take an equal strain, a simple turn is taken on the first barrel of the ship's bitt closest to the chock before passing the bight over. After the slack is taken out of the bight, fairlead the standing part to the second barrel and figure-eight the line as illustrated in [Figure 613-2-32](#).

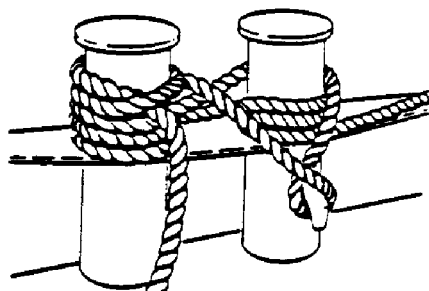

Figure 613-2-31. Correct Method of Making a Side-Tow Hitch

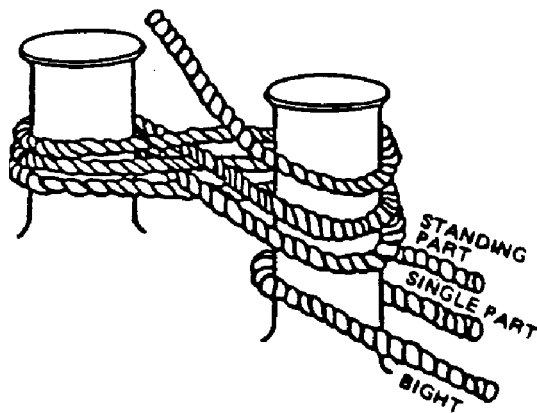

Figure 613-2-32. Correct Method for Doubling-Up

613-2.14.9 STOPPER. The use of a synthetic rope stopper is required to hold the strain on a single part of a mooring line while passing the bight over. The eye or bight of the stopper is passed around the barrel of the bitt closest to the chock or through the padeye at the base of the bitt if provided.

613-2.14.10 SYNTHETIC FIBER ROPE'S LIFE EXPECTANCY. Synthetic fiber ropes, properly handled and maintained, should remain serviceable more than five times as long as manila rope (if usage is similar). Adherence to the preceding instructions, as well as to customary safe rope usage practices, is imperative in order to derive all advantages inherent in synthetic fiber rope and to conserve cordage allowances.

613-2.15 CRITERIA FOR ESTIMATING USED ROPE SERVICEABILITY

613-2.15.1 GENERAL. The serviceability of used rope is determined by visual inspection and evaluation based on the criteria presented in paragraphs [613-2.15.2](#) through [613-2.15.9](#).

613-2.15.2 ROPE WEAR. Synthetic rope external wear is characterized by a fine nap or fuzz distributed uniformly on strand surfaces. A worn rope with a strength loss of less than 10 percent is illustrated in [Figure 613-2-33](#). Internal wear may be noted as a fuzzed or fused condition between strands. Natural fiber rope external wear is indicated by flattened areas (where fibers have broken away). With initial wear, natural rope section will have clean inner fibers, the ends of which protrude from twisted inner strands. Internal wear may be detected as a powdery appearance between the strands.



Figure 613-2-33. Synthetic Rope Showing Fuzzy Nap as a Result of Normal Wear

613-2.15.3 BREAKING STRENGTH LOSS. The strength of fiber ropes can be reduced significantly from shock loading, and dynamic loading at high levels. Similarly cut and worn strands affect the strength of the rope. To determine the replacement criteria for fiber rope, refer to [Table 613-2-6](#).

613-2.15.4 CHAFING. Synthetic rope chafing can be identified by the presence of a hard outer layer composed of fibers fused together by frictional heat. (The friction is caused by abrasion when the rope surges under heavy loads.) Typical synthetic fiber rope chafing is shown in [Figure 613-2-36](#). Chafing in natural fiber ropes appears as localized broken yarns which hang from the rope. These chafed ropes are troublesome in running rigging because they foul on blocks, sheaves, and capstans. (See [Table 613-2-6](#).)

613-2.15.5 STRETCHOUT. A visible reduction in rope circumference is indicative of stretchout (usually a result of excessive loading). To determine stretchout, both the circumference of the reduced area and that of a normal rope section shall be measured. (See [Table 613-2-6](#).)

613-2.15.6 CUTTING. A synthetic rope damaged by cutting will usually show brooming and yarn end protrusion as illustrated in [Figure 613-2-35](#). Remove cut portions of rope and splice good portions back together. The rope may then be returned to service.

613-2.15.7 COCKLING. A localized distortion formed by a back twisted strand (resulting from unbalance) is known as cockling. This condition occurs in natural fiber ropes because of overloading. Synthetic rope cockling is shown in [Figure 613-2-34](#). Because cockling reduces breaking strength, cut out cockled rope sections and splice the remaining rope to ensure continuing safe service.



Figure 613-2-34. Synthetic Rope Containing a Cockle



Figure 613-2-35. Synthetic Rope Showing Cut Condition

613-2.15.8 RUST. Rust can be recognized by the characteristic reddish-brown to brownish-black color. Ordinarily, rust stains appear in localized rope areas because of contact with corroding steel ([Figure 613-2-37](#)). Rust will not stain polypropylene or appreciably reduce the strength of polyester. Stains that are removable with soap and water on other fiber ropes have no adverse effects on rope strength. However, persistent stains extending into the cross-section of natural fiber and nylon fiber yarns can lower rope strength. Cut out the rust area of the rope and splice the remaining rope to ensure continuing safe service.



Figure 613-2-36. Synthetic Rope Showing Surface Fusion and Chafing



Figure 613-2-37. Rope Showing Rust Damage

613-2.15.9 CUMULATIVE EFFECT OF SERVICEABILITY FACTORS. Factors such as internal and external wear, chafing, stretchout, cutting, cockling, and rust stains have a cumulative effect when present in the same rope section. When in doubt remove from service.

613-2.15.10 INSPECTION GUIDELINES. Rope technology has not yet advanced to the point where a rope can be visually inspected to determine exact extent of damage. The Inspection Guidelines in [Table 613-2-6](#) are recommended for use as appropriate.

Table 613-2-6. ROPE INSPECTION GUIDELINES

Characteristics	Resplice (If Localized)	Replace
1. Rope suspected of being shock loaded.		X
2. Rope that has exceeded 75 percent of its minimum breaking strength.		X
3. Bulk of surface yarns or strands	X	X
4. Three or more adjacent cut yarns in the strands of ropes to 4-1/2 inch circumference.	X	X
5. Four or more adjacent cut yarns in the strands of ropes 5-inch circumference and over.	X	X
6. Stretchout: Circumference reduced by 5 percent from circumference when new. (Measured under a slight tension 200xD2 in pounds)		X
7. Cockling	X	
8. Oil and grease	Wash in mild detergent	
9. Heavy surface fuzz progressive. Remove source of abrasion	X	
10. Burns or melting visible for a length of over four times the rope circumference.	X	X
11. Rust on nylon	X (or celan)	
		FOR BRAIDED ROPES
12. More than four adjacent pulled cover strands (which cannot be reincorporated into cover braid).	X	X
13. Core visible through cover because of cover damage (except single braids).	X	X
14. Core damage - pulled, cut, abraded, or melted strands		X
FOR 3-STRAND AND 8-STRAND PLAITED ROPES		
15. Damage in valley between strands	X	X
16. Powdering between adjacent strand contact surfaces.	X	X
WHEN IN DOUBT, REMOVE FROM SERVICE!		

SECTION 3.

RIGGING

613-3.1 INTRODUCTION

613-3.1.1 This section discusses standing rigging preparation, adjustment, insulation, and grounding.

S9086-UU-STM-010/CH-613R3

613-3.2 STANDING RIGGING REQUIREMENTS

613-3.2.1 GENERAL. Standing rigging is used to support masts and is generally comprised of shrouds supporting the mast athwartships and stays supporting the mast in fore and aft directions. Normally, standing rigging is fabricated using 6 by 19 galvanized improved plow steel wire rope and terminated with poured sockets, Fiege-type connectors, swaged fittings, or manual eye splices as specified. Approved methods for the installation of poured sockets and splices are provided in [Section 1](#) of this chapter.

613-3.2.2 SPLICING AND SERVING. Metallic standing rigging that has been manually spliced shall be wormed, parceled, and served in the area of splices, thimbles and in places where chafing is likely.

613-3.2.3 PREPARATION. Before worming, parceling, and serving (paragraphs [613-3.2.4](#) through [613-3.2.7](#)), wire rope shall be thoroughly clean and free from rust and shall be coated with sea water wash resistant grease, CID A-A-50433, NSN 9G-9150-01-306-9167. Care shall be taken that the grease is worked into the lays of the rope.

613-3.2.4 WORMING. After the grease (CID A-A-50433) is applied, wire rope 3/4 inch in diameter and larger shall be wormed with tarred hemp seizing, and sized as necessary to work smoothly into the lays of the rope. Rope less than 3/4 inch in diameter shall not be wormed.

613-3.2.5 PARCELING. Parceling shall be applied with the lay of the rope, using cotton cloth sheeting in strips approximately 3 inches wide. Each turn shall overlap the other 1/2 its width, so that it forms double thickness.

613-3.2.6 SERVING. After parceling, wire rope up to 7/16 in diameter shall be served with marline. Wire rope 7/16 inch to 1 inch in diameter shall be served with round line, tight and against the lay of the rope.

613-3.2.7 DOUBLE SERVING. Wire rope 7/8 inch in diameter and larger, which is spliced around a thimble, shall be double served over the splice; the length of first serving shall equal once around the thimble plus the circumference of the rope; the length of the second serving shall equal once around the thimble plus twice the circumference of the rope. After the first serving, parceling shall be applied, as described above, for the limits stated for the second serving. For wire rope 3/4 inch in diameter and smaller, only a single serving shall be applied and the length of the serving shall equal once around the thimble plus twice the circumference of the rope.

613-3.3 INSTALLATION

613-3.3.1 Stays and shrouds in the vicinity of the ship armament line-of-fire, or those that have to be disconnected quickly, as in boom handling, are set up with rigging screws, using pelican hooks, according to NAVSEA dwg 804-860234. Shrouds and stays not required to be disconnected are set up with turnbuckles equipped with locking nuts.

613-3.4 ADJUSTMENT

613-3.4.1 Periodically inspect standing rigging and tighten, if necessary, because the effectiveness of shrouds and stays is significantly reduced if they are allowed to become slack. When extensive adjustments are required, use the following procedures:

1. Slacken all stays so that no unbalanced forces will be applied to mast.
2. Take up slack as uniformly as possible until sag is substantially eliminated from all stays and until turnbuckles are handtight.
3. Measure distances between the ends of turnbuckle bolts.
4. Tighten each turnbuckle until it is shortened by a distance equal to 1 inch for each 60 feet of stay length.

613-3.5 INSULATORS

613-3.5.1 Installation requirements for rigging insulators are as follows:

1. Insert porcelain insulators, or insulators of other approved material, into the metallic rigging in all surface ships in which radio equipment is installed.
2. Fit one rigging insulator near the top of each member of standing rigging and ladder. The lower ends of rigging shall be securely and efficiently grounded.
3. Regardless of the wire rope size used, rigging insulators shall not be fitted into supporting shrouds and stays for boom-equipped kingposts that handle heavy loads.
4. Both ends of all uninsulated stays shall be thoroughly permanently grounded.
5. Insulators shall have clean surfaces and shall not be painted, tarred, varnished, or coated. At no point where rigging comes into contact with insulators shall parceling, seizing, or tar be allowed. Coat the rigging in the vicinity of insulators with sea water wash resistant grease, CID A-A-50433, NSN 9G-9150-01-306-9167.
6. Use iron wire seizing over splices to secure insulators in rigging. Parcel and serve rigging with marline at splices only where corrosion is likely to begin.

613-3.6 GROUNDING

613-3.6.1 Unless specifically directed to the contrary, ground the mast stays at the deck to prevent accumulation of static charges. To avoid formation of loops by the grounded mast stays, and to reduce the magnitude of radio direction-finder deviation, insert a rigging insulator near the top of each mast stay. The foregoing, however, does not apply to ships fitted with high-frequency direction-finding equipment. Rigging on these ships shall be broken by insulators in such a manner that no ungrounded portion is longer than 15 feet and no grounded portion is longer than 8 feet.

613-3.7 CHARRING OF WOOD

613-3.7.1 To prevent charring of wood masts, spars, and other wood structures, ground all metal fittings on these items with a copper strip at least 1 inch by 1/32 inch.

613-3.8 INSULATION AND GROUNDING

613-3.8.1 Rigging insulation and grounding shall comply with NAVSEA dwg 805-921939. Periodically inspect all electrical grounds on metallic standing rigging and ladders for excessive deterioration at points of contact between dissimilar metals. Clean connections and apply new parceling and serving as necessary (see paragraph [613-3.2.2](#)).

S9086-UU-STM-010/CH-613R3

613-3.9 REFERENCES

613-3.9.1 Wire rope inspection, care, replacement, and splicing information is provided in [Section 1](#) of this chapter.

613-3.9.2 Technical information for wire rope rigging design is given in NAVSEA Design Data Sheet DDS 613-1, **Wire Rope Systems Design** .

613-3.9.3 Standing rigging design information is given in NAVSEA Design Data Sheet DDS 170-0, **Mast Design** .

REAR SECTION

NOTE

TECHNICAL MANUAL DEFICIENCY/EVALUATION EVALUATION REPORT (TMDER) Forms can be found at the bottom of the CD list of books. Click on the TMDER form to display the form.

