

AD-A142 470

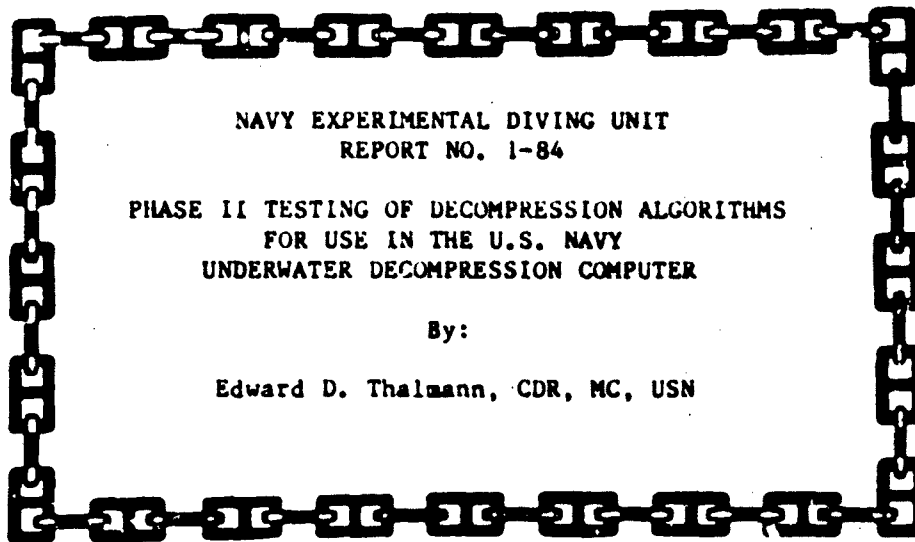

NAVY EXPERIMENTAL DIVING UNIT
REPORT NO. 1-84

PHASE II TESTING OF DECOMPRESSION ALGORITHMS
FOR USE IN THE U.S. NAVY
UNDERWATER DECOMPRESSION COMPUTER

By:

Edward D. Thalmann, CDR, MC, USN

NAVY EXPERIMENTAL DIVING UNIT



DTC FILE COPY

Reproduced From
Best Available Copy

84 06 26 038

20000803097



DEPARTMENT OF THE NAVY
NAVY EXPERIMENTAL DIVING UNIT
PANAMA CITY, FLORIDA 32407

IN REPLY REFER TO:

NAVY EXPERIMENTAL DIVING UNIT
REPORT NO. 1-84

PHASE II TESTING OF DECOMPRESSION ALGORITHMS
FOR USE IN THE U.S. NAVY
UNDERWATER DECOMPRESSION COMPUTER

By:

Edward D. Thalmann, CDR, MC, USN

JANUARY 1984

Approved for public release; distribution unlimited.

Submitted by:

E. D. THALMANN
CDR, MC, USN
Senior Medical Officer

Approved by:

FRANK E. EISSING
CDR, USN
Commanding Officer

UNCLASSIFIED

SECURITY CLASSIFICATION OF THIS PAGE (When Data Entered)

REPORT DOCUMENTATION PAGE		READ INSTRUCTIONS BEFORE COMPLETING FORM										
1. REPORT NUMBER	2. GOVT ACCESSION NO.	3. RECIPIENT'S CATALOG NUMBER										
NEDU REPORT 1-84												
4. TITLE (and Subtitle)		5. TYPE OF REPORT & PERIOD COVERED										
PHASE II TESTING OF DECOMPRESSION ALGORITHMS FOR USE IN THE U.S. NAVY UNDERWATER DECOMPRESSION COMPUTER		FINAL										
		6. PERFORMING ORG. REPORT NUMBER										
7. AUTHOR(s)		8. CONTRACT OR GRANT NUMBER(s)										
EDWARD D. THAIMANN, CDR, MC, USN												
9. PERFORMING ORGANIZATION NAME AND ADDRESS		10. PROGRAM ELEMENT PROJECT, TASK AREA & WORK UNIT NUMBERS										
NAVY EXPERIMENTAL DIVING UNIT PANAMA CITY, FL 32407												
11. CONTROLLING OFFICE NAME AND ADDRESS		12. REPORT DATE										
		JANUARY 1984										
		13. NUMBER OF PAGES										
14. MONITORING AGENCY NAME & ADDRESS (if different from Controlling Office)		15. SECURITY CLASS. (of this report)										
		UNCLASSIFIED										
		15a. DECLASSIFICATION/DOWNGRADING SCHEDULE										
16. DISTRIBUTION STATEMENT (of this Report)												
Approved for public release; distribution unlimited.												
17. DISTRIBUTION STATEMENT (of the abstract entered in Block 20, if different from Report)												
18. SUPPLEMENTARY NOTES												
19. KEY WORDS (Continue on reverse side if necessary and identify by block number)												
<table border="0"> <tr> <td>Air Tables</td> <td>Decompression Sickness Nitrogen-Oxygen Tables</td> </tr> <tr> <td>Computer Algorithm</td> <td>Decompression Tables Repetitive Diving</td> </tr> <tr> <td>Computer Model</td> <td>Mathematical Model</td> </tr> <tr> <td>Constant Oxygen Partial Pressure</td> <td>MK 15 UBA</td> </tr> <tr> <td>Decompression Model</td> <td>MK 16 UBA</td> </tr> </table>			Air Tables	Decompression Sickness Nitrogen-Oxygen Tables	Computer Algorithm	Decompression Tables Repetitive Diving	Computer Model	Mathematical Model	Constant Oxygen Partial Pressure	MK 15 UBA	Decompression Model	MK 16 UBA
Air Tables	Decompression Sickness Nitrogen-Oxygen Tables											
Computer Algorithm	Decompression Tables Repetitive Diving											
Computer Model	Mathematical Model											
Constant Oxygen Partial Pressure	MK 15 UBA											
Decompression Model	MK 16 UBA											
20. ABSTRACT (Continue on reverse side if necessary and identify by block number)												
<p>Results of the second phase of man-testing a computer algorithm for computing decompression profiles breathing 0.7 ATA oxygen in nitrogen are presented. This algorithm is primarily for use with the MK 15 or MK 16 closed circuit UBA. This Phase II testing was designed to lengthen the no-decompression limits established in the previously reported Phase I testing and to gain more experience in the 100-150 FSW depth range. Some 228 man dives resulting in 11 cases of Type I decompression sickness were conducted.</p>												

DD FORM
1 JAN 73 1473EDITION OF 1 NOV 65 IS OBSOLETE
S/N C102-LF 014-AAD1

UNCLASSIFIED

UNCLASSIFIED

SECURITY CLASSIFICATION OF THIS PAGE (When Data Entered)

During the course of Phase II testing, the decompression model had to be changed. Initially, the model used in Phase I testing was used (exponential gas uptake and offgassing, 9 tissues ranging from 5 min to 240 min halftime), but testing showed this model predicted inadequate decompression profiles for repetitive dives. The Phase I model was modified so gas uptake was exponential but gas elimination was linear. This linear offgassing modeled the elimination of a gas phase with instantaneous diffusion in a well-mixed compartment. Three different sets of ascent criteria were tested using this modified model. The final set of ascent criteria produced an acceptable algorithm with an expected maximum incidence of decompression sickness less than 3.5% assuming that occurrence followed the binomial distribution at the 95% confidence level. The report gives complete details of the decompression model derivation as well as detailed flow charts for all algorithms. All tested ascent criteria and test profiles are presented along with complete descriptions of all cases of decompression sickness.

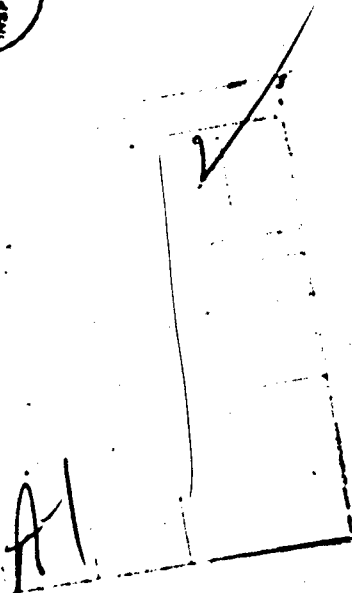

UNCLASSIFIED

SECURITY CLASSIFICATION OF THIS PAGE (When Data Entered)

TABLE OF CONTENTS

	<u>Page</u>
ABSTRACT.....	iv
GLOSSARY.....	v
INTRODUCTION.....	1
DECOMPRESSION MODEL.....	1
Gas Uptake and Elimination Equations.....	5
Ascent Criteria.....	7
Warning Status.....	15
Computer Algorithms.....	15
Exponential-Exponential Model.....	15
Exponential-Linear Model.....	17
Safe Ascent Depth and Warning Status.....	17
METHODS.....	20
Test Profiles.....	24
RESULTS.....	26
DISCUSSION.....	33
Offgassing During Surface Interval.....	35
Comparison With Air Tables.....	36
Final Ascent Criteria Statistics.....	39
Decompression Sickness Symptoms.....	43
Decompression Tables.....	44
Summarization.....	45
CONCLUSIONS AND RECOMMENDATIONS.....	46
REFERENCES.....	47
FIGURES	
FIGURE 1 - U.S. Navy Prototype Underwater Decompression Computer.....	2
FIGURE 2 - UDC Algorithm Configuration.....	4
FIGURE 3 - E-E Algorithm Flowchart.....	16
FIGURE 4 - E-L Algorithm Flowchart.....	18
FIGURE 5 - SAD and Warning Status Flowchart.....	19
FIGURE 6 - Typical Dive Profile.....	23
TABLES	
TABLE 1 - MVAL5 Ascent Criteria.....	8
TABLE 2 - MVAL83 Ascent Criteria.....	9
TABLE 3 - MVAL92 Ascent Criteria.....	10
TABLE 4 - MVAL97 Ascent Criteria.....	11
TABLE 5 - VVAL09 Ascent Criteria.....	12
TABLE 6 - VVAL14 Ascent Criteria.....	13
TABLE 7 - VVAL18 Ascent Criteria.....	14
TABLE 8 - Physical Characteristics of Divers.....	21
TABLE 9 - Phase II Profiles.....	25
TABLE 10- Phase II Test Dive Results.....	27

TABLE OF CONTENTS
(Continued)

	<u>Page</u>
TABLE 11- Decompression Sickness Descriptions.....	28
TABLE 12- Individual Diving Intensity.....	29
TABLE 13- Phase II No-Decompression Times.....	30
TABLE 14- Comparison of No-Decompression Limits at Equivalent Nitrogen Depths.....	37
TABLE 15- Summary of Man-Dives and Decompression Sickness Incidence.....	41

APPENDICES

Appendix A

Derivation of MK 15/16 0.7 ATA Fixed PO_2 in Nitrogen
Decompression Model Gas Uptake and Elimination Equations.

INTRODUCTION.....	A-1
EXPONENTIAL-EXPONENTIAL (E-E) MODEL.....	A-1
EXPONENTIAL-LINEAR (E-L) MODEL.....	A-5
FIGURE A-1 Conceptual Presentation of Gas Uptake and Elimination...	A-2
FIGURE A-2 Gas Uptake and Elimination.....	A-13

Appendix B

MK 15/16 Real Time Algorithm Error Analysis.

TABLE B-1 Cumulative Error (FSW) Per Foot of Depth Change.....	B-8
--	-----

Appendix C

Dive Profile Comparisons.

Profile 3.....	C-1
Profile 4.....	C-2
Profile 5.....	C-3
Profile 6.....	C-4
Profile 7.....	C-5
Profile 8.....	C-6
Profile 9.....	C-7
Profile 10.....	C-8
Profile 11.....	C-9
Profile 12.....	C-10

PHASE IX PROFILES

Profile 20.....	C-11
Profile 21.....	C-12
Profile 22.....	C-13
Profile 23.....	C-14
Profile 24.....	C-15
Profile 24A.....	C-16
Profile 25A.....	C-17
Profile 26.....	C-18
Profile 27.....	C-19
Profile 28.....	C-20
Profile 29.....	C-21
Profile 30.....	C-22

Appendix D

MK 15/16 0.7 ATA Constant PO₂ in N₂ Decompression Tables.

RULES.....	D-1
-------------------	------------

DECOMPRESSION TABLES

Depth in Feet, Stop Depth Increments 10 Feet.....	D-3
VVAL18 for 10 FSW Stop Depth Increments.....	D-4
Beginning of Tables.....	D-5
Depth in Meters, Stop Depth Increments 3 Meters.....	D-15
VVAL18 for 3 MSW Stop Depth Increments.....	D-16
Beginning of Tables.....	D-17

TABLE D-1 RULES FOR USING 0.7 ATA CONSTANT PO₂ IN NITROGEN DECOMPRESSION TABLES.....	D-2
--	------------

ABSTRACT

Results of the second phase of man-testing a computer algorithm for computing decompression profiles breathing 0.7 ATA oxygen in nitrogen are presented. This algorithm is primarily for use with the MK 15 or MK 16 closed circuit UBA. This Phase II testing was designed to lengthen the no-decompression limits established in the previously reported Phase I testing and to gain more experience in the 100-150 FSW depth range. Some 228 man dives resulting in 11 cases of Type I decompression sickness were conducted. During the course of Phase II testing, the decompression model had to be changed. Initially, the model used in Phase I testing was used (exponential gas uptake and offgassing, 9 tissues ranging from 5 min to 240 min halftime), but testing showed this model predicted inadequate decompression profiles for repetitive dives. The Phase I model was modified so gas uptake was exponential but gas elimination was linear. This linear offgassing modeled the elimination of a gas phase with instantaneous diffusion in a well-mixed compartment. Three different sets of ascent criteria were tested using this modified model. The final set of ascent criteria produced an acceptable algorithm with an expected maximum incidence of decompression sickness less than 3.5% assuming that occurrence followed the binomial distribution at the 95% confidence level. The report gives complete details of the decompression model derivation as well as detailed flow charts for all algorithms. All tested ascent criteria and test profiles are presented along with complete descriptions of all cases of decompression sickness.

KEY WORDS

Air Tables
Computer Algorithm
Computer Model
Constant Oxygen Partial Pressure
Decompression Model
Decompression Sickness
Decompression Tables
Mathematical Model
MK 15 UBA
MK 16 UBA
Nitrogen-Oxygen Tables
Repetitive Diving

GLOSSARY

- Algorithm** - A sequence of logical steps used to obtain a mathematical result.
- Decompression Profile** - A table or graph showing the time/depth coordinates for an entire dive including all desired stops and all obligatory decompression stops.
- Decompression Schedule** - A listing showing required decompression stop depths and stop times for particular Bottom Depth/Time dive.
- Decompression Table** - A structured set of decompression schedules usually organized in order of increasing Bottom Depths and Bottom Times.
- Dive Profile** - A table or graph of time/depth coordinates for an entire dive showing all desired stops without regard to decompression obligation.
- No-Decompression Time** - The maximum time which can be spent at a given depth such that ascent can be safely made directly to the surface at a prescribed rate.

INTRODUCTION

In March of 1978 the U.S. Navy Experimental Diving Unit (NEDU) completed the first phase of a dive series designed to test a computer algorithm for computing decompression schedules for the MK 15 Underwater Breathing Apparatus (UBA). This algorithm assumes that the diver is breathing a gas containing a constant 0.7 ± 0.1 ATA partial pressure of oxygen in a nitrogen diluent. The results of this Phase I testing have already been reported (1). The no-decompression limits computed by the Phase I algorithm appeared much too short when compared to limits in tables already published. This resulted from the fact that Phase I testing consisted only of multiple depth repetitive dives in the 75-175 FSW range which was the primary area of interest at the time testing commenced. No-decompression limits were calculated from extrapolation of ascent criteria used for deeper dives using an empirically derived equation (1).

There were two other shortcomings of the decompression schedules resulting from Phase I testing. The first was that because of technical considerations no surface interval was ever taken at 1 ATA. The wet chamber was brought to 4 FSW and during "surface intervals" the divers remained in the wet chamber under 6 FSW of water (total depth 10 FSW), only exiting the wetpot after the last dive. This meant that besides being at a depth of 10 FSW, they were breathing a 0.7 ATA P_{O_2} for the entire dive profile which did not reflect what would occur operationally where they would be breathing air at 1 ATA during any surface intervals. Another shortcoming of Phase I testing was the inability to conduct dives at the 150 FSW depth without an unacceptable incidence of decompression sickness. It was felt that more experience was required on dives of this depth.

This report describes the results of the 233 man dives comprising Phase II testing that eventually resulted in an improvement upon the Phase I algorithm. This included substantially longer no-decompression limits as well as additional experience with deeper depth decompression dives.

DECOMPRESSION MODEL

The computer algorithms used in this dive series are real time algorithms developed for eventual inclusion into a microprocessor controlled wrist-worn Underwater Decompression Computer (UDC) (Figure 1). In the course of developing the algorithms a set of programs had to be written which would allow decompression profiles and sets of decompression tables to be computed from theoretical dive profiles input from a terminal or file on a mass storage device. Also, at the completion of testing, programs had to be written which would compute a complete set of decompression tables in U.S. Navy format based on the real time algorithm. The two programs eventually written for these purposes were Program DMDB7 for computing individual decompression profiles for dive profiles of essentially unlimited complexity and Program TBLP7 for computing a set of decompression tables in standard U.S. Navy format for single bounce dives. Both Program DMDB7 and TBLP7 are input/output programs only and require 8 subroutines which describe the decompression model. Programs DMDB7 and TBLP7 along with the 8 Decompression Model Subroutines are described in detail elsewhere (5).

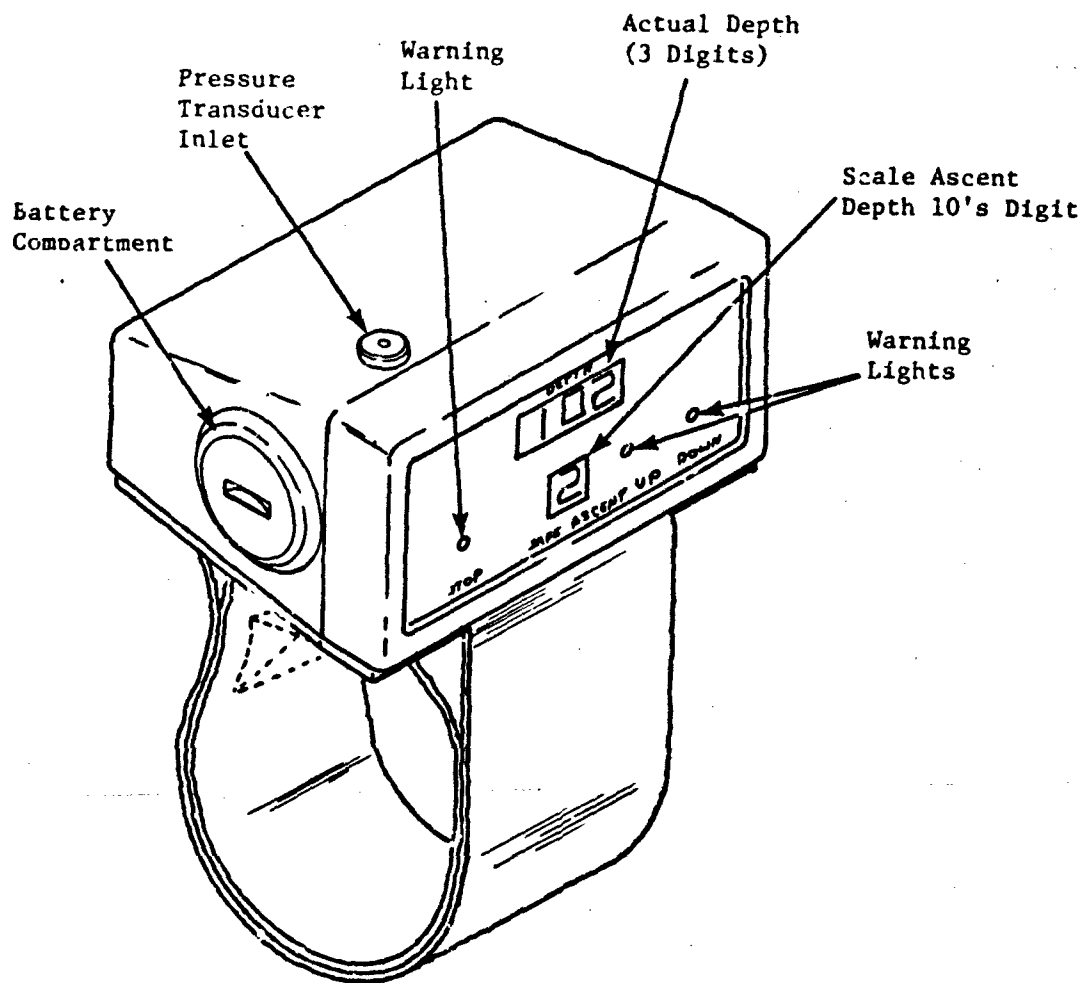

FIGURE 1. A prototype Underwater Decompression Computer (UDC). This unit has only the essential readouts for safely informing the diver of his decompression status. This UDC shows a diver depth of 102 feet and a Safe Ascent Depth of 20 feet. To decompress, the diver ascends until the Depth Readout shows 020 feet and waits until the SAD readout decreases to 1 at which point he can ascent to 010 feet. The STOP warning light comes on when the diver is at his SAD. The UP light is on if deeper than the SAD and the DOWN light comes on if shallower than the SAD.

The real time computer algorithms which will be discussed here were based on the Subroutine UPDT7 of reference 5. The Subroutine UPDT7 is considerably more complex than the real time algorithm because it must perform several rather complicated look ahead functions to determine at what point in time certain assumptions take effect. The real time algorithm need not perform these functions since it only needs to determine what conditions exist at the time it runs.

The real time algorithm is based on a set of assumptions about the biophysical events leading up to the occurrence of decompression sickness. These assumptions when translated into mathematical equations constitute a decompression model. The decompression model described here was initially developed for use with the MK 15 UBA but was eventually extended for use with the MK 16 UBA. Both UBA's function identically in that they electronically control the PO₂ to a preset value independent of depth using any desired inert gas as a diluent, the UBA's differ only in the materials from which they are constructed. The decompression model will be referred to as the MK 15/16 Decompression Model. The real time algorithm developed from the MK 15/16 Decompression Model will be referred to as the MK 15/16 Real Time Algorithm (MK 15/16 RTA).

During the course of testing, two versions of the MK 15/16 RTA were eventually written. The first version assumed that both gas uptake and elimination by body tissue could be described exponentially and is known as the Exponential-Exponential or E-E Version. Later, a second version evolved from the E-E Version which assumed gas uptake was exponential but gas elimination was linear. This was known as the Exponential-Linear or E-L Version. A detailed derivation of the E-E and E-L Versions of the MK 15/16 Decompression Model is given in Appendix A of this report; what follows is a general discussion of the model necessary for interpretation of the results of this test dive series.

The overall scheme of the MK 15/16 RTA is shown in Figure 2. The algorithm runs every two seconds and completes its calculations in substantially less time than the two second interval between successive runs. The only external variable input during the execution of the algorithm is depth. All other variables (type of inert gas, partial pressure of oxygen, etc.) are assumed either constant throughout the entire dive or a function only of depth.

The algorithm first samples depth then uses this value to update the gas tensions in the 9 theoretical halftime tissues using the Gas Uptake and Elimination Equations. The updating of tissue tensions continues over the entire course of the dive and at any given time the 9 tissue tensions reflect the cumulative gas tension for the entire preceding dive profile. The algorithm then compares these tissue tensions with the ascent criteria which are maximum permissible tissue (inert gas) tensions (MPTT) at each of the 10 FSW incremental stop depths. The algorithm determines the shallowest stop depth at which none of the current tissue tensions will be greater than their respective MPTT. This depth is displayed as the Safe Ascent Depth or SAD.

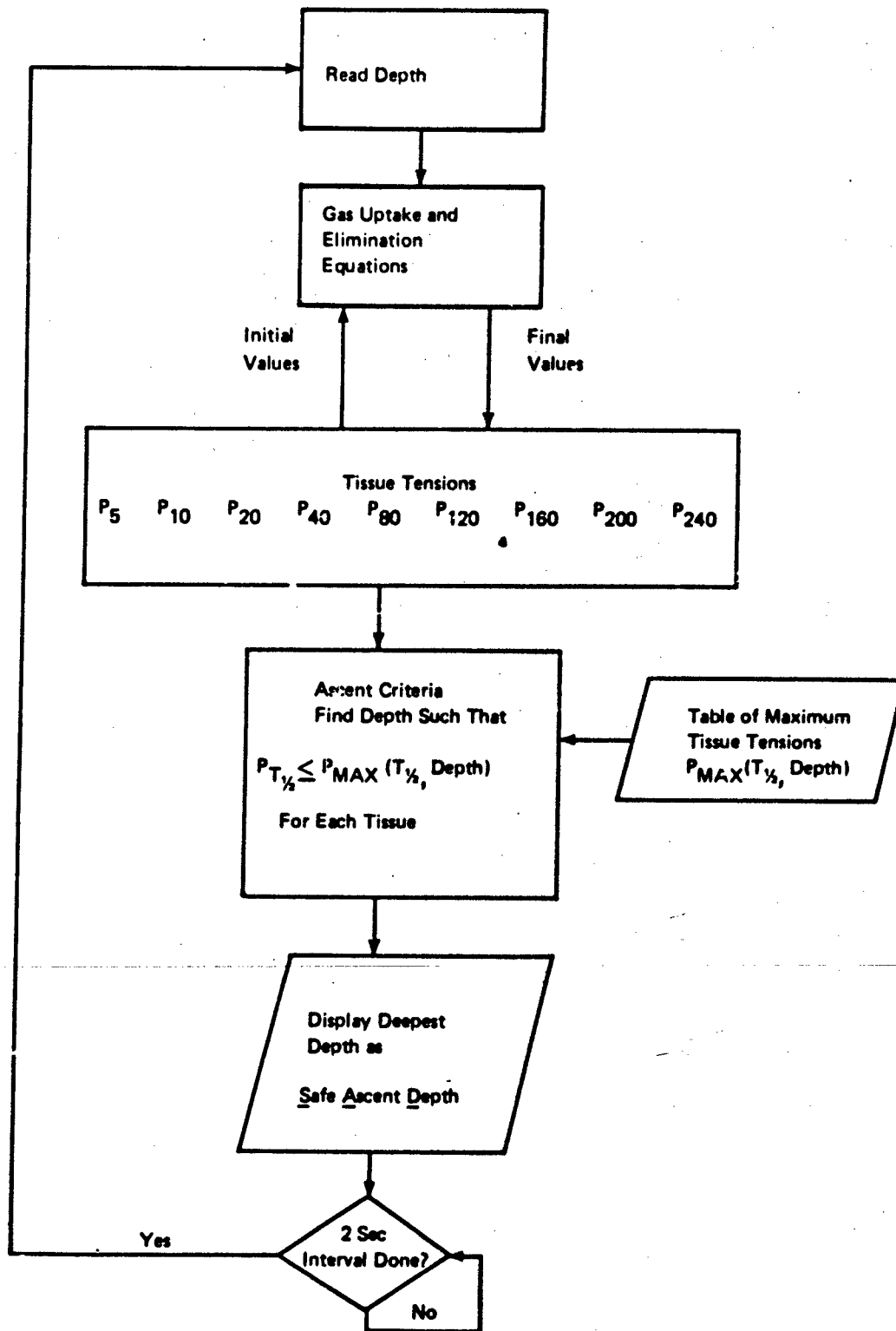

FIGURE 2. UDC ALGORITHM CONFIGURATION. ALGORITHM IS EXECUTED EVERY TWO SECONDS

Once the SAD has been computed, the algorithm performs some checks to see if the diver is outside of the tested decompression model limits and then it pauses until the remainder of the two second interval between runs has elapsed, at which point it begins execution again. The diver's current depth and SAD are displayed continuously by the UDC (Figure 1). As long as the diver remains below the SAD, he is not violating any ascent criteria. To decompress, the diver ascends to the displayed SAD and waits for the SAD to decrement to the next 10 FSW shallower stop. By matching his depth to the displayed SAD the diver will eventually decompress to the surface.

Gas Uptake and Elimination Equations

Gas uptake and elimination for the E-E Model are both described by the equation:

$$(1) \quad P_{T_{N_2}} = P_{a_{N_2}} + (P_{T_{i_{N_2}}} - P_{a_{N_2}}) \cdot e^{-K \cdot T}$$

where:

$P_{T_{N_2}}$ = tissue inert gas tension after time T

$P_{a_{N_2}}$ = arterial nitrogen tension (assumed equal to inspired tension in the E-E Model only)

$P_{T_{i_{N_2}}}$ = initial tissue nitrogen tension

K = halftine tissue exponential time constant

T = time at current depth (2 sec for this algorithm)

The tissue time constant K is more conveniently expressed in terms of the halftine $T_{1/2}$ where $T_{1/2} = (\ln 2)/K$. All tissues in this report will be described in terms of their halftimes instead of their time constants.

Equation 1 describes gas exchange for a period of time T over which no depth change occurs. If depth is not changing, the value of P computed by iterating Equation 1 every two seconds will be subjected only to a computer roundoff error. If Equation 1 is executed during depth changes an additional error is accumulated because Equation 1 approximates depth changes as a "staircase" with an instantaneous depth change followed by a 2 second pause. The maximum error from both sources over a 24 hour period would be ± 2 FSW. A detailed error analysis is given in Appendix B.

For the E-E Model, 9 halftime tissues with halftimes of 5, 10, 20, 40, 80, 120, 160, 200 and 240 min were used. Thus, each time the algorithm is run, Equation 1 is executed up to 9 times, once for each halftime tissue.

The E-L Model uses Equation 1 for gas uptake with the exception that $P_{a_{N_2}}$ the arterial inert gas tension, is not equal to inspired inert gas tension. Rather, the value of arterial inert gas tension in the E-L Model is computed from the formula:

$$(2) \quad P_{a_{N_2}} = P_{AMB} - P_{I_{O_2}} - 1.5$$

where:

$P_{a_{N_2}}$ = arterial inert gas tension

P_{AMB} = absolute ambient hydrostatic pressure

$P_{I_{O_2}}$ = inspired oxygen tension in FSW

1.5 = arterial CO_2 tension in FSW (35 mmHg)

Note that water vapor has been ignored. (Equation 9-A, Appendix A).

All gas tensions are expressed in terms of feet of seawater (FSW) where 33 FSW = 1 ATA = 760 mmHg. By using units of FSW, the mathematics of the algorithm is greatly simplified.

In the E-L Model, Equation 1 is used to describe gas uptake during tissue saturation. Saturation occurs if the tissue inert gas tension is less than arterial and desaturation occurs for the opposite condition. If at any time during desaturation the total gas tension in the theoretical halftime tissue exceeds ambient hydrostatic pressure offgassing will no longer be described by Equation 1 but instead will be described by the equation:

$$(3) \quad P_{T_{N_2}} = P_{T_{I_{N_2}}} + [2.8 - P_{I_{O_2}}] \cdot K \cdot T$$

where:

K = halftime tissue exponential time constant $(LN(2)/T_{1/2})$

2.8 = sum of venous O_2 and CO_2 tension minus arterial CO_2 tension in FSW

$[P_{V_{O_2}} (46 \text{ mmHg}) + P_{V_{CO_2}} (53 \text{ mmHg}) - P_{a_{CO_2}} (35 \text{ mmHg}) = 64 \text{ mmHg}]$

Thus, Equation 3 will be used instead of Equation 1 in the E-L Model when:

$$(4) \quad P_{Ti_{N_2}} + 4.3 > P_{AMB}$$

OR

$$(5) \quad P_{Ti_{N_2}} > P_{AMB} - 4.3$$

where:

4.3 = sum of tissue CO₂ and O₂ tensions in FSW (99 mmHg)
(tissue and mixed venous gas tensions are assumed equal)

The values for venous oxygen and carbon dioxide tension and arterial carbon dioxide tension used here are mean values based on those assumed by Van Liew in his investigations of tissue gas pocket resolution (16). These individual variables were included in the original derivation of the E-L Model for future expansion but are assumed constant in the E-L Model as tested here. In Appendix D, the VVAL18 ascent criteria table (page D-4) shows the value of the blood gas tensions (PaCO₂, PvCO₂ and PvO₂) in FSW which are assumed constant. The other blood parameters (PH₂O, AMBO₂ and PBOVP) were included for future expansion but are currently set to a value of 0 (5). The computed decompression schedules will be changed if different values for those variables are used but there is at present no basis for doing this. Thus, for now, these values should be considered arbitrary constants. The final version of the decompression model resulting from this study will have been "calibrated" to the values for these variables shown in this report.

Ascent Criteria

The part of the algorithm discussed so far only concerns itself with updating of all the tissue inert gas tensions. Thus, after any given update the tissue tensions reflect the cumulative gas tension up to that time in the dive. Decompression is regulated by setting limits on what maximum tissue inert gas tensions can be tolerated at any given depth without causing decompression sickness. The Maximum Permissible Tissue Tension (MPTT) values are used to compute the shallowest depth which could be ascended to after the tissue inert gas tensions have been updated.

Various sets of MPTT's were used in the course of this dive series and are contained in Tables 1 through 7. In this report, Ascent Criteria will refer to the values in these tables by name, i.e. MVAL5, MVAL83, MVAL93, MVAL97 and VVAL09, VVAL14 and VVAL18. The very first row of MPTT's of Tables 1 through 7 represent the maximum inert gas tension in units of FSW which can be present at 10 FSW before instantaneous ascent to the surface is allowed. These are known as the surfacing MPTT's and determine what the no-decompression limits will be. The next row (20 FSW) are the maximum values at 20 FSW which will allow instantaneous ascent to 10 FSW, the 30 FSW row contains the maximum values at 30 FSW which will allow instantaneous ascent to 20 FSW, and so on. Thus, the depth labeling each row of MPTT's indicates a depth 10 FSW deeper than the shallowest depth allowed providing all tissue tensions are less than their MPTT. If all MPTT's are less than the 10 FSW row values, it is safe to be at the surface. If all MPTT's are less than the 20 FSW row it is safe to be at 10 FSW and so on. The method used for computing

TABLE I

TABLE OF MAXIMUM PERMISSIBLE TISSUE TENSIONS

(MVALS - NITROGEN)

DEPTH	TISSUE HALF-TIMES									
	5 MIN 1.00 SDR	10 MIN 1.00 SDR	20 MIN 1.00 SDR	40 MIN 1.00 SDR	80 MIN 1.00 SDR	120 MIN 1.00 SDR	160 MIN 1.00 SDR	200 MIN 1.00 SDR	240 MIN 1.00 SDR	240 MIN 1.00 SDR
10 FSU	50.000	50.000	50.000	50.000	50.000	50.000	50.000	50.000	50.000	50.000
20 FSU	62.463	62.463	62.463	62.463	62.463	62.463	62.463	62.463	62.463	62.463
30 FSU	74.988	74.988	74.988	74.988	74.988	74.988	74.988	74.988	74.988	74.988
40 FSU	87.543	87.543	87.543	87.543	87.543	87.543	87.543	87.543	87.543	87.543
50 FSU	100.105	100.105	100.105	100.105	100.105	100.105	100.105	100.105	100.105	100.105
60 FSU	112.655	112.655	112.655	112.655	112.655	112.655	112.655	112.655	112.655	112.655
70 FSU	125.180	125.180	125.180	125.180	125.180	125.180	125.180	125.180	125.180	125.180
80 FSU	137.669	137.669	137.669	137.669	137.669	137.669	137.669	137.669	137.669	137.669
90 FSU	150.117	150.117	150.117	150.117	150.117	150.117	150.117	150.117	150.117	150.117
100 FSU	156.895	156.895	156.895	156.895	156.895	156.895	156.895	156.895	156.895	156.895
110 FSU	167.245	167.245	167.245	167.245	167.245	167.245	167.245	167.245	167.245	167.245
120 FSU	177.595	177.595	177.595	177.595	177.595	177.595	177.595	177.595	177.595	177.595
130 FSU	187.945	187.945	187.945	187.945	187.945	187.945	187.945	187.945	187.945	187.945
140 FSU	198.295	198.295	198.295	198.295	198.295	198.295	198.295	198.295	198.295	198.295
150 FSU	208.645	208.645	208.645	208.645	208.645	208.645	208.645	208.645	208.645	208.645
160 FSU	218.995	218.995	218.995	218.995	218.995	218.995	218.995	218.995	218.995	218.995
170 FSU	229.345	229.345	229.345	229.345	229.345	229.345	229.345	229.345	229.345	229.345
180 FSU	239.695	239.695	239.695	239.695	239.695	239.695	239.695	239.695	239.695	239.695
190 FSU	250.045	250.045	250.045	250.045	250.045	250.045	250.045	250.045	250.045	250.045
200 FSU	260.395	260.395	260.395	260.395	260.395	260.395	260.395	260.395	260.395	260.395
210 FSU	270.745	270.745	270.745	270.745	270.745	270.745	270.745	270.745	270.745	270.745
220 FSU	281.095	281.095	281.095	281.095	281.095	281.095	281.095	281.095	281.095	281.095
230 FSU	291.445	291.445	291.445	291.445	291.445	291.445	291.445	291.445	291.445	291.445
240 FSU	301.795	301.795	301.795	301.795	301.795	301.795	301.795	301.795	301.795	301.795
250 FSU	312.145	312.145	312.145	312.145	312.145	312.145	312.145	312.145	312.145	312.145
260 FSU	322.495	322.495	322.495	322.495	322.495	322.495	322.495	322.495	322.495	322.495
270 FSU	332.845	332.845	332.845	332.845	332.845	332.845	332.845	332.845	332.845	332.845
280 FSU	343.195	343.195	343.195	343.195	343.195	343.195	343.195	343.195	343.195	343.195
290 FSU	353.545	353.545	353.545	353.545	353.545	353.545	353.545	353.545	353.545	353.545
300 FSU	363.895	363.895	363.895	363.895	363.895	363.895	363.895	363.895	363.895	363.895

* - Maximum Tissue Tension which actually controlled stops on Phase I Test Profiles.

TABLE 2

TABLE OF MAXIMUM PERMISSIBLE TISSUE TENSIONS

(MVAL83- NITROGEN)

TISSUE HALF-TIMES

DEPTH	5 MIN	10 MIN	20 MIN	40 MIN	60 MIN	120 MIN	160 MIN	200 MIN	240 MIN
	1.00 SDR	1.00 SDR	1.00 SDR	1.00 SDR	1.00 SDR	1.00 SDR	1.00 SDR	1.00 SDR	1.00 SDR
10 FSU	103.000	85.000	71.000	57.000	46.740	46.740	46.740	46.740	46.740
20 FSU	104.933	85.850	73.000	61.480	61.480	61.480	61.480	61.480	61.480
30 FSU	106.866	86.700	74.988	74.988	74.988	74.988	74.988	74.988	74.988
40 FSU	108.799	87.543	87.543	87.543	87.543	87.543	87.543	87.543	87.543
50 FSU	110.720	100.105	100.105	100.105	100.105	100.105	100.105	100.105	100.105
60 FSU	112.655	112.655	112.655	112.655	112.655	112.655	112.655	112.655	112.655
70 FSU	125.180	125.180	125.180	125.180	125.180	125.180	125.180	125.180	125.180
80 FSU	137.669	137.669	137.669	137.669	137.669	137.669	137.669	137.669	137.669
90 FSU	150.117	150.117	150.117	150.117	150.117	150.117	150.117	150.117	150.117
100 FSU	156.895	156.895	156.895	156.895	156.895	156.895	156.895	156.895	156.895
110 FSU	167.245	167.245	167.245	167.245	167.245	167.245	167.245	167.245	167.245
120 FSU	177.595	177.595	177.595	177.595	177.595	177.595	177.595	177.595	177.595
130 FSU	187.945	187.945	187.945	187.945	187.945	187.945	187.945	187.945	187.945
140 FSU	198.295	198.295	198.295	198.295	198.295	198.295	198.295	198.295	198.295
150 FSU	208.645	208.645	208.645	208.645	208.645	208.645	208.645	208.645	208.645
160 FSU	218.995	218.995	218.995	218.995	218.995	218.995	218.995	218.995	218.995
170 FSU	229.345	229.345	229.345	229.345	229.345	229.345	229.345	229.345	229.345
180 FSU	239.695	239.695	239.695	239.695	239.695	239.695	239.695	239.695	239.695
190 FSU	250.045	250.045	250.045	250.045	250.045	250.045	250.045	250.045	250.045
200 FSU	260.395	260.395	260.395	260.395	260.395	260.395	260.395	260.395	260.395
210 FSU	270.745	270.745	270.745	270.745	270.745	270.745	270.745	270.745	270.745
220 FSU	281.095	281.095	281.095	281.095	281.095	281.095	281.095	281.095	281.095
230 FSU	291.445	291.445	291.445	291.445	291.445	291.445	291.445	291.445	291.445
240 FSU	301.795	301.795	301.795	301.795	301.795	301.795	301.795	301.795	301.795
250 FSU	312.145	312.145	312.145	312.145	312.145	312.145	312.145	312.145	312.145
260 FSU	322.495	322.495	322.495	322.495	322.495	322.495	322.495	322.495	322.495
270 FSU	332.845	332.845	332.845	332.845	332.845	332.845	332.845	332.845	332.845
280 FSU	343.195	343.195	343.195	343.195	343.195	343.195	343.195	343.195	343.195
290 FSU	353.545	353.545	353.545	353.545	353.545	353.545	353.545	353.545	353.545
300 FSU	363.895	363.895	363.895	363.895	363.895	363.895	363.895	363.895	363.895

TABLE 3

TABLE OF MAXIMUM PERMISSIBLE TISSUE TENSIONS

 (NVAL92- NITROGEN)

DEPTH	TISSUE HALF-TIMES									
	5 MIN 1.00 SDR	10 MIN 1.00 SDR	20 MIN 1.00 SDR	40 MIN 1.00 SDR	60 MIN 1.00 SDR	120 MIN 1.00 SDR	160 MIN 1.00 SDR	200 MIN 1.00 SDR	240 MIN 1.00 SDR	
10 FSU	103.000	85.000	71.000	56.000	46.740	43.000	40.500	40.500	40.500	
20 FSU	104.933	85.050	73.000	61.400	55.000	51.000	51.000	51.000	51.000	
30 FSU	106.860	86.700	74.900	74.900	74.900	74.900	74.900	74.900	74.900	
40 FSU	108.790	87.543	87.543	87.543	87.543	87.543	87.543	87.543	87.543	
50 FSU	110.720	100.105	100.105	100.105	100.105	100.105	100.105	100.105	100.105	
60 FSU	112.655	112.655	112.655	112.655	112.655	112.655	112.655	112.655	112.655	
70 FSU	125.100	125.100	125.100	125.100	125.100	125.100	125.100	125.100	125.100	
80 FSU	137.669	137.669	137.669	137.669	137.669	137.669	137.669	137.669	137.669	
90 FSU	150.117	150.117	150.117	150.117	150.117	150.117	150.117	150.117	150.117	
100 FSU	156.895	156.895	156.895	156.895	156.895	156.895	156.895	156.895	156.895	
110 FSU	167.245	167.245	167.245	167.245	167.245	167.245	167.245	167.245	167.245	
120 FSU	177.595	177.595	177.595	177.595	177.595	177.595	177.595	177.595	177.595	
130 FSU	187.945	187.945	187.945	187.945	187.945	187.945	187.945	187.945	187.945	
140 FSU	198.295	198.295	198.295	198.295	198.295	198.295	198.295	198.295	198.295	
150 FSU	208.645	208.645	208.645	208.645	208.645	208.645	208.645	208.645	208.645	
160 FSU	218.995	218.995	218.995	218.995	218.995	218.995	218.995	218.995	218.995	
170 FSU	229.345	229.345	229.345	229.345	229.345	229.345	229.345	229.345	229.345	
180 FSU	239.695	239.695	239.695	239.695	239.695	239.695	239.695	239.695	239.695	
190 FSU	250.045	250.045	250.045	250.045	250.045	250.045	250.045	250.045	250.045	
200 FSU	260.395	260.395	260.395	260.395	260.395	260.395	260.395	260.395	260.395	
210 FSU	270.745	270.745	270.745	270.745	270.745	270.745	270.745	270.745	270.745	
220 FSU	281.095	281.095	281.095	281.095	281.095	281.095	281.095	281.095	281.095	
230 FSU	291.445	291.445	291.445	291.445	291.445	291.445	291.445	291.445	291.445	
240 FSU	301.795	301.795	301.795	301.795	301.795	301.795	301.795	301.795	301.795	
250 FSU	312.145	312.145	312.145	312.145	312.145	312.145	312.145	312.145	312.145	
260 FSU	322.495	322.495	322.495	322.495	322.495	322.495	322.495	322.495	322.495	
270 FSU	332.845	332.845	332.845	332.845	332.845	332.845	332.845	332.845	332.845	
280 FSU	343.195	343.195	343.195	343.195	343.195	343.195	343.195	343.195	343.195	
290 FSU	353.545	353.545	353.545	353.545	353.545	353.545	353.545	353.545	353.545	
300 FSU	363.895	363.895	363.895	363.895	363.895	363.895	363.895	363.895	363.895	

TABLE 4

TABLE OF MAXIMUM PERMISSIBLE TISSUE TENSIONS
 (HYAL97- NITROGEN)

DEPTH	TISSUE HALF-TIMES								
	5 MIN 1.00 SDR	10 MIN 1.00 SDR	20 MIN 1.00 SDR	40 MIN 1.00 SDR	80 MIN 1.00 SDR	120 MIN 1.00 SDR	160 MIN 1.00 SDR	200 MIN 1.00 SDR	240 MIN 1.00 SDR
10 FSU	103.000	85.000	71.000	56.000	46.000	46.000	46.000	45.000	45.000
20 FSU	104.933	85.850	73.000	62.500	61.500	57.000	55.001	52.500	51.000
30 FSU	106.860	86.700	74.988	74.988	74.988	74.988	74.988	74.988	74.988
40 FSU	108.790	87.543	87.543	87.543	87.543	87.543	87.543	87.543	87.543
50 FSU	110.720	100.105	100.105	100.105	100.105	100.105	100.105	100.105	100.105
60 FSU	112.655	112.655	112.655	112.655	112.655	112.655	112.655	112.655	112.655
70 FSU	125.180	125.180	125.180	125.180	125.180	125.180	125.180	125.180	125.180
80 FSU	137.669	137.669	137.669	137.669	137.669	137.669	137.669	137.669	137.669
90 FSU	150.117	150.117	150.117	150.117	150.117	150.117	150.117	150.117	150.117
100 FSU	156.895	156.895	156.895	156.895	156.895	156.895	156.895	156.895	156.895
110 FSU	167.245	167.245	167.245	167.245	167.245	167.245	167.245	167.245	167.245
120 FSU	177.595	177.595	177.595	177.595	177.595	177.595	177.595	177.595	177.595
130 FSU	187.945	187.945	187.945	187.945	187.945	187.945	187.945	187.945	187.945
140 FSU	198.295	198.295	198.295	198.295	198.295	198.295	198.295	198.295	198.295
150 FSU	208.645	208.645	208.645	208.645	208.645	208.645	208.645	208.645	208.645
160 FSU	218.995	218.995	218.995	218.995	218.995	218.995	218.995	218.995	218.995
170 FSU	229.345	229.345	229.345	229.345	229.345	229.345	229.345	229.345	229.345
180 FSU	239.695	239.695	239.695	239.695	239.695	239.695	239.695	239.695	239.695
190 FSU	250.045	250.045	250.045	250.045	250.045	250.045	250.045	250.045	250.045
200 FSU	260.395	260.395	260.395	260.395	260.395	260.395	260.395	260.395	260.395
210 FSU	270.745	270.745	270.745	270.745	270.745	270.745	270.745	270.745	270.745
220 FSU	281.095	281.095	281.095	281.095	281.095	281.095	281.095	281.095	281.095
230 FSU	291.445	291.445	291.445	291.445	291.445	291.445	291.445	291.445	291.445
240 FSU	301.795	301.795	301.795	301.795	301.795	301.795	301.795	301.795	301.795
250 FSU	312.145	312.145	312.145	312.145	312.145	312.145	312.145	312.145	312.145
260 FSU	322.495	322.495	322.495	322.495	322.495	322.495	322.495	322.495	322.495
270 FSU	332.845	332.845	332.845	332.845	332.845	332.845	332.845	332.845	332.845
280 FSU	343.195	343.195	343.195	343.195	343.195	343.195	343.195	343.195	343.195
290 FSU	353.545	353.545	353.545	353.545	353.545	353.545	353.545	353.545	353.545
300 FSU	363.895	363.895	363.895	363.895	363.895	363.895	363.895	363.895	363.895

TABLE 5

TABLE OF MAXIMUM PERMISSIBLE TISSUE TENSIONS
 (VAL09- NITROGEN)

DEPTH	TISSUE HALF-TIMES								
	5 MIN 1.00 SDR	10 MIN 1.00 SDR	20 MIN 1.00 SDR	40 MIN 1.00 SDR	60 MIN 1.00 SDR	120 MIN 1.00 SDR	160 MIN 1.00 SDR	200 MIN 1.00 SDR	240 MIN 1.00 SDR
10 FSW	103.000	87.000	72.000	56.000	45.500	45.000	44.500	44.000	43.500
20 FSW	113.000	97.000	82.000	66.000	55.500	55.000	54.500	54.000	53.500
30 FSW	123.000	107.000	92.000	76.000	65.500	65.000	64.500	64.000	63.500
40 FSW	133.000	117.000	102.000	86.000	75.500	75.000	74.500	74.000	73.500
50 FSW	143.000	127.000	112.000	96.000	85.500	85.000	84.500	84.000	83.500
60 FSW	153.000	137.000	122.000	106.000	95.500	95.000	94.500	94.000	93.500
70 FSW	163.000	147.000	132.000	116.000	105.500	105.000	104.500	104.000	103.500
80 FSW	173.000	157.000	142.000	126.000	115.500	115.000	114.500	114.000	113.500
90 FSW	183.000	167.000	152.000	136.000	125.500	125.000	124.500	124.000	123.500
100 FSW	193.000	177.000	162.000	146.000	135.500	135.000	134.500	134.000	133.500
110 FSW	203.000	187.000	172.000	156.000	145.500	145.000	144.500	144.000	143.500
120 FSW	213.000	197.000	182.000	166.000	155.500	155.000	154.500	154.000	153.500
130 FSW	223.000	207.000	192.000	176.000	165.500	165.000	164.500	164.000	163.500
140 FSW	233.000	217.000	202.000	186.000	175.500	175.000	174.500	174.000	173.500
150 FSW	243.000	227.000	212.000	196.000	185.500	185.000	184.500	184.000	183.500
160 FSW	253.000	237.000	222.000	206.000	195.500	195.000	194.500	194.000	193.500
170 FSW	263.000	247.000	232.000	216.000	205.500	205.000	204.500	204.000	203.500
180 FSW	273.000	257.000	242.000	226.000	215.500	215.000	214.500	214.000	213.500
190 FSW	283.000	267.000	252.000	236.000	225.500	225.000	224.500	224.000	223.500
200 FSW	293.000	277.000	262.000	246.000	235.500	235.000	234.500	234.000	233.500
210 FSW	303.000	287.000	272.000	256.000	245.500	245.000	244.500	244.000	243.500
220 FSW	313.000	297.000	282.000	266.000	255.500	255.000	254.500	254.000	253.500
230 FSW	323.000	307.000	292.000	276.000	265.500	265.000	264.500	264.000	263.500
240 FSW	333.000	317.000	302.000	286.000	275.500	275.000	274.500	274.000	273.500
250 FSW	343.000	327.000	312.000	296.000	285.500	285.000	284.500	284.000	283.500
260 FSW	353.000	337.000	322.000	306.000	295.500	295.000	294.500	294.000	293.500
270 FSW	363.000	347.000	332.000	316.000	305.500	305.000	304.500	304.000	303.500
280 FSW	373.000	357.000	342.000	326.000	315.500	315.000	314.500	314.000	313.500
290 FSW	383.000	367.000	352.000	336.000	325.500	325.000	324.500	324.000	323.500
300 FSW	393.000	377.000	362.000	346.000	335.500	335.000	334.500	334.000	333.500

TABLE 6

TABLE OF MAXIMUM PERMISSIBLE TISSUE TENSIONS

(VVAL14- NITROGEN)

DEPTH	TISSUE HALF-TIMES								
	5 MIN 1.00 SDR	10 MIN 1.00 SDR	20 MIN 1.00 SDR	40 MIN 1.00 SDR	80 MIN 1.00 SDR	120 MIN 1.00 SDR	160 MIN 1.00 SDR	200 MIN 1.00 SDR	240 MIN 1.00 SDR
10 FSW	120.000	98.000	78.000	58.000	48.500	45.500	44.500	44.000	43.500
20 FSW	130.000	109.000	88.000	68.000	58.500	55.500	54.500	54.000	53.500
30 FSW	140.000	118.000	98.000	78.000	68.500	65.500	64.500	64.000	63.500
40 FSW	150.000	128.000	108.000	88.000	78.500	75.500	74.500	74.000	73.500
50 FSW	160.000	138.000	118.000	98.000	88.500	85.500	84.500	84.000	83.500
60 FSW	170.000	148.000	128.000	108.000	98.500	95.500	94.500	94.000	93.500
70 FSW	180.000	158.000	138.000	118.000	108.500	105.500	104.500	104.000	103.500
80 FSW	190.000	168.000	148.000	128.000	118.500	115.500	114.500	114.000	113.500
90 FSW	200.000	178.000	158.000	138.000	128.500	125.500	124.500	124.000	123.500
100 FSW	210.000	188.000	168.000	148.000	138.500	135.500	134.500	134.000	133.500
110 FSW	220.000	198.000	178.000	158.000	148.500	145.500	144.500	144.000	143.500
120 FSW	230.000	208.000	188.000	168.000	158.500	155.500	154.500	154.000	153.500
130 FSW	240.000	218.000	198.000	178.000	168.500	165.500	164.500	164.000	163.500
140 FSW	250.000	228.000	208.000	188.000	178.500	175.500	174.500	174.000	173.500
150 FSW	260.000	238.000	218.000	198.000	188.500	185.500	184.500	184.000	183.500
160 FSW	270.000	248.000	228.000	208.000	198.500	195.500	194.500	194.000	193.500
170 FSW	280.000	258.000	238.000	218.000	208.500	205.500	204.500	204.000	203.500
180 FSW	290.000	268.000	248.000	228.000	218.500	215.500	214.500	214.000	213.500
190 FSW	300.000	278.000	258.000	238.000	228.500	225.500	224.500	224.000	223.500
200 FSW	310.000	288.000	268.000	248.000	238.500	235.500	234.500	234.000	233.500
210 FSW	320.000	298.000	278.000	258.000	248.500	245.500	244.500	244.000	243.500
220 FSW	330.000	308.000	288.000	268.000	258.500	255.500	254.500	254.000	253.500
230 FSW	340.000	318.000	298.000	278.000	268.500	265.500	264.500	264.000	263.500
240 FSW	350.000	328.000	308.000	288.000	278.500	275.500	274.500	274.000	273.500
250 FSW	360.000	338.000	318.000	298.000	288.500	285.500	284.500	284.000	283.500
260 FSW	370.000	348.000	328.000	308.000	298.500	295.500	294.500	294.000	293.500
270 FSW	380.000	358.000	338.000	318.000	308.500	305.500	304.500	304.000	303.500
280 FSW	390.000	368.000	348.000	328.000	318.500	315.500	314.500	314.000	313.500
290 FSW	400.000	378.000	358.000	338.000	328.500	325.500	324.500	324.000	323.500
300 FSW	410.000	388.000	368.000	348.000	338.500	335.500	334.500	334.000	333.500

TABLE 7

TABLE OF MAXIMUM PERMISSIBLE TISSUE TENSIONS

(VVAL18- NITROGEN)

Stops in feet	TISSUE HALF-TIMES								Tensions in FSW	
	5 MIN 1.00 SDR	10 MIN 1.00 SDR	20 MIN 1.00 SDR	40 MIN 1.00 SDR	80 MIN 1.00 SDR	120 MIN 1.00 SDR	160 MIN 1.00 SDR	200 MIN 1.00 SDR	240 MIN 1.00 SDR	
10 FSU	120.000	98.000	78.000	56.000	48.500	45.500	44.500	44.000	43.500	
20 FSU	130.000	108.000	88.000	66.000	58.500	55.500	54.500	54.000	53.500	
30 FSU	140.000	118.000	98.000	76.000	68.500	65.500	64.500	64.000	63.500	
40 FSU	150.000	128.000	108.000	86.000	78.500	75.500	74.500	74.000	73.500	
50 FSU	160.000	138.000	118.000	96.000	88.500	85.500	84.500	84.000	83.500	
60 FSU	170.000	148.000	128.000	106.000	98.500	95.500	94.500	94.000	93.500	
70 FSU	180.000	158.000	138.000	116.000	108.500	105.500	104.500	104.000	103.500	
80 FSU	190.000	168.000	148.000	126.000	118.500	115.500	114.500	114.000	113.500	
90 FSU	200.000	178.000	158.000	136.000	128.500	125.500	124.500	124.000	123.500	
100 FSU	210.000	188.000	168.000	146.000	138.500	135.500	134.500	134.000	133.500	
110 FSU	220.000	198.000	178.000	156.000	148.500	145.500	144.500	144.000	143.500	
120 FSU	230.000	208.000	188.000	166.000	158.500	155.500	154.500	154.000	153.500	
130 FSU	240.000	218.000	198.000	176.000	168.500	165.500	164.500	164.000	163.500	
140 FSU	250.000	228.000	208.000	186.000	178.500	175.500	174.500	174.000	173.500	
150 FSU	260.000	238.000	218.000	196.000	188.500	185.500	184.500	184.000	183.500	
160 FSU	270.000	248.000	228.000	206.000	198.500	195.500	194.500	194.000	193.500	
170 FSU	280.000	258.000	238.000	216.000	208.500	205.500	204.500	204.000	203.500	
180 FSU	290.000	268.000	248.000	226.000	218.500	215.500	214.500	214.000	213.500	
190 FSU	300.000	278.000	258.000	236.000	228.500	225.500	224.500	224.000	223.500	
200 FSU	310.000	288.000	268.000	246.000	238.500	235.500	234.500	234.000	233.500	
210 FSU	320.000	298.000	278.000	256.000	248.500	245.500	244.500	244.000	243.500	
220 FSU	330.000	308.000	288.000	266.000	258.500	255.500	254.500	254.000	253.500	
230 FSU	340.000	318.000	298.000	276.000	268.500	265.500	264.500	264.000	263.500	
240 FSU	350.000	328.000	308.000	286.000	278.500	275.500	274.500	274.000	273.500	
250 FSU	360.000	338.000	318.000	296.000	288.500	285.500	284.500	284.000	283.500	
260 FSU	370.000	348.000	328.000	306.000	298.500	295.500	294.500	294.000	293.500	
270 FSU	380.000	358.000	338.000	316.000	308.500	305.500	304.500	304.000	303.500	
280 FSU	390.000	368.000	348.000	326.000	318.500	315.500	314.500	314.000	313.500	
290 FSU	400.000	378.000	358.000	336.000	328.500	325.500	324.500	324.000	323.500	
300 FSU	410.000	388.000	368.000	346.000	338.500	335.500	334.500	334.000	333.500	

Stops in meters	Tensions in FSW									
	5 MIN 1.00 SDR	10 MIN 1.00 SDR	20 MIN 1.00 SDR	40 MIN 1.00 SDR	80 MIN 1.00 SDR	120 MIN 1.00 SDR	160 MIN 1.00 SDR	200 MIN 1.00 SDR	240 MIN 1.00 SDR	
3 MSU	120.000	98.000	78.000	56.000	48.500	45.500	44.500	44.000	43.500	
6 MSU	129.843	107.843	87.843	65.843	58.343	55.343	54.343	53.843	53.343	
9 MSU	139.685	117.685	97.685	75.685	68.185	65.185	64.185	63.685	63.185	
12 MSU	149.528	127.528	107.528	85.528	78.028	75.028	74.028	73.528	73.028	
15 MSU	159.370	137.370	117.370	95.370	87.870	84.870	83.870	83.370	82.870	
18 MSU	169.213	147.213	127.213	105.213	97.713	94.713	93.713	93.213	92.713	
21 MSU	179.055	157.055	137.055	115.055	107.555	104.555	103.555	103.055	102.555	
24 MSU	188.898	166.898	146.898	124.898	117.398	114.398	113.398	112.898	112.398	
27 MSU	198.740	176.740	156.740	134.740	127.240	124.240	123.240	122.740	122.240	
30 MSU	208.583	186.583	166.583	144.583	137.083	134.083	133.083	132.583	132.083	
33 MSU	218.425	196.425	176.425	154.425	146.925	143.925	142.925	142.425	141.925	
36 MSU	228.268	206.268	186.268	164.268	156.768	153.768	152.768	152.268	151.768	
39 MSU	238.110	216.110	196.110	174.110	166.610	163.610	162.610	162.110	161.610	
42 MSU	247.953	225.953	205.953	183.953	176.453	173.453	172.453	171.953	171.453	
45 MSU	257.795	235.795	215.795	193.795	186.295	183.295	182.295	181.795	181.295	
48 MSU	267.638	245.638	225.638	203.638	196.138	193.138	192.138	191.638	191.138	
51 MSU	277.480	255.480	235.480	213.480	205.980	202.980	201.980	201.480	200.980	
54 MSU	287.323	265.323	245.323	223.323	215.823	212.823	211.823	211.323	210.823	
57 MSU	297.166	275.166	255.166	233.166	225.666	222.666	221.666	221.166	220.666	
60 MSU	307.008	285.008	265.008	243.008	235.508	232.508	231.508	231.008	230.508	
63 MSU	316.851	294.851	274.851	252.851	245.351	242.351	241.351	240.851	240.351	
66 MSU	326.693	304.693	284.693	262.693	255.193	252.193	251.193	250.693	250.193	
69 MSU	336.536	314.536	294.536	272.536	265.036	262.036	261.036	260.536	260.036	
72 MSU	346.378	324.378	304.378	282.378	274.878	271.878	270.878	270.378	269.878	
75 MSU	356.221	334.221	314.221	292.221	284.721	281.721	280.721	280.221	279.721	
78 MSU	366.063	344.063	324.063	302.063	294.563	291.563	290.563	290.063	289.563	
81 MSU	375.906	353.906	333.906	311.906	304.406	301.406	300.406	299.906	299.406	
84 MSU	385.748	363.748	343.748	321.748	314.248	311.248	310.248	309.748	309.248	
87 MSU	395.591	373.591	353.591	331.591	324.091	321.091	320.091	319.591	319.091	
90 MSU	405.433	383.433	363.433	341.433	333.933	330.933	329.933	329.433	328.933	

the MPTT's of the various ascent criteria is described in reference 5 and their significance will be discussed later.

Warning Status

As Phase I testing of the MK 15/16 RTA progressed, it became apparent that its safety could not be guaranteed outside of a certain depth/time domain. The MK 15/16 RTA uses the 40 minute tissue inert gas tension to determine when the diver has gone outside of the tested depth/time domain. The reason for choosing this tissue is discussed in reference (1). Basically, when the 40 minute tissue tension exceeds 77 FSW the diver is warned to decompress to a depth of 30 FSW or shallower. He must then remain at that depth until the 40 minute tissue tension has decreased to a value of less than 48 FSW. As currently envisioned for the UDC, the warning is conveyed to the diver by flashing the SAD display. When the warning is activated, the diver would decompress to a depth of 30 FSW or shallower and remain there until the 40 min tissue tension falls to at least 48 FSW. Once the 40 min halftime tissue tension has decreased to less than 48 FSW, the warning is inactivated and the diver may descend below 30 FSW until the 40 min halftime tissue tension again exceeds a value of 77 FSW.

It must be realized that the warning is not part of the Decompression Model used to construct the MK 15/16 RTA and in no way interferes with computation of decompression profiles. Its only purpose is to keep the diver within the depth/time domain in which the MK 15/16 RTA was tested. While the algorithm will compute tables outside of the tested depth/time domain (even if the warning is activated), the safety of these schedules has not yet been verified. As experience is gained the constraints placed on the algorithm may be relaxed and at some point will probably be eliminated altogether.

Computer Algorithms

The previous discussion concerning the decompression model so far has concerned itself with a general discussion of the components of the model. The components are brought together into a computer algorithm which can be used to compute the SAD every 2 seconds. It is the SAD which describes the decompression status of the diver at any given time. No attempt will be made to describe actual computer programs here since the MK 15/16 RTA can be implemented on systems varying from hand-held calculators to microcomputers to custom designed microprocessors and even main-frame units. Instead detailed flowcharts will be presented which would then be the basis of a program for any desired system.

Exponential-Exponential Model

Figure 3 shows the flowchart for the E-E Version of the MK 15/16 RTA. The values for the 9 tissue halftimes are contained in the array HLFTM. The subscript I in the variable HLFTM(I) assumes its lowest value of 1 for the

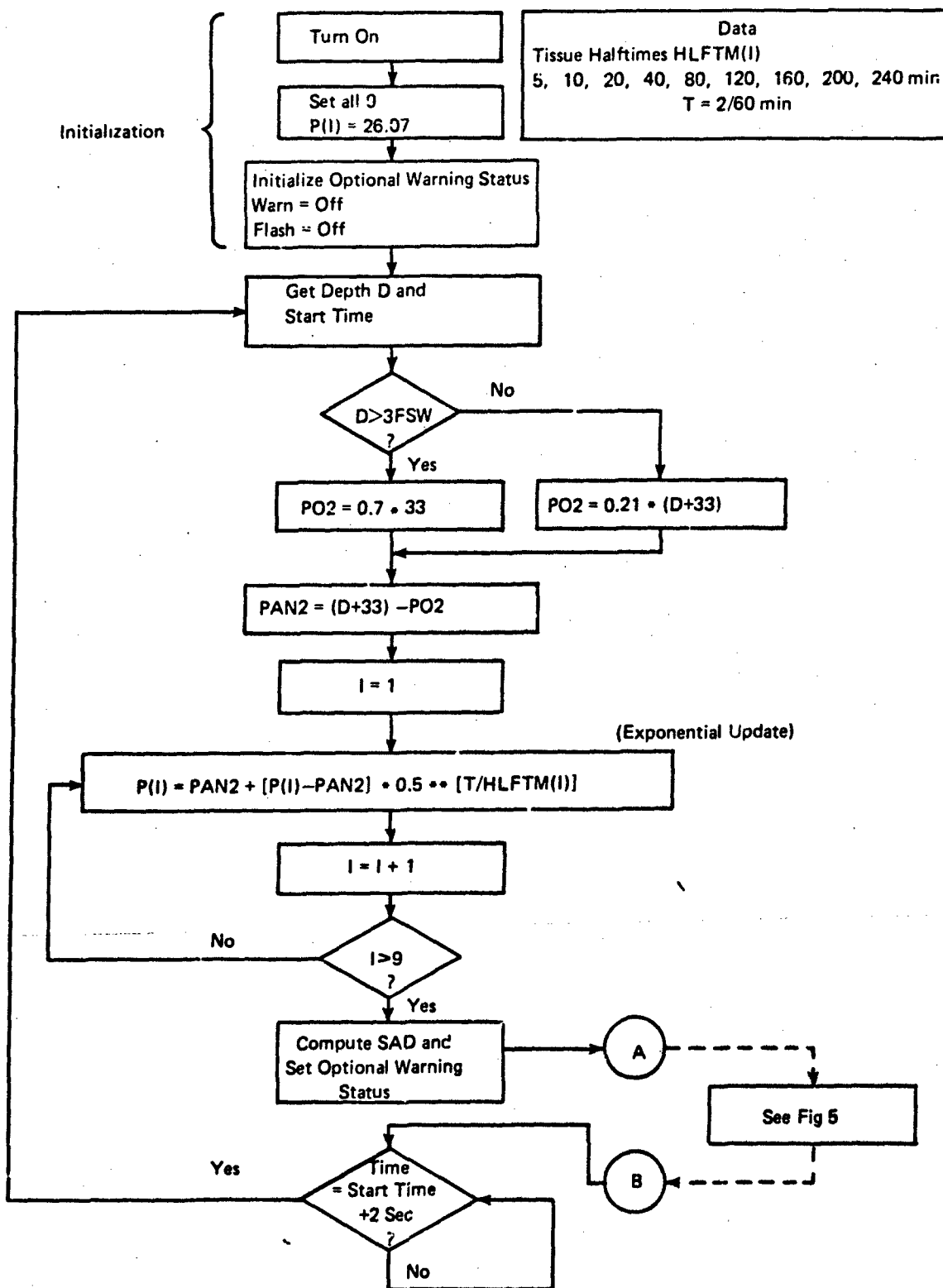

FIGURE 3. E-E ALGORITHM FLOWCHART. COMPUTATION OF SAFE ASCENT DEPTH AND DETERMINATION OF WARNING STATUS SHOWN IN FIGURE 5.

shortest halftime (5 min) and its largest value of 9 for the longest halftime (240 min). The MPTT's are contained in the double subscripted array M where the first subscript represents the row (depth) and the second subscript the column (tissue halftime). The time interval used for all tissue updates (T) is fixed at 2 sec. All 9 tissues are initialized to saturation at 1 ATA on air. This saturation value is $0.79 \cdot 33 = 26.07$ FSW. The algorithm gets the depth from a pressure transducer. If the depth is shallower than 3 FSW the oxygen tension is computed assuming that the diver is breathing air. If the depth is greater than 3 FSW the PO_2 is assumed to be a constant 0.7 ATA. Next, the ambient inert gas tension is computed and then the 9 tissue tensions are updated using Equation 1. (Note that $e^{-KT} = 0.5 T/T_{1/2}$). After all 9 tissues have been updated the SAD is computed and the warning status is determined. Then the algorithm waits until the remainder of the two seconds have elapsed since it started its computation then executes again.

Exponential-Linear Model

The flowchart for the E-L Model is shown in Figure 4. It is similar to the one for the E-E Model except that there are two gas update equations instead of one and the variable P_{AN2} (arterial inert gas tension) is computed according to Equation 2 and does not equal inspired inert gas tension. If the initial tissue tension is less than the ambient hydrostatic pressure minus 4.3 FSW (Equation 5), then that particular tissue is updated using the exponential update (Equation 1) and, if it is greater, then the linear update is used (Equation 3). Note that in Figure 4 the variable DPDT is first computed as the product $[2.8 - PIO_2] \cdot K$ and then used to evaluate Equation 3 as the second step in the linear update.

Safe Ascent Depth and Warning Status

Both the E-E Version and the E-L Version of the MK 15/16 RTA use the algorithm shown in Figure 5 to compute the SAD and set the warning. The algorithm compares the tissue tensions with the maximum permissible value in the array M starting at the depth of the deepest stop and working up. The subscript I denotes the MPTT for a particular halftime tissue, a value of 1 denoting the 5 min tissue and a value of 9 the 240 min tissue. It was determined that no decompression stops deeper than 100 FSW would occur over the operational depth range of the MK-15 using N_2-O_2 so only the maximum permissible tissue tensions down to this depth are used to save time and memory. If all 9 updated tissue tensions are less than or equal to their respective MPTT's at that depth, the tissue tensions are compared to the MPTT values at the next shallower depth increment. This continues until a depth is found where at least one tissue tension exceeds its maximum value. The depth at which this occurs is the SAD. If all tissue tensions are less than all MPTT values for all depths, the SAD is 0 FSW. The J subscript of array element M (I,J) determines the number of stop depth increments below the surface to which the MPTT's in that row apply. Since the stop depth increments are 10 FSW, the SAD is computed by multiplying the value of J (for the row where at least one tissue tension exceeds its MPTT) by 10. The depth and SAD are updated and displayed continuously.

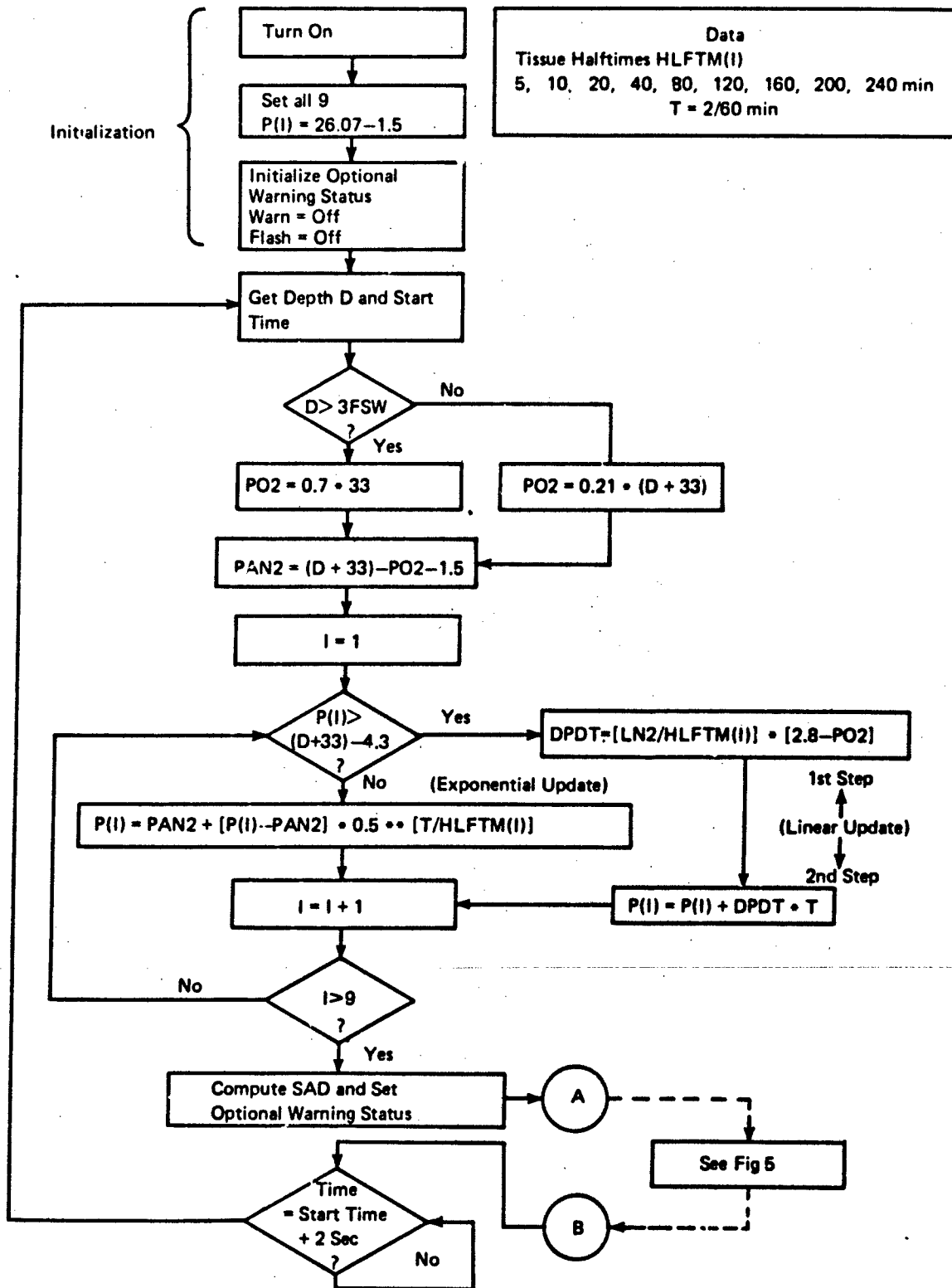
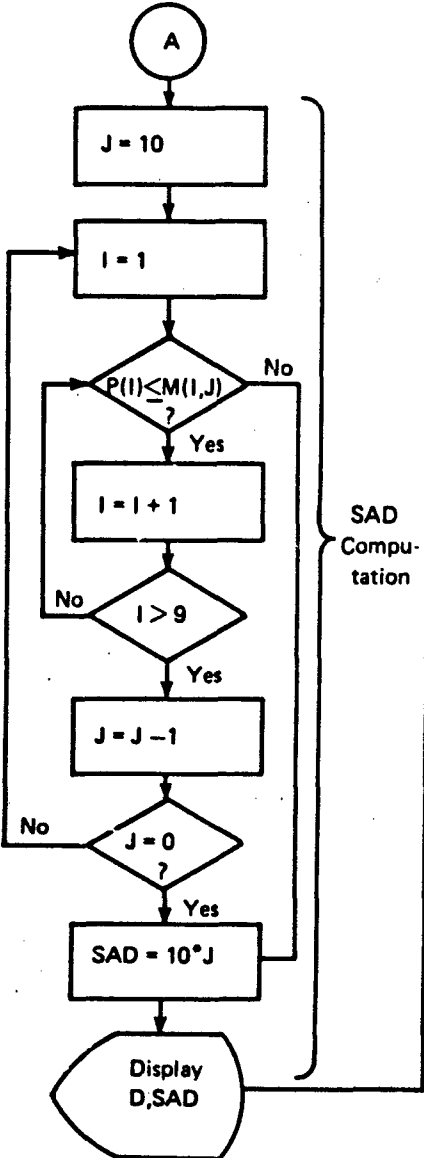

FIGURE 4. E-L ALGORITHM FLOWCHART. SAFE ASCENT DEPTH COMPUTATION AND DETERMINATION OF WARNING STATUS SHOWN IN FIGURE 5.

From Main Program
Fig 3 or Fig 4



SAD
Compu-
tation

DATA

Table of Maximum
Permissible Tissue Tensions

$M(I,J) (I=1,9 J=1,10)$

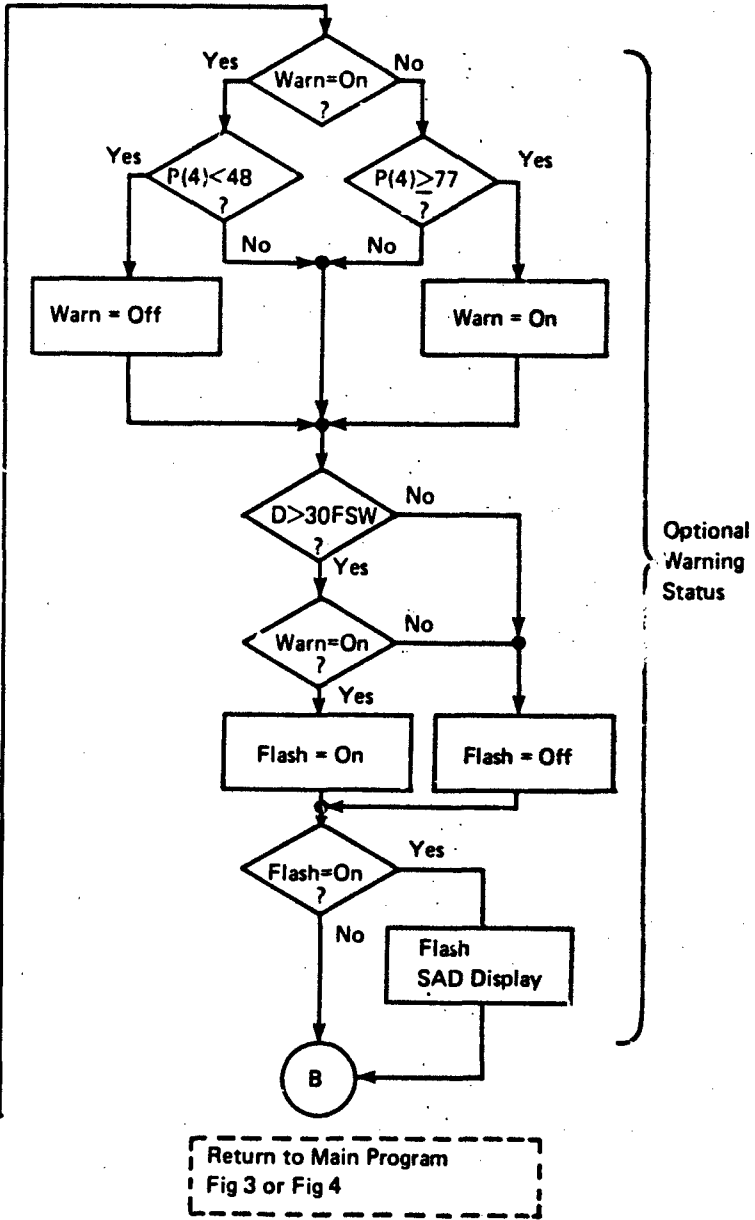

Optional
Warning
Status

Return to Main Program
Fig 3 or Fig 4

FIGURE 5. SAFE ASCENT DEPTH COMPUTATION AND WARNING STATUS DETERMINATION FLOWCHART THIS SCHEME USED FOR BOTH THE E-E MODEL (FIGURE 3) AND THE E-L MODEL (FIGURE 4).

Next, the warning is activated or deactivated depending on the value of the 40 minute halftime tissue tensions. The value of WARN (either ON or OFF) and the depth determine if the SAD display flashes. If WARN is OFF, the SAD display never flashes. If it is ON, the SAD display flashes only if the depth is greater than 30 FSW.

METHODS

All divers participating as test subjects in Phase II testing were qualified U.S. Navy and U.S. Army divers. Physical characteristics of the divers are given in Table 8. All divers were given thorough diving physical examinations before the dive series began and were examined immediately before and after each dive by a qualified U.S. Navy Diving Medical Officer. Divers were grouped into 2 teams; 10 divers being selected from a team for each dive. The dive schedule was arranged so that each subject usually had at least a 36 hour interval between dives. Divers all underwent two weeks of physical training before the beginning of the dive series and were all in good physical condition.

All divers were thoroughly trained in the use of the MK 15 closed circuit constant PO_2 UBA and all dives were done using the MK 15 UBA with the PO_2 setpoint adjusted to 0.7 ATA. A complete description of the MK 15 hardware and operating characteristics is given in references (2) and (3). The diluent used was air. With a PO_2 setpoint of 0.7 ATA, the MK 15 will maintain a mean PO_2 of 0.7 ATA with a minimum of 0.6 ATA and a maximum of 0.8 ATA in the breathing gas. This PO_2 range is maintained irrespective of depth. There is an alarm light that will warn a diver if his PO_2 falls to 0.6 ATA and if this happened he was instructed to manually add oxygen and to change to another UBA if PO_2 could not automatically be maintained in the 0.6-0.8 ATA range. As long as no alarm lights indicated a low PO_2 divers were instructed to let the UBA control automatically and no attempt was made to control the PO_2 at exactly 0.7 ATA. As will be seen later, this means that the tables resulting from this dive series could be used with any UBA which controls to a mean PO_2 of 0.7 ATA (or above) as long as it warns the diver when the PO_2 falls to 0.6 ATA or lower.

During surface intervals at 1 ATA the divers came off of their MK 15 UBA immediately upon exiting the water and began breathing air. They continued breathing air for the entire surface interval and went back on the MK 15 UBA immediately after re-entering the water for the repetitive dive.

All dives were conducted in the 15 foot diameter by 46 foot long wet chamber of the Ocean Simulation Facility (OSF) at NEDU in Panama City, Florida. Divers wore 1/4" full wetsuits consisting of "Farmer John" trousers, jacket, hood, gloves and boots. Water temperature was adjusted between 45°F to 65°F depending on the length of time in the water and was selected to chill the divers to the point of being uncomfortable without causing dive aborts. During their time at depth the 10 divers performed intermittent exercise at 50 watts on an electrically braked bicycle ergometer. Since only 5 bicycle ergometers were available, only half the divers were actually exercising at a given time. Exercise periods lasted 10 minutes at which time the 5

TABLE 8

Physical Characteristics of Divers

Diver #	Age	Height (in)	Weight (lbs)
1**	21	66	176
2*	20	70	176
3*	28	72	180
4**	24	68	153
5*	20	71	170
6*	28	72	200
7*	24	72	160
8*	36	72	190
9*	24	70	175
10	22	65	150
11	23	69	160
12	23	69	167
13	23	70	170
14	24	70	163
15	23	68	167
16	38	69	212
17	24	71	172
18	20	71	165
19	25	71	175
20	23	67	155
21	23	68	154
22	27	70	177
23	20	69	160
24	27	75	165
25	25	71	170
26	21	68	145
27	20	67	146
28	22	70	158
29	34	67	160
30	35	70	200
Mean	24.6	69.6	169.0
S.D.	4.5	2.1	15.8

*Each asterisk next to a diver number indicates one case of decompression sickness for that diver.

non-exercising divers mounted the ergometers and began exercising. This alternating 10 minute work, 10 minute rest cycle continued until 1 minute prior to decompression at which time all exercise stopped. The mean oxygen consumption for the alternating work/rest cycle was estimated as 1.00 l/min assuming a 1.48 l/min oxygen consumption during exercise and a 0.48 l/min oxygen consumption at rest (4). All divers remained at rest for the entire decompression. After decompression the divers immediately exited the wet chamber and removed their UBA's. If a repetitive dive was to follow, the divers ran 4 miles (at 8-9 minutes/mile) during selected surface intervals. If there were two repetitive dives following the initial dive, divers ran during both surface intervals. If there were three repetitive dives after the initial dive, divers ran during the first and third surface interval. The combination of severe thermal stress, exercise at depth, rest during decompression, and exercise during surface intervals were all designed to subject the divers to worst-case conditions throughout the profile and test the safety of the computer algorithm at its perceived limits.

All dives were done using a decompression schedule generated in real time by a Hewlett-Packard HP 1000 Series Computer. The computer continuously monitored chamber depth from an Ashcroft Digigauge to an accuracy of ± 1 FSW and updated the diver's decompression status every 2 seconds. Real time algorithms were developed as discussed earlier. Real time computation allowed any holds or changes in travel rate during ascent and/or descent to be taken into account thus producing a decompression schedule exactly suited to a particular dive profile. The decompression status was displayed on a CRT display as the shallowest depth which could be ascended to at any given time without violating the ascent criteria, the so-called Safe Ascent Depth (SAD). During decompression the divers' depth was matched to the SAD which was always computed in 10 FSW increments. The actual dive profiles were continuously recorded and stored by the computer and could be retrieved digitally or graphically after the dive. A typical dive profile plot is shown in Figure 6.

After entering the water, all divers switched from breathing air to the MK 15 and descended to the bottom of the wetpot in unison on signal from the Dive Supervisor, thus ensuring that computer updates regarding breathing gas changes and depth changes corresponded exactly to what the divers were doing in real time. Once at the bottom of the wetpot all divers were instructed to remain upright with their feet just touching the floor of the wetpot. Thus, non-exercising divers were within 1 FSW depth of each other. During exercise divers were at the most 1 FSW deeper at mid-chest than when standing. Thus, the assumed depth error over an entire dive was ± 1 FSW between divers.

Descent rates were 30-60 FSW/min depending on divers ability to clear their ears. In some cases there were holds on the way down followed by ascents because of eustachian tube blockage in some diver. Since the decompression schedules were all computed in real time all these holds were taken into account in determining actual decompression obligation. Ascent rates were 60 FSW/min to 20 FSW, 40 FSW/min to 10 FSW, and 30 FSW/min to the surface, these being the maximum OSF travel rates over these depth ranges.

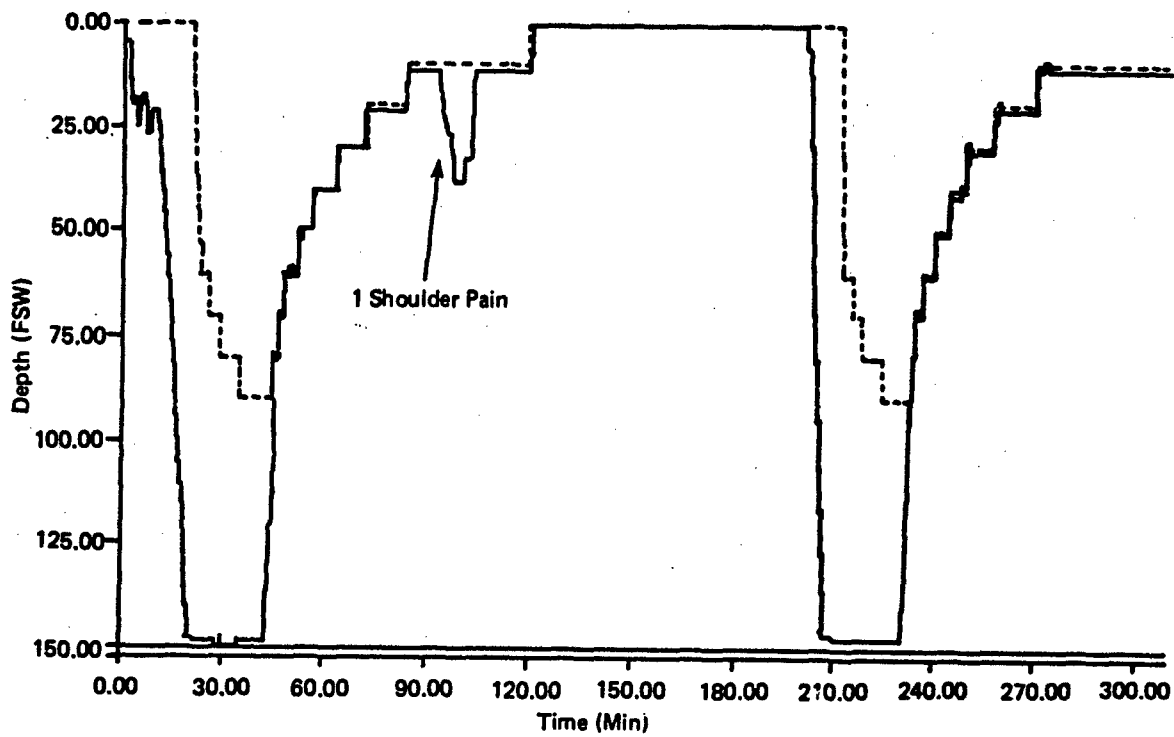

FIGURE 6. Typical Dive Profile. The solid line shows the actual depth profile while the dashed line shows the SAD as computed by the E-L Algorithm. Note the downward excursion during the 10 FSW stop of the first dive to treat shoulder pain (Table 11, f) in one subject.

Occasionally, a diver would have to come off of his UBA while at depth because of a rig malfunction and breathe chamber atmosphere for short periods of time. Chamber atmosphere was always air which could have a PO_2 considerably different from 0.7 ATA depending on depth. Therefore, if a diver had to breathe chamber atmosphere for more than a few minutes he was eliminated as a test subject from that particular dive. He would then breathe by mask a gas that was changed at various depths so its PO_2 was always much greater than 0.7 ATA to preclude any chance of decompression sickness developing (6). As previously mentioned, no effort was made to regulate PO_2 as long as the MK 15 was controlling the PO_2 normally, that is between 0.6 and 0.8 ATA with a mean of 0.7 ATA. If a diver found his PO_2 outside of this range, he first adjusted the PO_2 manually to 0.7 ATA. If the UBA still failed to properly control the PO_2 , the diver was immediately given another UBA.

The only criteria used to evaluate the safety of a particular dive profile was the occurrence of clinical decompression sickness. The determination as to whether or not a particular diver had decompression sickness was made by qualified U.S. Navy Diving Medical Officers who evaluated both subjective and objective signs and symptoms. If in the opinion of the examining Diving Medical Officer (based on diver history and physical examination) decompression sickness was present, then appropriate treatment was instituted. No other criteria (such as ultrasonic doppler monitoring) were used to determine whether or not decompression sickness was present. Usually symptoms of decompression sickness would not manifest themselves until the diver surfaced in which case only the stricken diver was treated. In some instances symptoms occurred while still at depth and when the stricken diver could not be isolated in another chamber all the other divers on that particular dive were treated along with the stricken diver. In these cases the asymptomatic divers were not included in the statistics at all while the stricken diver was counted as a case of decompression sickness.

Test Profiles

A total of 12 different test profiles were planned but of these only 9 were used in the course of this study. They were all of the multiple repetitive dive type with exercise during selected surface intervals and are presented in Table 9. These profiles were chosen mainly to investigate no-decompression limits from 40 to 150 FSW in 20 FSW increments and to retest areas with high DCS incidence from Phase I testing. The water temperature for each profile is also shown in Table 9. While only the 9 profiles shown in Table 9 were dove during Phase II testing, any changes made to the MK 15/16 RTA were checked against the test profiles used in Phase I testing to ensure that no shortening of decompression time occurred in any of those Phase I profiles which were not retested. This allowed previously gathered data to remain relevant to the present study and precluded a lot of retesting of profiles. While a large number of extra man-dives did not have to be done, some compromises resulted as will be discussed.

TABLE 9
Phase II Profiles

<u>Profile</u>	<u>Temp.</u> (°F)	<u>Depth/Time Combinations</u> (FSW)/(Min)
20	(55°)	60/ND → @0/80 → 60/ND → @0/80 → 60/ND*
21	(65°)	40/ND → @0/80 → 100/ND
22	(50°)	100/ND → @0/80 → 100/ND → 0/80 → 100/ND → @0/80 → 100/ND
23	(50°)	80/ND → @0/80 → 80/ND → 0/80 → 80/ND → @0/60 → 80/ND
24	(55°)	150/27 → @0/80 → 150/24 → 0/60 → 100/ND
24A	(55°)	150/30 → @0/80 → 150/30
25A	(55°)	100/60 → @0/80 → 100/50
26#		80/90 → 0/160 → 80/85
27	(45°)	120/ND → @0/80 → 120/ND → 0/80 → 120/ND → @0/60 → 120/ND
28#		140/ND → 0/80 → 140/ND → 0/80 → 140/ND → 0/60 → 140/ND
29#		150/ND → 0/80 → 150/ND → 0/80 → 150/ND → 0/60 → 150/ND
30	(60°)	50/ND → @0/80 → 80/ND

ND = No Decompression (Actual no-decompression times in Table 13)

@ = Exercise performed during these surface intervals

= These profiles were planned but not dove because of study time limitations.

Surface Intervals of 60-80 min were chosen as the shortest which could be done while still allowing time for exercise and other intra-dive studies.

RESULTS

A total of 233 man dives resulting in 11 cases of decompression sickness (DCS) were eventually completed as shown in Table 10. On Profile 24 using MVAL97, 3 cases of DCS resulted but all 8 divers were treated. The 5 asymptomatic divers were not included in the final statistics, only 228 of the attempted 233 dives being included. All cases of DCS along with the type are noted in the table and the letters superscripting the type of DCS key the cases of DCS with the more detailed descriptions given in Table 11. All cases of DCS in this dive series were of the pain only type (Type 1) and easily treated with full recovery. Only two divers (#1 and #4) had more than one case of DCS and two symptoms (in diver #7 and #4) occurred under pressure, both during the 150 FSW repetitive dive profile.

The diving intensity for each diver throughout the series is shown in Table 12. The no-decompression limits tested are presented in Table 13 and the detailed decompression profiles are shown in Appendix C (Profile 20-30).

All Ascent Criteria labeled as MVAL were used only with the E-E Model while those labeled as VVAL were used only with the E-L Model. MVAL5 was the Ascent Criteria chosen for the MK 15/16 RTA as a result of Phase I testing. Initially, testing was directed at modifying MVAL5 (Table 1) to produce more reasonable no-decompression limits than had been obtained at the end of Phase I testing. (It should be noted that the numbers contained in the Ascent Criteria labels describe its position sequentially in the course of algorithm testing. Since every time even a single value was changed in any set of ascent criteria, a new number for the label resulted. Many more Ascent Criteria were created than were actually tested). Careful analysis of profiles tested during Phase I testing had shown that not all of the MPTT values in MVAL5 were used to control decompression stops. The MPTT which did control stops during Phase I testing are marked with an asterisk (*) in Table 1.

It was initially felt that modifications could be made to the MPTT values in MVAL5 which had not controlled stops to allow increases in no-decompression limits without significantly altering decompression profiles which had already been tested during Phase I. MVAL83 (Table 3) was the initial attempt at this. The one case of DCS which occurred after the initial 10 man-dives on Test Profile 20 was felt to be due to no-decompression limits which were too long for the second and third 60 FSW repetitive dives. MVAL83 was modified and became MVAL92 which was tested with 9 man dives on Profile 20 and 10 man-dives of Profile 22 without any incidence of DCS. At this point, MVAL92 was used to calculate the same dive profiles which had been tested using MVAL5 during Phase I testing. Comparisons of decompression schedules for Profiles 3-12 of Phase I are given in Appendix C. (The schedules computed using MVAL5 differ slightly from those in reference (1) because all ascent and descent rates used for computing decompression tables are 60 fpm here rather than the slower rates of reference (1)). MVAL92 gave longer decompression profiles for all test profiles except for Test Profile 10. MVAL92 was felt to be

TABLE 10
 PHASE II
 TEST DIVE RESULTS
 TOTAL MAN DIVES/DCS (TYPE)

PROFILE	20 (60/ND)*3	21 (40/ND)*1 100/ND	22 (100/ND)*4	23 (80/ND)*4	24 (150/27)*2 100/ND	24A (150/30)*2	25A (100/60)*2	27 (120/ND)*4	30 (50/ND)*1 80/ND
Mval 83	10/1(1) ^a								
Mval 92	9		10						
Mval 97	10	10 10	10/1(1) ^c	9 9/2(1) ^d	10/2(1) ^e 8/3(1) ^f				
Vval 09			9 [†]	9 10 [†]					
Vval 14	10/1(1) ^{†b}	10 [‡]	10 [†]						
Vval 18						10/1(1) [‡]	10	10 [†] 30 ^{†e}	10 [†]

Total number man dives completed 233 (203 from Phase II, plus 30 single 120/40 dives)

Type DCS 1 - Type I
 2 - Type II

Letter Superscripts Key DCS with Descriptions in Table 11.

- ^a - Dives used in computing expected DCS incidence for VVAL18 (see text).
- ^b - 120 FSW No-decompression single bounce dives (see text).
- [†] - 0.30 ATA PO₂ used by algorithm during surface intervals (see text).
- [‡] - All dive subjects treated after 3rd case DCS occurred.
- [‡] - 40/ND only, 100/ND not performed.

TABLE 11
DECOMPRESSION SICKNESS DESCRIPTIONS
PHASE II 30 July 1980-28 August 1980

Table Key	Diver #	Mod/Profile	Date	Date Last Dive	DCS Type and Location	Time of Onset Post Dive	Comments
a	1	MVAL83/20	30 JUL	26 JUL	(1) R. shoulder	10 min	R. shoulder injury age 14. Treatment Table 5
c	2	MVAL97/22	4 AUG	31 JUL	(1) R. arm	10 min after 3rd S.I.	Treatment Table 5.
d	3	MVAL97/23	7 AUG	5 AUG	(1) R. shoulder	1 min	Treatment Table 5.
	4		7 AUG	4 AUG	(1) R. shoulder	10 min	Pain started during 3rd S.I. Disappeared on compression at 80 FSW then recurred upon surfacing. Treatment Table 5.
e	5	MVAL97/24	12 AUG	8 AUG	(1) L. shoulder, elbow	15 min	Treatment Table 5
	6		12 AUG	6 AUG	(1) R. hip, knee	5 min	Excessive fatigue present, Treatment Table 5.
f	7	MVAL97/24	13 AUG	11 AUG	(1) R. shoulder	At 10 FSW stop on 1st 150 FSW dive	Had pain on initial compression to 150 FSW, went away on bottom, recurred at 10 FSW stop, Treatment Table 6 compression from 10 FSW stop
	8		13 AUG	11 AUG	(1) L. knee	40 min after 2nd 150 FSW dive	Treatment Table 5.
	1		13 AUG	11 AUG	(1) L. hip, knee	10 min after 3rd dive to 100 FSW	Knee pain initially during 2nd S.I. Gone after compression to 100 FSW. Treatment Table 5
b	9	VVAL14/20	25 AUG	19 AUG	(1) R. elbow	25 min	Treatment Table 5.
g	4	VVAL18/24A	26 AUG	21 AUG	(1) R. knee	At 10 FSW stop 2nd dive	Compressed to 30 FSW from 10 FSW stop. Did not run during S.I. Treatment Table 5.

S.I. = Surface Interval

TABLE 12
INDIVIDUAL DIVING INTENSITY

Date	7/30	31	8/1	4	5	6	7	8	11	12	13	18	19	20	21	22	25	26	27	28	29	
Profile	20	20	22	22	20	23	23	21	21	24	24	23	23	22	21	22	20	24A	25A	30	27	
Ascent Criteria	M83	MVAL92		MVAL97								VVAL09			VVAL14		VVAL18					
Diver #																						Diver #
1	@								*		@											1
2		*		@								*		*	*	*			*	*	*	2
3	*	*	*		*		@						*	*		*			*	*	*	3
4		*		*			@						*	*		*		@		*	*	4
5			*		*					@						*			*	*	*	5
6		0		*		*		*		@						*		*	*	*	*	5
7		*		*		*	*	*	*	@						*		*	*	*	*	7
8	*	*	*		*	*	*	*	*	@									*	*	*	8
9	*	*	*		*	*	*	*	*	*			*	*		0			*	*	*	9
10	*	*	*		*	*	*	*	*	1		*	*	*	*	*	*		*	*	*	10
11		*		*	*	*	*	*	*			*	*	*	*	*	*		*	*	*	11
12		*		*	*	*	*	*	*	*		*	*	*	*	*	*		*	*	*	12
13		*	*	*	*	*	1	1	*	*	2	*	*	*	*	*	*		*	*	*	13
14		*		*		*		*	*	*		*	*	*	*	*	*		*	*	*	14
15	*	*	*		*	*		*	*	*	*	*	*	*	*	*	*		*	*	*	15
16	*	*	*		*	*	*	*	*	*	*	*	*	*	*	*	*		*	*	*	16
17				*		*		*	*	*	*	*	*	*	*	*	*		*	*	*	17
18				*		*		*	*	*	*	*	*	*	*	*	*	*	*	*	*	18
19		*		*	*	*	*	*	*	*	*	*	*	*	*	*	*	*	*	*	*	19
20		*		*	*	*	*	*	*	*	*	3	*	*	*	*	*	*	*	*	*	20
21	*	*		*	*	*	*	*	*	*	*	*	*	*	*	*	*	*	*	*	*	21
22	*	*	*		*	*	*	*	*	*	*	*	*	*	*	*	*	*	*	*	*	22
23				*		*	*	*	*	*	*	*	*	*	*	*	*	*	*	*	*	23
24		*		*		*	*	*	*	*	*	*	*	*	*	*	*	*	*	*	*	24
25		*		*		*	*	*	*	*	*	*	*	3	*	*	*	*	*	*	*	25
26		*		*		*	*	*	*	*	*	*	*	*	*	*	*	*	*	*	*	26
27	*	*	*	*		*	*	*	*	*	*	*	*	*	*	*	*	*	*	*	*	27
28		*	*	*		*	*	*	*	*	*	*	*	*	*	*	*	*	*	*	*	28
29																					*	29
30																					*	30

* Completed Dive
 @ Decompression Sickness
 0,1,2,3 Did Not Complete Dive.(Removed during: 0-1st dive; 1-1st, 2-2nd,
 3-3rd Surface Interval.)

210 Man Dives Attempted
 7 Aborts
 11 Cases of
 Decompression Sickness

TABLE 13

Phase II No Decompression Times
 (Times are descent time plus time at depth
 (60 FSW/min ascent and descent rates))

Depth(FSW)	MVAL5	MVAL83	MVAL92	MVAL97	VVAL09	VVAL14	VVAL18
40	(365)*	235	215	<u>210</u>	245	<u>367</u>	367
50	10	109	109	103	112	143	<u>143</u>
60	6	<u>72</u>	<u>67</u>	<u>67</u>	74	<u>84</u>	74
70	5	50	47	47	51	57	51
80	4	36	36	<u>36</u>	<u>39</u>	43	39
90	3	26	26	26	29	35	32
100	3	19	<u>19</u>	<u>19</u>	<u>21</u>	<u>30</u>	27
110	2	16	16	16	15	24	24
120	2	13	13	13	12	19	<u>19</u>
130	--	11	11	11	10	16	16
140	--	9	9	9	8	13	13
150	--	8	8	8	7	11	11
160	--	7	7	7	7	9	9
170	--	6	6	6	6	8	8
180	--	6	6	6	6	7	7
190	--	5	5	5	5	7	7
200	--	5	5	5	5	6	6

*Model predicts infinite no-decompression time. Time shown reflects maximum time tested.

Underlined values show limits actually tested.

unsatisfactory in this regard so MVAL97 was created by selective modification of MPTT values in MVAL92.

MVAL97 initially seemed to give an acceptably low incidence of DCS when tested on Profiles 20, 21 and 22. Only one case of pain only DCS occurred in 40 man dives. However, when Profiles 23 and 24 were tested, the DCS incidence was obviously unacceptable (Table 10).

The high incidence of DCS on Profiles 23 and 24 using MVAL97 were felt to be due to the decompression times for the repetitive dives being too short. Examination of Profile 24 using MVAL97 in Appendix C shows that the total time for all stops for the first dive was 65.88 min while the total of all stop times for the second 150 FSW dive was 75.03 min after an 80 min surface interval. Then following a 60 min surface interval the no-decompression time at 100 FSW was 12.83 min, compared to 18.23 min for the same dive if there were no residual tissue tension, a decrease of only 4.40 min. Profile 24 is not the best profile to demonstrate the perceived problem with repetitive dives because the second dive to 150 FSW had a 3 min shorter bottom time than the first. Profile 24A gives a better comparison. Exactly 30 min is spent at 150 FSW on both the first and second excursion. The total of all stop times for the first 150 FSW dive using MVAL92 was 75.44 min and for the second 150 FSW dive 95.44 min. Thus, after a 60 min surface interval, MVAL97 would have added only an additional 20 min to the second 150 FSW dive decompression time. If one examines the decompression schedule for Profile 7 (Appendix C) which is for a 150 FSW/45 min dive, it will be seen that the total time for all decompression stops using MVAL97 would be 112.84 min. Since the second 150 FSW/30 min excursion had a total decompression time greater than for a 150 FSW/30 min bounce dive but less than for a 150 FSW/45 min bounce dive, one could conclude that the "residual nitrogen time" for the second 150 FSW/30 min in Profile 24A is not more than 15 min.

Direct comparisons of MK 15/16 RTA Profiles with U.S. Navy Standard Air Repetitive Dive Procedures is difficult. However, if Profile 24A had been done using U.S. Navy Standard Air Diving procedures, the second 150 FSW dive would have a "residual nitrogen time" of 24 min incurring an additional decompression obligation of 78 min or an increase of 344% in the total time spent at decompression stops. MVAL97 increased the total decompression time only 126%. The perception at this point was that the E-E Model predicted a too rapid offgassing during surface intervals. There was no adjustment which could be made to MVAL97 which would further lengthen the second 150 FSW decompression profile in Profile 20 without seriously reducing the 60 and 100 FSW no-decompression limits which were felt to be safe. It was at this point that the E-E Model was abandoned and the E-L Model substituted.

The first set of ascent criteria used with the E-L Model was VVAL09. VVAL09 would have lengthened the decompression time for both of the 150 FSW excursions in Profile 24A with the total stop time for the second excursion being 178% longer than the first. VVAL09 would also increase the no-decompression times at 60, 80 and 100 FSW but not to the extent that they were considered too unsafe to test. The first profile tested using VVAL09 was the 80 FSW no-decompression profile (Profile 23). After the initial 9 man-dives gave no cases of DCS, it was felt that the no-decompression limits of the second through fourth dives were too short. The most expeditious way to

lengthen these no-decompression limits was to have the MK 15/16 RTA use a P_{O_2} value of 0.30 ATA during the air breathing surface interval rather than the value of 0.21 ATA which had been used up to this time. This has the effect of increasing the offgassing rate by approximately 43% during the surface interval allowing longer no-decompression times on the following dives. This strategy proved safe as attested to by the fact there were no cases of DCS during the 10 man-dives on the 80 FSW no-decompression profile (Profile 23) and the 9 man-dives on the 100 FSW no-decompression profile (Profile 22). VVAL09 had significantly changed Profile 22 increasing the initial 100 FSW no-decompression limit by 9 min while reducing the no-decompression time for the 2nd 100 FSW excursion by about 5 min. The 3rd and 4th 100 FSW excursion no-decompression limits were largely unchanged. This redistribution proved successful. Having had this initial success, it was decided to see if even longer no-decompression limits for the first dive of each of the test profiles were possible.

VVAL14 was constructed with the longer halftime tissue surfacing MPTT values arbitrarily set to give a maximum no-decompression limit of approximately 6 hours at 40 FSW. Although a no-decompression time longer than 6 hrs at 40 FSW may have been possible, 6 hours was felt to be the longest bottom time which could be practically tested during this phase of testing. Initial testing of VVAL14 was on the 40 FSW no-decompression profile (Profile 21). Because of the long 40 foot bottom time it was decided to terminate the dive at the end of the 40 FSW excursion and the 100 FSW no-decompression repetitive dive was not done. An additional 10 man-dives were done on the 100 FSW no-decompression profile (Profile 22) with no cases of DCS. VVAL14 predicted a marked increase in the no-decompression limits for all three 60 FSW excursions on Profile 20. When the 60 FSW no-decompression profile (Profile 20) was tested, one case of elbow pain occurred some 25 min after the 3rd 60 FSW excursion.

It had been assumed that decompression sickness occurring after completion of all excursions on a given dive profile meant that it was the later profiles which needed adjustment. (The validity of this assumption could be called into question, but given the constraints of the study it seemed a reasonable working hypothesis until proven wrong). By this reasoning, one would assume that the initial 83.58 min no-decompression limit at 60 FSW predicted by VVAL14 was safe but that the no-decompression limit for the second and especially the third dive were too long. In deciding how to adjust VVAL14, several factors were taken into account. First the no-decompression limit for the second excursion could not be reduced without reducing the first no-decompression limit because both were controlled by the 40 min tissue. Second, and more important, was the fact that the total decompression time for Profile 10 of Phase I would be reduced about 5 min using VVAL14 compared to the MVAL5 schedule. It was desirable to modify VVAL14 such that the total decompression time for this and all other Phase I profiles should be equal to or greater than that of profiles computed using MVAL5. This was based on the working assumption that if the total decompression time for a profile was equal to or greater than that of a previously safe profile, that retesting of that profile would not be necessary (even if there was some redistribution of the stop depths). The validity of this will be discussed later. In the end, the surfacing MPTT for the 40 min tissue was decreased from 58 to 56 FSW, thus creating VVAL18. This had the immediate effect of cutting back the 60 FSW

no-decompression time to 73.2 min. The time for this phase of testing was limited and since the total time at 60 FSW for Profile 20 had been decreased compared to the MVAL92 and MVAL97 profiles (which were felt to be safe), it was decided to move on to the 150 FSW and 100 FSW decompression profiles. Since the previous experience with Profile 24 had given such a high incidence of decompression sickness the 100 FSW no-decompression excursion following the second 150 FSW excursion was removed. However, to keep the total dive time around 6 hours the time spent at 150 FSW was increased from 27 to 30 min. This revised 150 FSW schedule (Profile 24A) was not free of DCS, one subject experiencing a mild knee pain at the 10 FSW stop of the second 150 FSW excursion. This diver was isolated from the other 9 and got complete relief at 30 FSW during compression to 60 FSW. Of additional interest was the fact that he was one of the 3 divers who did not run during the surface interval for reasons unrelated to the dive. Profile 25A proved safe and this was particularly gratifying because during Phase I testing the 100 FSW/60 min profile (Profile 8) using MVAL5 gave 1 case of Type 2 DCS (1).

Since the time for the series was drawing to a close there was time to test only 2 more profiles and the next 20 man-dives on the 120 FSW no-decompression profile (Profile 27) and the 50 FSW no-decompression profile (Profile 30) were performed without any cases of DCS occurring. During a subsequent dive series done to primarily test helium-oxygen tables, an additional thirty 120 FSW no-decompression dives on nitrogen-oxygen were done for training purposes. These were single dives, only a single 120 FSW excursion being done. They were done under the same condition as those in the present study. No cases of decompression sickness occurred during these 30 man dives.

The E-L Model using the VVAL18 Ascent Criteria was chosen as the basis for the final version of the MK 15/16 RTA which will eventually be incorporated into the UDC. Program TBLP7 (reference 1) using VVAL18 was used to generate a complete set of decompression tables which are presented in Appendix D.

DISCUSSION

When this second dive series was undertaken to improve the MK 15/16 RTA from Phase I testing the primary goal was to obtain an operationally useful algorithm which could produce a set of operationally useful decompression tables. Although a great deal of initial planning went into the initial algorithm, experience from previous dives indicated that changes would in all likelihood have to be made as the series progressed based on the incidence of DCS. The time constraints of the study meant that opportunities were not always available to thoroughly test various options before choosing what was felt to be the optimum one. In addition, opportunities were not always available to retest all profiles after an algorithm change and some reliance had to be placed on comparison of current dive profile printouts with those of previously tested profiles. Since safety was the primary consideration, changes in the MK 15/16 RTA were made such that any perceived deviation from the optimum was made on the side of longer decompression times (or shorter no-decompression limits). In the end, schedules down to 100 FSW for 60 min appear to be on the conservative side. Except for the 120 FSW no-

decompression dive which were felt to be safe, improvement in safety (compared to Phase I profiles) of other decompression profiles below 100 FSW could not be conclusively demonstrated. For the profiles below 100 FSW, VVAL18 gave longer decompression times than MVAL5 so that the current MK 15/16 RTA is probably safer than the previous Phase I version even though the increase in safety cannot be quantitated.

In order to make the most efficient use of the time available, several statistical compromises had to be made. During Phase I testing, 30 man-dives on each tested profile was felt to be the minimum which would give a reasonable statistical indication of safety. The nature of the dives here were usually several no-decompression profile separated by surface intervals. Thus, 10 man-dives on Profile 20 actually involved 30 man-excursions to 60 feet. The assumption was made that if the MK 15/16 RTA could predict safe decompression profiles on three successive repetitive dives that this demonstrated the same degree of safety as if three times as many non-repetitive profiles were done with fresh divers being used for each profile. An additional assumption was that all of the different test profiles equally tested the safety of the algorithm which meant that the overall rate of decompression sickness for all the profiles tested would be a reasonable indication of the overall safety of the algorithm. The results of this study do not prove or refute this assumption.

As already alluded to, certain compromises had to be made because what was tested was a computer algorithm and not a set of decompression tables. When the change to the E-L Model was made it was decided to have the MPTT's increase linearly with depth and this was adhered to throughout the series¹. This meant that once the 9 surfacing MPTT's were chosen and the depth increment (which was the same for all tissues) chosen, all other MPTT's were defined. Initially, the depth increment was chosen so that the 240 min MPTT's would predict what were felt to be reasonable ascent rates for air saturation defined. Initially, the depth increment was chosen so that the 240 min MPTT's would predict what were felt to be reasonable ascent rates for air saturation dives. These rates were taken from unpublished data obtained at NEDU which was used to develop a saturation decompression profile from 60 FSW to the surface which took approximately 36 hours. In the end, none of the profiles tested used the 200 min or 240 min tissues (which are the ones controlling saturation decompression) as the controlling tissues so adjusting VVAL18 to predict safe saturation profiles can be left to a later date. (The actual 60 FSW saturation decompression table development will be the subject of a future report). All of the surfacing MPTT's were determined from the safe no-decompression limits to depths of 120 FSW. The 40 FSW no-decompression limit was controlled by the 120 min tissue; the 50 FSW limit by the 80 min tissue; the 60, 80 and 100 FSW limits by the 40 min tissue and the 120 FSW limit by the 10 min tissue. The 140 FSW and deeper no-decompression limits would be controlled by the 5 min tissue but time was not available to test these limits.

¹ This linear increase with depth is based on observations that the depths of saturation excursions increase linearly with depth (13, 14, 15). The MK 15/16 RTA will, therefore, predict this linear relationship.

One of the peculiarities of the E-L Model is that the total decompression time for any decompression dive is almost totally dependent on the surfacing MPTT. Varying the rate of depth dependent increase in the MPTT changes the stop depth distribution but not the total decompression time very much. This means that to lengthen the decompression time for a given dive, some decrease in a no-decompression time would have to be tolerated. Thus, the MPTT had to be adjusted to give the best overall compromise between total decompression times for long dives and no-decompression limits. Every attempt was made to keep the no-decompression limits as long as possible, while providing for safe decompression dives.

Offgassing During Surface Interval

The most significant finding of this study was the failure of the E-E Model to adequately compute safe repetitive dive decompression profiles without seriously reducing what were felt to be safe no-decompression limits. This conclusion was based mainly on the test results of the 60 FSW no-decompression profile (Profile 20). MVAL83 was felt to have a reasonable no-decompression limit for the first 60 FSW dive and the DCS which occurred was ascribed to the model predicting too long a no-decompression limit for the second and third dive. Subsequent testing of Profile 20 using Ascent Criteria MVAL92 and MVAL97 gave DCS free dives and while the initial no-decompression limit of 67 minutes at 60 FSW was felt to be conservative, it was not considered excessively so. However, after the failure of MVAL97 to compute a safe decompression profile for the 150 FSW decompression dive (Profile 24) a further reduction in the surfacing, MPTT's was called for. However, as reductions were made to lengthen the total decompression time for the second 150 foot dive, the 60 foot no-decompression limit was progressively reduced.

The E-L Model had been under consideration for some time and had the desired property of drastically slowing the rate of tissue offgassing. Since the no-decompression limits depend heavily on the surfacing MPTT the E-L Model had the effect of slowing offgassing during surface intervals and lengthening decompression time (or conversely reducing no-decompression times) on subsequent dives without materially affecting the initial no-decompression limits. VVAL09 was the first set of Ascent Criteria for the new E-L Model tested. After the initial 9 man-dives on the 80 FSW no-decompression profile (Profile 23) produced no cases of DCS, it was decided that the no-decompression bottom times for the second through fourth 80 FSW excursions were now too short. It was desired to see if these no-decompression times could be extended without affecting the long 150 FSW and 100 FSW decompression profiles. To do this it was decided to use a PO_2 value of 0.30 ATA in the algorithm during surface intervals rather than a PO_2 of 0.21 ATA which is what the divers were actually breathing. It should be noted that this change in PO_2 was an artificial adjustment of the MK 15/16 RTA only, the divers actually breathed air with a PO_2 of 0.21 ATA during the entire surface interval. This adjustment was made for Profiles 20, 21, 22, 23, 27 and 30 only. A value of 0.21 ATA was used by the MK 15/16 RTA for Profiles 24A and 25A. As it eventually turned out this adjustment proved safe for all no-decompression profiles with the exception of the 60 FSW no-decompression profile (Profile 20) using VVAL14.

Exactly why this artificial lengthening of repetitive no-decompression times proved safe cannot yet be ascertained. One explanation is that the model predicts that the ratio of offgassing rates at 0.21 ATA to that at 0.7 ATA is too small². Another explanation is that the exercise performed during the surface intervals accelerated inert gas elimination which allowed subsequent increases in no-decompression times. Further studies will be required to firmly establish the reason. For the present, it was decided to use a PO₂ of 0.21 ATA in the MK 15/16 RTA for all surface intervals which would (at the worst) make the algorithm slightly conservative during operational use for repetitive no-decompression dives.

Perusal of Profiles 20-30 of Appendix C demonstrates the effect of the surface interval PO₂ change in the algorithm as discussed above. Note that for the decompression profiles produced by VVAL09, VVAL14 and VVAL18, the profiles using a 0.21 ATA PO₂ and 0.30 ATA PO₂ during the 1 ATA surface interval are both detailed in Appendix C. For Profile 23, a 154% increase in the total no-decompression time for the 2nd through 4th 80 FSW excursions was obtained by increasing the PO₂ used by the algorithm for VVAL09, and this increase rose to 162% for VVAL18. Although testing showed these increases in no-decompression time to be safe, these increases could not be incorporated into the final model because a 0.21 ATA PO₂ was used for all surface intervals in Profiles 24, 24A, and 25A.

The extension of the 40 FSW no-decompression limit from 210 min to 367 min was based on the fact that the inert gas tension at 40 FSW breathing a 0.70 ATA PO₂ is the same as that at 30 FSW breathing air (21% O₂) and 30 FSW on air is very close to the saturation no-decompression limit. While this line of reasoning may not be applicable in all cases, it was used as a rationale for extending the 40 FSW no-decompression bottom time. Since the maximum total dive time under consideration during this study was 6 hours, it was decided to test a bottom time close to 6 hours at 40 FSW although longer bottom times at this depth were probably possible. A 367 min no-decompression limit bottom time was successfully tested on 10 man-dives using VVAL09.

Comparison With Air Tables

Comparisons of the no-decompression times predicted by the MK 15/16 RTA using a 0.7 ATA PO₂ at depths of equivalent inert gas tensions on air (the so-called Equivalent Air Depth or EAD) to 174 FSW are given in Table 14 along

² As pointed out in the derivation of the E-L Model in Appendix A, the simplifying assumption was made that inspired and arterial oxygen tensions were equal. This results in the ratio of offgassing rates at 0.21 ATA compared to 0.7 ATA being slightly greater than if this assumption were not made. Thus, the model already starts out by overestimating the 0.21 ATA/0.7 ATA offgassing ratio. This dive series showed that a further increase in the 0.21 ATA/0.7 ATA offgassing ratio (by having the model assume a PO₂ of 0.3 ATA during surface intervals) could still produce safe repetitive dives. In order to obtain this increased ratio while having the E-L Model use a value of 0.21 ATA for the PO₂ during surface intervals would require modification of the model.

TABLE 14

Comparison of No-Decompression Limits at Equivalent Nitrogen Depths

(Current U.S. Navy Air limits)		(Limits Predicted by E-L Model)		Difference Air Limit - VVAL18 Limit (min)
Depth on Air (FSW)	Air No-D Limit (min)	Equivalent Depth on 0.7 ATA PO ₂ (FSW)	VVAL18 No-D Limit (min)	
30	360 [#]	40	367	- 7
40	200	48	162	+38
50	100	56	91	+ 9
60	60	64	62	- 2
70	50	71	50	0
80	40	79	40	0
90	30	87	34	- 4
100	25	95	30	- 5
110	20	103	26	- 6
120	15	111	23	- 8
130	10	119 [@]	19	- 9
140	10	127	17	- 7
150	5	135	14	- 9
160	5	143	12	- 7
170	5	150	11	- 6
180	5	158	9	- 4
190	5	166	9	- 4
200	5	174	8	- 3

[@] Denotes deepest depth at which 0.7 ATA no-decompression limits actually tested.

[#] For 30 FSW air limit 360 min is the longest time recommended by the U.S. Navy Diving Manual.

Dashed line indicates maximum depth for using MK 15/16 RTA.

with the standard U.S. Navy air no-decompression limits. A no-decompression limit of 40 min was chosen for 80 FSW because the PO_2 on air is close to 0.7 ATA (actually, the PO_2 on air is 0.70 ATA at 77 FSW). No-decompression limits down to 120 FSW were tested using the MK 15/16 RTA which is an Equivalent Air Depth (EAD) of 130 FSW. Below 80 FSW the MK 15/16 RTA predicts longer no-decompression limits on air than given by the limits published in the U.S. Navy Diving Manual. The limits below 120 FSW are also longer but were not tested. Whether the no-decompression limits below 120 FSW predicted by the MK 15/16 RTA will prove safe with operational use or will have to be reduced remains to be seen. The 40 man-dives done testing the 120 FSW Profile with no incidence of DCS predicts a maximum expected incidence of DCS to less than 7.5% at the 95% confidence level (assuming DCS occurs randomly following the binomial distribution)³. Berghage (7) has reviewed the incidence of DCS using the U.S. Navy Air Tables from 1971 through 1978. He has documented some 965 no-decompression dives from 40 to 190 FSW with 13 cases of decompression sickness occurring. On the 130 FSW schedule alone (which is the EAD for 120 FSW breathing a 0.70 ATA PO_2), there were 152 man dives with 2 cases of decompression sickness for a maximum expected incidence of 4% at the 95% confidence limit. Clearly, these are more man-dives than could be accomplished during experimental man-testing of profiles in a reasonable time.

Comparing decompression dives predicted by the MK 15/16 RTA with U.S. Navy Air Tables presents a bit of a problem. While the EAD concept would permit matching of bottom depths, any decompression stops shallower than 80 FSW would have a higher PO_2 in the breathing gas with a constant 0.7 ATA PO_2 than with air. A priori, one would expect the MK 15/16 RTA profiles to be shorter since the conventional wisdom is that increased inspired PO_2 will decrease decompression time. During Phase I testing, the 100 FSW for 60 min profile was considered unsafe because of 1 case of Type 2 decompression sickness in 10 man dives. The EAD profile is 110 FSW for 60 min, which according to Berghage (7) was dove 31 times with no cases of DCS. (The next shallower schedule, 110 FSW for 50 min was dove 1198 times with 5 cases of decompression sickness for a maximum expected incidence of 0.1%). The 100 FSW for 60 min profile using MVAL5 in Phase I had a total decompression stop time of 50.9 min compared with 54 min for the air tables. VVAL18 increased the total decompression stop time to 65.10 min but was dove only 10 times with no cases of decompression sickness occurring. Clearly one would say that the 110 FSW/60 min U.S. Navy Standard Air Decompression Schedule is safe and that the current testing done for the constant 0.70 ATA PO_2 version is insufficient to clearly establish whether the equivalent nitrogen depth schedule to 100 FSW

³ The maximum expected incidence predicted by the binomial distribution is the upper bound on expected incidence based on the number of man dives evaluated. The lower bound is the actual observed incidence. There was no DCS on these 40 dives so the actual incidence is 0.0%. However, based on this small sample one can only say that as more dives are done, the maximum incidence should not exceed 7.5%. If 100 DCS free dives are done, the observed incidence is still 0.0% but the expected incidence falls to 3.0%. Thus, when interpreting the DCS incidences reported here, one should realize that the true incidence of DCS will probably be between the observed incidence and the maximum expected incidence.

predicted by the MK 15/16 RTA is too conservative. Certainly one would expect the air schedule to be no shorter than the 0.7 ATA PO₂ schedules and yet it currently is. This potential deficiency in the MK 15/16 RTA remains to be resolved. Overall, the MK 15/16 RTA profiles contain more decompression time than do the U.S. Navy Standard Air Tables at Equivalent Air Depths. It is our impression from testing that schedules at or below 100 FSW are not over conservative. If the above comparison with air tables is valid then one would expect a lower incidence of decompression sickness using tables generated by the MK 15/16 RTA than on comparable air tables. However, it must be remembered that air tables are rarely dove to the foot and the minute so that air table statistics may make tables appear safer than they actually are.

While the MK 15/16 RTA was used to compute a complete set of tables which appears in Appendix D, the intent is to eventually program it into an Underwater Decompression Computer (UDC). In this application, no empirical adjustments to tables can be made because the UDC will take into account every move and tailor a decompression schedule exactly for a particular dive profile. So, if a diver using the UDC chose to empirically lengthen his 20 FSW stop, the MK 15/16 RTA will shorten the 10 FSW stop. During repetitive dives the UDC would take into account only the actual time spent at each depth and charge the diver additional decompression based only on actual time at each depth. Decompression Tables are necessarily more restrictive since they are usually published in fixed depth and time increments. This means that in use, decompression times using the UDC will be shorter than that computed by tables even though exactly the same algorithm used in the UDC is used to compute tables.

Final Ascent Criteria Statistics

VVAL18 was the final set of ascent criteria result from the dive series. Since not all test profiles were dove on VVAL18, dives done on other algorithm modifications were used to establish its overall degree of safety. The no-decompression limits predicted by and actually tested are underlined in Table 13 for all ascent criteria. VVAL18 was used to test the 50 FSW and 120 FSW no-decompression limit with 50 man dives and no cases of DCS occurring. The 40 FSW and 100 FSW no-decompression limits were dove 20 times using VVAL14 and since VVAL18 predicts no-decompression limits equal to or less than those predicted by VVAL14 at these depths, it should be as safe as VVAL14. VVAL09 established the 50 FSW no-decompression limit on 19 DCS-free dives and it predicted a 39 min limit, the same as for VVAL18. Thus, the same limits at 40, 50, 80, 100 and 120 FSW predicted by VVAL18 were dove on 80 man dives with no cases of DCS. VVAL18 predicts a 74 min no-decompression limit for 60 FSW. The closest limit actually tested was the 72 min limit using MVAL83 and even though there was one case of DCS when the 60 FSW repetitive dive profile (Profile 20) was done, the initial limit was felt to be safe as mentioned earlier. As a matter of fact, examination of the Profile 20 schedules actually tested would leave one hard put to decide which was the safest. Since the schedule predicted by VVAL18 is the shortest of all it is safe to assume that it will be at least as safe as those actually tested. Thus, the 2 cases of pain only DCS in 30 man-dives done on Profile 20 would probably be the absolute worst case.

Table 15 shows a compilation of statistics from Phase I and Phase II testing. Overall, the only dives which could be definitely excluded from the final statistics used in evaluating the safety of VVAL18 were those done on Profile 24 using MVAL97 because VVAL18 drastically reduced the DCS incidence on a very similar profile (24A). Including the thirty 120 FSW no-decompression dives done subsequent to this series and excluding those done on Profile 24 using MVAL97, a total of 215 man-dives are considered in the final evaluation of VVAL18 with a total of 6 cases of DCS. This gives a value of 5.5% for the maximum expected incidence of DCS assuming a random occurrence which follows the binomial distribution at the 95% confidence level. One could make an argument for not including the results of Profile 20 using VVAL14 because of the large increase in the 60 FSW no-decompression limit (which could be argued to be the cause of the one case of DCS) and Profile 23 testing using MVAL97 because VVAL18 predicts a 40 minute reduction in total dive time. By subtracting out these 28 man dives and 3 cases of DCS we are left with 186 man-dives with 4 cases of DCS. This would give a maximum expected incidence of 5% for decompression sickness. Since excluding these dives lowered the expected incidence, this was not done making the maximum expected incidence of DCS for Phase I testing 5.5% or less as shown in Table 15.

Comparison of the decompression profiles predicted by VVAL18 with those predicted by MVAL5 for dive Profiles 3-12 (which were used in Phase I testing) shows that the VVAL18 decompression profiles are longer in every case. Stop depths using VVAL18 tend to start shallower than the MVAL5 but Phase I testing could not really establish whether the deeper stops predicted by MVAL5 were any safer than the shallower stops predicted by earlier Phase I ascent criteria (1). Although Hills (8) suggest deeper stops might be beneficial, he only addresses air diving and his argument relies on the fact that the increased PO_2 of air at increased depth will cause inert gas to be removed at a faster rate deep than shallow. As a matter of fact, the E-L Model does predict more rapid inert gas elimination at increased depth when breathing fixed O_2 fraction gases, but since the tables tested in this study have a constant PO_2 , no advantage in offgassing rates from deeper stops would be expected. Some redistribution of total decompression stop time does occur with VVAL18 compared with MVAL5, however. For instance, in Profile 3, VVAL18 decreases the total decompression from the first 150 FSW excursion by 20.6 min while increasing the stop times from the second excursion by 60.95 min for an overall increase of 40.35 min in total decompression time. The reason for this is that in Profile 3 the "surface interval" is taken at 30 FSW and the increases in decompression time predicted by VVAL18 are mostly at the 30 FSW or shallower stops and only become evident during decompression all the way to the surface on the second dive. This same phenomenon occurs in Profiles 4, 5 and 11 (Profile C of reference (1)) but in Profile 11 the total decompression stop time was decreased only 0.28 min from the first 150 FSW excursion while the total decompression for the second dive was increased 20.83 min. While Profile 11 was not tested during Phase II, Profile 24A was similar and felt to produce more decompression stress than Profile 11. Thus, the 1 Type I DCS in 10 man-dives on Profile 24A using VVAL18 was considered a vast improvement over the 1 Type 2 DCS in 10 man-dives on Profile 11 using MVAL15. It was concluded that if Profile 11 was done on VVAL18, the DCS incidence would be lower than with MVAL5.

TABLE 15

Summary of Man-Dives and
Decompression Sickness (DCS) Incidence

	Man Dives	TOTAL DIVES Cases DCS	Maximum [@] Expected Incidence (95% Confidence)
PHASE I	455 [*]	24 [*]	7.5%
PHASE II	<u>228[#]</u>	<u>11</u>	<u>7.8%</u>
TOTAL	673	35	6.8%

Dives Falling Within Final
E-L Model Using VVAL18

	Man Dives	Cases DCS	Maximum [@] Expected Incidence (95% Confidence)
PHASE I	178	2	3.5%
PHASE II	<u>215</u>	<u>6</u>	<u>5.5%</u>
TOTAL	393	8	3.5%

Includes only the 3 man-dives on Profile 24 using MVAL97 which resulted in DCS. The other 5 unaffected divers were recompressed with the symptomatic divers and are included in the 233 attempted dives in Table 10 but were not included here in the final statistics.

@ Maximum Expected Incidence computed assuming a binomial distribution.

* A mistake in reference (1) erroneously reported 445 man-dives and 22 cases of decompression sickness. The values in this table are the correct values from Table 3 of reference (1).

The increases in total decompression time for the bounce dive Profiles 6, 7, 8, 9, 10 and 12 were greatest in areas which had been perceived to have the highest probability of DCS. The 150 FSW for 60 min decompression time was increased by 87.03 min. This profile could not be tested using VVAL18 but the substantial increase would undoubtedly give much less DCS than the 3 cases in 20 man dives seen with MVAL5. Profile 7 was also highly unsatisfactory when tested in Phase I using MVAL5 giving 3 cases of pain only DCS in 10 man dives. VVAL18 would increase the total decompression time for this profile 33.72 min. Again, there was no time for retesting of this profile. Profile 8 was retested as Profile 25A and the 8.29 min increase in total decompression time using VVAL18 resulted in 10 DCS-free man-dives in contrast to the one case of Type 2 DCS in 10 man-dives using MVAL5. VVAL18 increased total decompression time of Profile 9 by 7.14 min and since there had been 20 DCS-free man-dives done using MVAL5, this profile too was felt to be safe using VVAL18. Profile 10 (called Profile A in reference 7) was considered safe using MVAL5 and the total decompression time was increased a miniscule 0.72 min by VVAL18, the big difference being that MVAL5 had the first stop at 50 FSW while VVAL18 predicted a first stop depth of 20 FSW. Profile 12 (Profile C of reference 1) which gave no cases of DCS in 20 man-dives using MVAL5 had its first stop depth decreased from 30 to 20 FSW but the total decompression time increased 31.02 min.

In the final analysis, stop depth distribution was felt to be of lesser importance than total decompression time in these constant PO₂ tables. Based on the analysis in the preceding paragraph, it was concluded that dives which fell within the final depth/time domain limits from Phase I testing would have the same or lower incidence of DCS if done on the final MK 15/16 RTA using VVAL18. There were 178 man-dives resulting in 2 cases of DCS from Phase I testing which met these criteria and these are shown in Table 15. The maximum expected incidence was computed assuming a binomial distribution at the 95% confidence level. At the first glance, it might appear that Phase II dives gave a higher incidence of DCS than Phase I dives for dives falling within the final E-L Model limits. However, in Phase I testing, 70 man-dives were done on Profiles 4 and 5 which were felt to be unusually safe. Phase II testing was spread out more evenly, and may have concentrated on more stressful dives especially since surface intervals were taken at 1 ATA breathing air and not at 10 FSW breathing 0.7 ATA PO₂ as in Phase I. To put the magnitude of Phase I and Phase II testing in perspective, it should be pointed out that the U.S. Navy Standard Air Tables including testing of some 62 repetitive dive combinations were tested on a total of 688 man-dives resulting in some 47 cases of decompression sickness (9,10). The present series and the one used to test the original air tables were of comparable size but some differences should be noted. The Standard Air Tables were tested to depths of 290 FSW while the 0.7 constant PO₂ Tables described here were tested nominally to depths of 150 FSW. Of all 228 Phase II dives, 198 were repetitive dives and of the 445 Phase I man-dives, 289 were repetitive dives. Only 124 repetitive man-dives were done during Standard Air Table testing. This, of course, reflects a different philosophy with regard to how the tables will be used. The Standard Air Tables were developed for salvage type diving where mostly single dives at a fixed depth would be done. The MK 15/16 RTA is designed to be used in the free swimming diver who will be making multiple excursions over depths from 0 to 150 FSW.

When the Phase II dive series was first designed, it was to approximate worst case conditions for diving. Thus, cold water was used with divers exercising at depth and resting during decompression. Vann (11) has shown that exercise at depth and rest during decompression result in a higher incidence of DCS than exercising continuously throughout the entire dive. In actual use, there would be some degree of exercise during the surface intervals and this was simulated by having the divers run. In retrospect, however, it is quite possible that the running speeded up tissue offgassing making the repetitive dives safer than they would be if all surface intervals were taken at rest. Only after some years of experience are gained on these tables will the importance (or unimportance) of this oversight become apparent. Another shortcoming of the study was the selection of 60-80 min times for all surface intervals. Time simply wasn't available to test other surface intervals to any level of statistical significance. Again, operational experience will establish the importance of this shortcoming.

Decompression Sickness Symptoms

As previously mentioned, divers dove every other day and only a single diver had DCS more than one time (Table 8, Table 12). All divers who suffered from DCS were eventually returned to the study after a minimum 48 hr layoff. Not much can be said about the DCS which occurred on this dive series except that it all responded quickly to recompression. It is interesting to note that Diver 8 had a rather severe fracture of the right leg some years ago in a motorcycle accident with some joint involvement but when DCS occurred in this diver it was in his normal left leg. Diver 1 had a shoulder injury at age 14 which was either a bad sprain or dislocation. This seemed significant the first time he got DCS but the second time he had symptoms on a subsequent dive it was in his left hip and knee. The adage that lower extremities are involved more by DCS for deep dives and upper extremities by shallow dives seems to have been upheld in this study. No lower extremity symptoms were seen on dives shallower than 150 FSW. On the 150 FSW dives there was a total of 6 symptoms, 4 of which were lower extremity and 2 of which were upper extremity. There were 5 symptoms for dives shallower than 150 FSW, all of them in the upper extremity.

During the course of the dive series, many more cases of potential DCS were evaluated than treated. During surface interval exercise, many cases of aches in and around joints were evaluated. Many times the location and character of the aching sufficed to make the determination between DCS and traumatic pain. In two cases (d4 and f1 of Table 11) divers presented with mild pain during a surface interval which at the time was not felt to be DCS. However, this pain did disappear at depth during the subsequent repetitive dive and reappeared within 10 min after surfacing from the final dive. These cases were obviously Type I DCS and illustrate the difficulty in distinguishing orthopedic trauma from Type I DCS by even experienced individuals. In general, pain occurring immediately post dive was considered DCS. Pain which arose during or after the run during surface intervals was considered DCS if it increased in severity with time after stopping exercise or had not substantially resolved in 20 min. All pain which fell into this category was of the very mild variety, more intense pain was always considered DCS unless

it could be specifically related to trauma such as a twisted ankle or knee. All cases of DCS in this dive series were mild enough to permit a complete neurological examination before treatment so no underlying neurological symptoms were missed. As noted in Table 11, all cases of Type I DCS responded to recompression.

Shoulder pain at depth was particularly hard to evaluate because the MK 15 UBA shoulder straps had a way of cutting into the diver's shoulders and many times divers could relieve shoulder aches or pains by shifting their MK 15's on their back. The one case of shoulder pain which occurred under pressure (f7 in Table 11) was unusual in that it was apparently present just before initial compression to 150 FSW but had not been present earlier in the day. This pain was relieved during compression to 150 FSW but reoccurred at the 10 FSW stop during decompression. At the time of initial treatment, it was not known this pain had been present before the dive, and in retrospect this may not have been DCS at all. However, the incidence of DCS in other divers after the 2nd and 3rd excursion demonstrated this particular 150 FSW schedule (Profile 24) was unsatisfactory using MVAL97. The other case of pain under pressure (g4 in Table 11) was a right knee pain after the 2nd 150 FSW excursion in a diver who did not run during the surface interval. Since there were no other cases of DCS on this profile one wonders if the reasons this particular diver got symptoms was because he did not exercise and thus had a lower offgassing rate between dives than other members of the dive team. However, two other divers did not run during the surface interval on that same profile and they did not have any DCS symptoms. Finally, it should be noted that symptoms of DCS tended to occur shortly after the dive surfaced, times ranging from 1 to 40 min. This fact was one of the primary reasons why we felt a particular excursion was safe if no DCS symptoms arose during the surface intervals which were all 60-80 min long.

Decompression Tables

While the original intent was to program the MK 15/16 RTA and VVAL18 ascent criteria into a UDC for real time decompression schedule calculation, a set of tables had to be produced for immediate use and emergency use should a UDC fail. Program TBLP7 (5) which uses the concepts of the E-L Model was used to generate the tables shown in Appendix D. When comparing these profiles to those in Appendix C for VVAL18, keep in mind that the times in Appendix C are actual times at depths while the bottom times in the Appendix D tables are actual time at depth plus descent time. These tables use the concept of the limit line to show which tables are outside of the current limits on the MK 15/16 RTA. These tables are designed to be dove to the foot and minute and right up to the limit line. Tables below the limit line are provided for emergency use when divers are unable to begin decompression exactly on time because of fouling or other reasons. Tables to 170 FSW are provided to cover the inadvertent excursion below 150 FSW. These tables can be used with any underwater breathing apparatus which maintains a PO_2 of at least 0.7 ATA at all depths using a nitrogen diluent and which warns the diver when the PO_2 falls below 0.6 ATA. As with all U.S. Navy Tables, the bottom time is the time from leaving the surface to leaving the bottom. These tables are used in

the same way as the Standard Air Tables with the exception that repetitive groups are not available at present. However, if all bottom times for dives done during the previous 12 hours are added and decompression table selection done using that cumulative bottom time and the deepest depth attained during that period, repetitive dives may be done. Repetitive group; and diving procedures will be the subject of a future report.

Summarization

The final version of the MK 15/16 RTA was the E-L Model using the VVAL18 ascent criteria. Since not all profiles actually dove were computed using the final MK 15/16 RTA comparison of predicted profiles with those actually dove was done. This comparison showed that the final MK 15/16 RTA should have a lower DCS incidence than all Phase I dives falling within the restricted depth/time domain for MVAL5 (178 man-dives, 2 cases DCS). In this dive series, only the 18 man-dives dove on Profile 24 using MVAL97 were not indicative of the safety of the final MK 15/16 RTA and were excluded from the final statistics shown in Table 15. Since evaluation of the MK 15/16 RTA was conducted under conditions designed to maximize decompression stress, and since in many cases the profiles predicted by the final MK 15/16 RTA have considerably more decompression time (or shorter repetitive dive no-decompression limits) than profiles actually tested the actual incidence of DCS should be well below the 3.5% maximum predicted incidence shown in Table 15. Another factor substantiating this is that all cases of DCS which occurred in Phase II testing, even on profiles eventually excluded from the final statistics, were easily treatable Type I DCS even though the dive series concentrated on what were perceived to be very stressful profiles. This leads to the conclusion that the MK 15/16 RTA is safe enough to be used operationally within the same depth/time domain restrictions established during Phase I testing, either as a UDC program or as the Decompression Tables presented in Appendix D. While further man-testing would be productive in extending depth/time limits, this need not be done before the MK 15/16 RTA is used operationally. Further man-testing would only be mandatory should the incidence of DCS during operational use be unacceptable.

CONCLUSIONS AND RECOMMENDATIONS:

1. The final version of the MK 15/16 RTA using VVAL18 has been adequately tested and is safe enough to be used operationally.
2. The MK 15/16 RTA be programmed into the UDC and the tables in Appendix D be used in the interim. Phase I depth/time restrictions should remain.
3. The MK 15/16 RTA can be used with any UBA which maintains a PO_2 of 0.7 ATA or greater at all depths, uses nitrogen as the inert gas, and which warns the diver if the PO_2 falls to 0.6 ATA or lower.
4. Relaxation of depth/time limitations currently placed on the MK 15/16 RTA only be considered after operational experience is gained and only after further man-testing.

REFERENCES

1. Thalmann, E.D., I.P. Buckingham and W.H. Spaur. Testing of Decompression Algorithms for Use in the U.S. Navy Underwater Decompression Computer: Phase I. U.S. Navy Experimental Diving Unit Report 11-80, August 1980.
2. Zumrick, J.L. Manned Evaluation of The Swimmer Life Support System Mark I. U.S. Navy Experimental Diving Unit Report 11-78, February 1978.
3. Paulsen, H.N., R.E. Jarvi. Swimmer Life Support System Technical Evaluation. U.S. Navy Experimental Diving Unit Report 14-76, March 1977.
4. Gray, C.G. and E.D. Thalmann. Manned Evaluation of the Pre-Production MK-16 Underwater Breathing Apparatus. U.S. Navy Experimental Diving Unit Report 13-80, August 1980.
5. Thalmann, E.D. Computer Algorithms Used in Computing the MK-15/16 Constant 0.7 ATA Oxygen Partial Pressure Decompression Tables. U.S. Navy Experimental Diving Unit Report 1-83, January 1983.
6. 0.7 ATA Constant O₂ in N₂ Bounce Dive Series. Navy Experimental Diving Unit Test Plan Number 80/29, August 1980.
7. Berghage, T.E. and D. Durman. U.S. Navy Air Decompression Risk Analysis. Naval Medical Research Institute Report NMRI 80-1, January 1980.
8. Hills, B.A. Decompression Sickness Volume 1, New York: John Wiley & Sons, 1977.
9. DesGranges, M. Standard Air Decompression Schedules, U.S. Navy Experimental Diving Unit Research Report 5-57, December 1956.
10. DesGranges, M. Repetitive Diving Decompression Tables. U.S. Navy Experimental Diving Unit Research Report 6-57, January 1957.
11. Vann, R.D. Decompression Theory and Application. In: P. B. Bennett and D. H. Elliott. eds. The Physiology and Medicine of Diving, Third Edition. London: Bailliere and Tyndall. (In U.S. Best Publishing Co., San Pedro, CA), 1982: Chapter 14.

12. U.S. Navy Diving Manual, Volume 2, Revision 1, July 1981. NAVSEA Publication 0994-LP-001-9020. Superintendent of Documents (Stock No. 008-046-00092-1), U.S. Gov't. Printing Office, Wash., D.C. 20402.
13. Barnard, E.E.P. Fundamental Studies in Decompression from Steady-State Exposure, in: C.J. Lambertsen ed. Underwater Physiology I, Proceedings From the Fifth Symposium on Underwater Physiology. Bethesda: Federation of American Societies for Experimental Biology, 1976: 263-271.
14. Hennessy, T.R. and H.V. Hempleman. An Examination of the Critical Released Gas Volume Concept in Decompression Sickness. Proc. R. Soc. Lond. B. 1977; 197:299-313.
15. Spaur, W.H., E.D. Thalmann, E.T. Flynn, J.L. Zumrick, T.W. Reedy, and J.M. Ringleberg. Development of Unlimited Duration Excursion Tables and Procedures for Helium-Oxygen Saturation Diving. Undersea Biomed. Res. 1978; 5(2):159-177.
16. Van Liew, H. Factors in the Resolution of Tissue Gas Bubbles, In: C. J. Lambertsen, ed. Proceedings of the Third Symposium on Underwater Physiology. Baltimore: Williams and Wilkins, 1967: 191-204.

APPENDIX A

**Derivation of MK 15/16 0.7 ATA Fixed PO₂
in Nitrogen Decompression Model Gas Uptake And
Elimination Equations**

INTRODUCTION

The MK 15 Decompression Model evolved in two phases. The first phase was the so called Exponential-Exponential or E-E Model. In principle, this is the model which had been used to compute existing U.S. Navy Air Tables. The concepts of the E-E Model have been well documented and appropriate references are cited in Reference 1 of the main text. This model was used in Phase I of the MK 15 Decompression Algorithm development and assumes gas always remains in solution and that gas uptake and elimination are described as exponential functions. The E-E Model was eventually discarded in favor of the Exponential-Linear or E-L Model. In this model, gas uptake remains exponential but during desaturation offgassing becomes linear when tissue tension exceeds ambient pressure. Derivation of the E-E Model will be discussed first followed by derivation of the E-L Model.

EXPONENTIAL-EXPONENTIAL (E-E) MODEL

The body is assumed to be mathematically equivalent to 9 tissues, each one distinguished from the other by the blood flow per unit volume (\dot{Q}/V). These tissues are not necessarily anatomically distinguishable and the same anatomical regions of the body may be composed of several of these tissues. Each of these tissues is assumed to take up and give off gas independently of each other and to be well stirred, that is the gas concentration is the same throughout. It is further assumed in the E-E Model that arterial and inspired oxygen tension are the same. Conceptually, the E-E Model is presented in the top portion of Fig. A-1. Using a mass balance equation, the rate of accumulation of gas in any tissue at any given time is the difference between the rate at which gas enters and leaves the compartment:

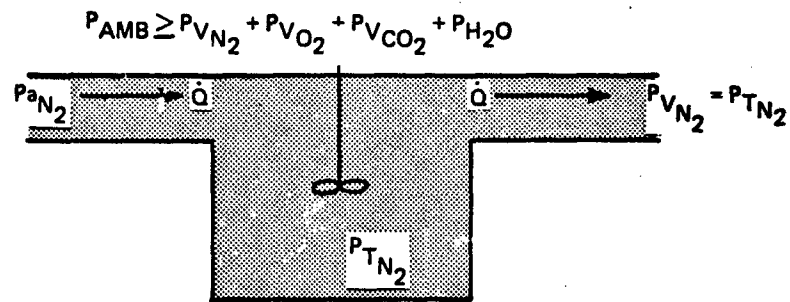

$$P_{TN_2} = P_{aN_2} + (P_{TN_2} - P_{aN_2}) e^{-KT}$$

No Gas Phase Present

$$P_{aN_2} = P_{AMB} - (P_{aO_2} + P_{aCO_2} + P_{H_2O})$$

$P_{aCO_2}, P_{VCO_2}, P_{VO_2}, P_{H_2O}$ Constant

$$K = \left(\frac{\sigma_{BN_2}}{\sigma_{TN_2}} \right) \cdot \left(\frac{\dot{Q}}{V} \right)$$

Gas Phase Present

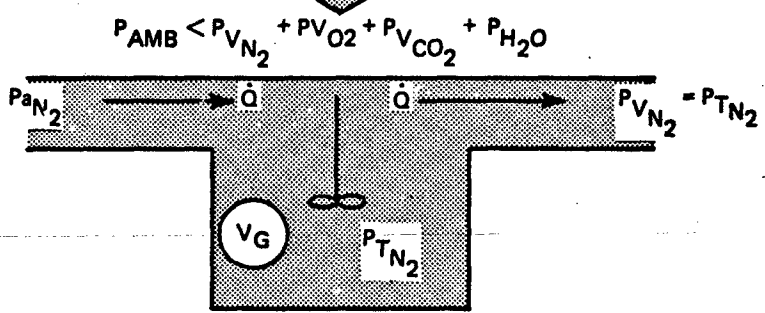

$$P_{TN_2} = P_{AMB} - (P_{VO_2} + P_{VCO_2} + P_{H_2O})$$

$$V_G = V_{Gi} - \sigma_{BN_2} \left(\frac{\dot{Q}}{V} \right) (P_{VN_2} - P_{aN_2}) T$$

$$P_{TN_2} = V_G / \sigma_{TN_2} = P_{TiN_2} - K (P_{VN_2} - P_{aN_2}) T$$

FIGURE A-1. Conceptual representation of gas uptake and elimination equations. The E-E Model uses the scheme in the top of the figure in which there is no gas phase for gas uptake or elimination. The E-L Model uses the scheme in the top portion for gas uptake and the lower scheme for gas elimination, where a gas phase is present when total tissue gas tension exceeds ambient. SEE TEXT FOR SYMBOL DEFINITIONS.

$$(1-A) \quad \dot{V} = (C_a - C_v) \cdot \dot{Q}$$

where:

C_a = arterial gas concentration

C_v = venous gas concentration

\dot{Q} = blood flow per unit tissue volume

\dot{V} = rate of gas accumulation

Gas concentration can be related to partial pressure by Henry's law:

$$(2-A) \quad C = P \cdot \sigma$$

where:

P = partial pressure

σ = solubility

Substituting this into Equation 1-A:

$$(3-A) \quad \dot{V} = (P_{a_{N_2}} - P_{v_{N_2}}) \cdot \sigma_{B_{N_2}} \cdot \dot{Q}$$

where:

$P_{a_{N_2}}$ = arterial nitrogen partial pressure

$P_{v_{N_2}}$ = venous nitrogen partial pressure

$\sigma_{B_{N_2}}$ = blood nitrogen solubility

The rate of gas volume accumulation can be written as a rate of partial pressure change times tissue solubility. Furthermore, the tissue partial pressure ($P_{T_{N_2}}$) and venous partial pressure ($P_{v_{N_2}}$) are assumed to be the same so Equation 3-A becomes:

$$\dot{P}_{T_{N_2}} \cdot \sigma_{T_{N_2}} = (P_{a_{N_2}} - P_{T_{N_2}}) \cdot \sigma_{B_{N_2}} \cdot \dot{Q}$$

rearranging:

$$(4-A) \quad \dot{P}_{T_{N_2}} = (P_{a_{N_2}} - P_{T_{N_2}}) (\sigma_{B_{N_2}} / \sigma_{T_{N_2}}) \cdot \dot{Q}$$

where:

$\dot{P}_{T_{N_2}}$ = rate of change of tissue or venous nitrogen partial pressure

$P_{T_{N_2}}$ = tissue or venous nitrogen partial pressure

$\sigma_{T_{N_2}}$ = tissue nitrogen solubility

Now assume that the arterial inert gas partial pressure changes linearly:

$$(5-A) \quad P_{a_{N_2}} = P_{ai_{N_2}} + R_{N_2} \cdot T$$

$P_{ai_{N_2}}$ = arterial inert gas pressure at start of depth change

R_{N_2} = rate of inert gas partial pressure change

T = time from beginning of depth change

Substituting Equation 5-A into Equation 4-A:

$$(6-A) \quad \dot{P}_{T_{N_2}} = (P_{ai_{N_2}} + R_{N_2} \cdot T - P_{T_{N_2}}) \cdot K$$

where

$$K = (\sigma_{B_{N_2}} / \sigma_{T_{N_2}}) \cdot \dot{Q}$$

Equation 6-A is a first order linear differential equation which can be solved using an integrating factor. The solution is:

$$(7-A) \quad P_{T_{N_2}} = P_{ai_{N_2}} \cdot (1 - e^{-K \cdot T}) + P_{Ti_{N_2}} \cdot e^{-K \cdot T} + R_{N_2} \cdot T + (R_{N_2} / K)(e^{-K \cdot T} - 1)$$

where:

$$P_{Ti_{N_2}} = \text{initial tissue or venous nitrogen tension}$$

If the inert gas partial pressure is changed as a step function, R_{N_2} will be 0 and Equation 7-A will become (with rearranging):

$$(8-A) \quad P_{T_{N_2}} = P_{a_{N_2}} + (P_{Ti_{N_2}} - P_{a_{N_2}}) \cdot e^{-K \cdot T}$$

with the arterial nitrogen tension after the step change ($P_{a_{N_2}}$) being substituted for $P_{ai_{N_2}}$.

It is Equation 8-A which is used to represent gas uptake and elimination for each tissue in the real time E-E algorithm. $P_{T_{N_2}}$ is evaluated at 2 sec intervals and becomes the value of $P_{Ti_{N_2}}$ for the next iteration. Thus, the dive is approximated as a series of 2 second "stairs" each having an instantaneous depth change. Equation 7-A is used to compute the gas tensions for linear ascents and descents and was used to compute decompression tables in Appendix D as described in Reference 5.

EXPONENTIAL-LINEAR (E-L) MODEL

In the E-L Model, gas uptake is described by Equation 7A for linear ascents or descents or Equation 8-A for a step change. However, in the E-L Model, the arterial inert gas tension and inspired inert gas tension are not equal, but rather:

$$(9-A) \quad P_{a_{N_2}} = P_{AMB} - P_{a_{O_2}} - P_{a_{CO_2}} - P_{H_2O}$$

where:

$P_{a_{CO_2}}$ = arterial CO₂ tension

$P_{a_{O_2}}$ = arterial O₂ tension

P_{H_2O} = water vapor tension

Arterial O₂ tension is assumed equal to inspired O₂ tension and arterial CO₂ tension assumed constant throughout the dives.

Venous and tissue gas tensions are assumed equal as in the E-E model. It is assumed that no supersaturation can take place and that whenever the total venous (or tissue) gas tension exceeds ambient, gas will come out of solution. Thus, a gas phase will form whenever;

$$P_{v_{O_2}} + P_{v_{CO_2}} + P_{v_{N_2}} + P_{H_2O} > P_{AMB}$$

or;

$$(10-A) \quad P_{v_{N_2}} > P_{AMB} - (P_{v_{O_2}} + P_{v_{CO_2}} + P_{H_2O})$$

where:

$P_{v_{O_2}}$ = venous or tissue oxygen partial pressure

$P_{v_{CO_2}}$ = venous or tissue carbon dioxide partial pressure

Both $P_{v_{O_2}}$ and $P_{v_{CO_2}}$ are assumed to be constant and independent of depth or arterial gas tension.

Once gas comes out of solution and a gas phase forms, diffusion between the gas phase and surrounding tissue is assumed to be instantaneous and the pressure inside of the gas phase exactly equal to ambient hydrostatic

pressure. This means that once the gas phase forms, its volume may change but the total tissue gas tension will never exceed ambient. While the gas phase exists, its volume will change according to the arterial venous difference in inert gas times the blood flow, that is:

$$(11-A) \quad \dot{V}_G = \sigma_{B_{N_2}} (P_{a_{N_2}} - P_{v_{N_2}}) \cdot \dot{Q}$$

where:

\dot{V}_G = rate of volume change of gas phase

$P_{a_{N_2}}$ = arterial nitrogen tension

$P_{v_{N_2}}$ = venous or tissue nitrogen tension

$\sigma_{B_{N_2}}$ = blood nitrogen solubility

\dot{Q} = blood flow per unit tissue volume

Since arterial gas tensions always add up to total ambient pressure:

$$(12-A) \quad P_{a_{N_2}} = P_{AMB} - (P_{a_{O_2}} + P_{a_{CO_2}} + P_{H_2O})$$

for venous or tissue inert gas tension:

$$(13-A) \quad P_{v_{N_2}} = P_{AMB} - (P_{v_{O_2}} + P_{v_{CO_2}} + P_{H_2O})$$

Substituting Equations 12 and 13 into equation 11:

$$\dot{V}_G = \sigma_{B_{N_2}} \cdot [(P_{v_{O_2}} + P_{v_{CO_2}} - P_{a_{CO_2}}) - P_{a_{O_2}}] \cdot \dot{Q}$$

In this model, it is assumed that inspired and arterial oxygen tension are equal, that is, $P_{I_{O_2}} = P_{a_{O_2}}$. Making this substitution:

$$(14-A) \quad \dot{V}_G = \sigma_{B_{N_2}} \cdot [(P_{v_{O_2}} + P_{v_{CO_2}} - P_{a_{CO_2}}) - P_{I_{O_2}}] \cdot \dot{Q}$$

The assumption that arterial and inspired oxygen tensions are equal is an oversimplification. A more exact representation of arterial oxygen tension is based on the alveolar gas equation¹:

$$P_{aO_2} = P_{iO_2} - \{P_{ACO_2}/R - F + AaDO_2\}$$

where:

$$P_{ACO_2} = \text{alveolar } CO_2 \text{ tension}$$

$$F = P_{ACO_2} \cdot F_{iO_2} \cdot (1-R)/R$$

$$R = \text{respiratory quotient}$$

$$AaDO_2 = \text{alveolar-arterial oxygen difference}$$

The terms in () brackets are depth independent and come to approximately 50 mmHg. Ignoring these terms will over estimate P_{aCO_2} by 50 mmHg which will over estimate the rate of inert gas elimination in Equation 14-A. In the context of all the other assumptions made in deriving the E-L Model, assuming the $P_{iO_2} = P_{aO_2}$ was considered justified in this early phase of development.

At this point, it is useful to pull a little mathematical slight of hand. The left hand portion of equation 14-A represents a volume change. However, this volume could be represented by the product of solubility and partial pressure. This tissue partial pressure (" $P_{T_{N_2}}$ ") would conceptually

¹ See page 166 of West, J.B. Respiration Physiology, Williams and Wilkins, Baltimore, MD, 1974.

be that which would result if the inert gas phase were forced into solution.

Making this substitution:

$$\sigma_{T_{N_2}} \cdot \dot{P}_{T_{N_2}} = \sigma_{B_{N_2}} \cdot [(P_{V_{O_2}} + P_{V_{CO_2}} - P_{a_{CO_2}}) - P_{I_{O_2}}] \cdot \dot{Q}$$

where:

$$\sigma_{T_{N_2}} = \text{tissue nitrogen solubility}$$

and rearranging:

$$(15-A) \quad \dot{P}_{T_{N_2}} = [(P_{V_{O_2}} + P_{V_{CO_2}} - P_{a_{CO_2}}) - P_{I_{O_2}}] (\sigma_{B_{N_2}} / \sigma_{T_{N_2}}) \cdot \dot{Q}$$

Now the term $(\sigma_{B_{N_2}} / \sigma_{T_{N_2}}) \cdot \dot{Q}$ is the exponential time constant K in the gas equation (see equation 6-A). Also, while equation 15-A is a differential equation its solution is simple for a constant inspired oxygen tension and is:

$$(16-A) \quad P_{T_{N_2}} = P_{Ti_{N_2}} + [(P_{V_{O_2}} + P_{V_{CO_2}} - P_{a_{CO_2}}) - P_{I_{O_2}}] \cdot K \cdot T$$

where

$$K = (\sigma_{B_{N_2}} - \sigma_{T_{N_2}}) \cdot \dot{Q}$$

T = Time from start of depth change

$P_{I_{N_2}}$ = starting tissue nitrogen tension

Equation 16-A is applicable to a step change or linear depth change since the rate of gas elimination is independent of depth.

Note that once the gas phase forms that the rate of inert gas elimination in Equation 15-A is independent of ambient pressure and a function only of inspired oxygen tension. In the MK 15 and MK 16 closed circuit UBAs the oxygen partial pressure is constant so the rate of gas elimination is constant. If one were breathing air where the inspired oxygen tension changes with depth, Equation 15-A predicts that inert gas elimination will be greater at increased depth. If a linear depth change occurs and the breathing gas is a fixed fraction of oxygen, then $P_{I_{O_2}}$ will not be constant but will be:

$$(17-A) \quad P_{I_{O_2}} = F_{I_{O_2}} \cdot (P_{AMB1} + R_D \cdot T)$$

where:

P_{AMB1} = ambient pressure at start of depth change

R_D = rate of depth change

$F_{I_{O_2}}$ = oxygen fraction of inspired gas

T = time from start of depth change

Substituting this into Equation 15-A:

$$"P_{T_{N_2}}" = [(P_{V_{O_2}} + P_{V_{CO_2}} - P_{a_{CO_2}}) - F_{I_{O_2}} \cdot P_{AMB1} - F_{I_{O_2}} \cdot R_D \cdot T] \cdot K \cdot T$$

which is a linear differential equation, the solution of which is:

$$(18-A) \quad "P_{T_{N_2}}" = P_{T_{N_2}} + [(P_{V_{O_2}} + P_{V_{CO_2}} - P_{a_{CO_2}}) - F_{I_{O_2}} \cdot P_{AMB1}] \cdot K \cdot T - (K \cdot F_{I_{O_2}} \cdot R_D / 2) \cdot T^2$$

² Rigorously the difference $P_{AMB1} - P_{H_2O}$ should be used instead of just P_{AMB1} in Equation 17-A. However, as P_{AMB1} increases the effect of this omission is minimized.

Note that the product $F_{I_{O_2}} \cdot P_{AMB}$ is the oxygen partial pressure at the beginning of the depth change and $F_{I_{O_2}} \cdot R_D$ is the rate of oxygen partial pressure change. Making these substitutions:

$$(19-A) \text{ "P}_{T_{N_2}} \text{ " = P}_{T_{N_2}} + [(P_{V_{O_2}} + P_{V_{CO_2}} - P_{a_{CO_2}}) - P_{ai_{O_2}}] \cdot K \cdot T - (K \cdot R_{O_2} / 2) \cdot T^2$$

where:

$$P_{ai_{O_2}} = F_{I_{O_2}} \cdot P_{AMB_0} = \text{initial arterial oxygen tension}$$

$$R_{O_2} = F_{I_{O_2}} \cdot R_D = \text{rate of oxygen partial pressure change}$$

For a constant P_{O_2} , R_{O_2} is equal to 0, $P_{ai_{O_2}}$ equals $P_{a_{O_2}}$, and Equation 19-A reduces to equation 16-A. Also, for a step change in depth, R_{O_2} equals 0 and Equation 16-A can be used.

To summarize, the E-L Model uses the exponential gas uptake Equation 7-A (or 8-A for a step change) and uses Equation 9-A to compute arterial inert gas tension. During tissue offgassing, equation 7-A (or 8-A for a step change) will describe desaturation as long as total tissue gas tension is less than ambient. When total tissue gas tension equals ambient, equation 10-A is satisfied and desaturation will be described by equation 16-A for a constant oxygen partial pressure or equation 19-A for a constant oxygen fraction.

Figure A-1 summarizes the E-L Model. Note that the equations in Figure A-1 are for a step change in ambient pressure. The top portion of Figure A-1 shows the situation when $P_{AMB} \geq P_{v_{N_2}} + P_{v_{O_2}} + P_{v_{CO_2}} + P_{H_2O}$. This is a well stirred compartment with no gas phase. When $P_{AMB} < (P_{v_{N_2}} + P_{v_{O_2}} + P_{v_{CO_2}} + P_{H_2O})$ a gas phase forms and the situation becomes that pictured in the bottom of Figure A-1. Here a gas phase with volume V_G forms in the well stirred compartment which is in instantaneous diffusion equilibrium with the fluid in the compartment. The total gas tension inside the gas phase always equals ambient so that as depth decreases the gas tension will not increase but the physical size of the volume V_G will.

Figure A-2 graphs the changes in gas tension for a step change in ambient pressure. This graph illustrates the situation when the P_{O_2} is constant and only the change in arterial nitrogen tension ($P_{a_{N_2}}$) is shown. $P_{a_{N_2}}$ is related to the ambient partial pressure by Equation 9-A and since $P_{a_{O_2}}$ and $P_{a_{CO_2}}$ are constant, $P_{a_{N_2}}$ and P_{AMB} will always differ by a constant amount. In Figure A-2, at time 0, $P_{a_{N_2}}$ increases instantaneously from P_1 to P_2 and remains at P_2 until time T_0 . The solid line shows the exponential gas uptake which occurs in the tissue. At time T_0 , $P_{a_{N_2}}$ instantaneously decreases from P_2 to P_1 . Note that after time T_0 , the venous nitrogen tension, $P_{v_{N_2}}$, exceeds $P_{a_{N_2}}$. This amount is constant and can be found by substituting equation 12-A into equation 13-A to get:

$$P_{v_{N_2}} = P_{a_{N_2}} + (P_{a_{O_2}} + P_{a_{CO_2}}) - (P_{v_{O_2}} + P_{v_{CO_2}})$$

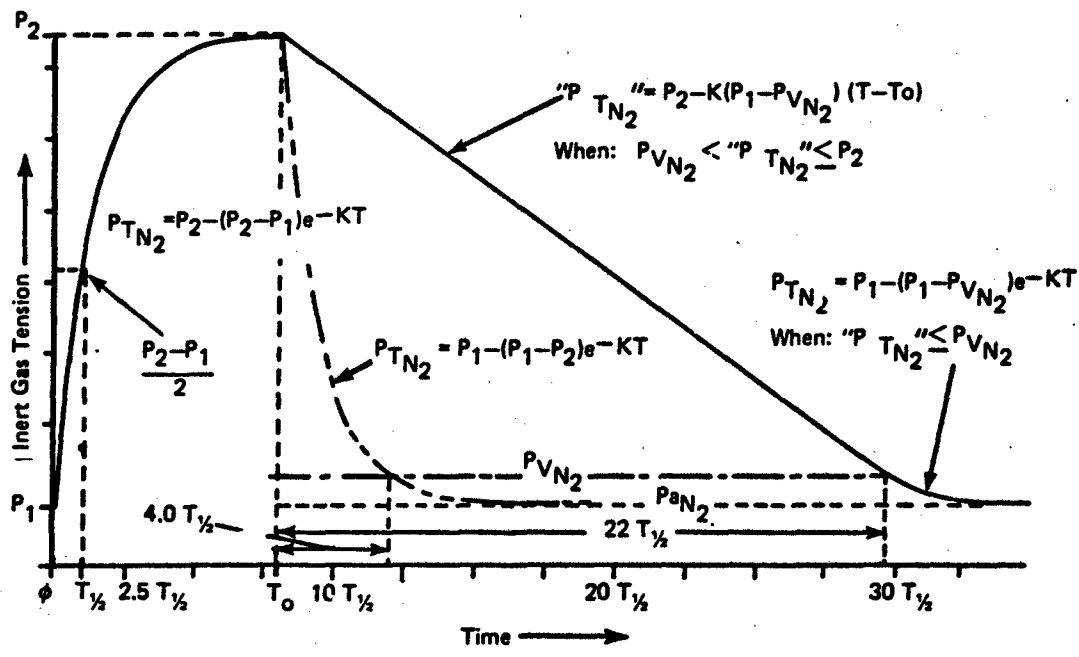

FIGURE A-2. Graphic representation of tissue gas tension for a step change in depth. At time 0, depth increases causing arterial inert gas tension (P_{aN_2}) to decrease from P_1 to P_2 . The solid line decreases causing P_{aN_2} to decrease from P_2 to P_1 . The solid line shows tissue gas tension changes according to the E-L Model. The dash line shows tissue gas tension decrease according to the E-E Model. The difference $P_2 - P_1$ is exactly 16 times the difference $P_{vN_2} - P_{aN_2}$ and corresponds to a downward depth excursion of 66 FSW breathing a 0.21 ATA PO_2 gas and 324 FSW if breathing a 0.7 ATA PO_2 gas.

for a $P_{I_{O_2}}$ of 0.7 ATA the arterial tensions will also be 0.7 ATA or expressed in FSW, $P_{a_{O_2}} = 23.1$ FSW. $P_{a_{CO_2}}$, $P_{v_{O_2}}$ and $P_{v_{CO_2}}$ are assumed constant and independent of both depth and $P_{a_{O_2}}$ and are 1.5, 2.0 and 2.3 FSW respectively. Thus:

$$P_{v_{N_2}} = P_{a_{N_2}} + 20.30 \text{ FSW.}$$

This 20.30 FSW arterial-venous nitrogen tension difference is the driving force for inert gas elimination. The actual venous nitrogen tension will fall from P_2 to $P_{v_{N_2}}$ and stay at $P_{v_{N_2}}$ until the entire gas phase is eliminated. The gas phase volume is represented by the dissolved gas tension " $P_{T_{N_2}}$ " and this falls linearly according to Equation 16-A. When the dissolved tension " $P_{T_{N_2}}$ " equals the venous inert gas tension then the gas phase has been eliminated and the tissue tension will fall from $P_{v_{N_2}}$ to $P_{a_{N_2}}$ exponentially. The double-short/single-long dashed line in Fig. A-2 represents the tissue tension decrease if no inert gas is assumed to form, that is if the E-E Model describes offgassing. Note how much faster gas is eliminated if exponential elimination is assumed than if linear elimination is assumed. This marked assymetry is the main feature of the E-L Model.

In Figure A-2 the ratio between the time it takes tissue inert gas tension to reach $P_{v_{N_2}}$ according to the E-L and E-E Model is 22/4.0 or 5.5. This ratio of times (R) can be expressed in general as:

$$R = (A-1)/LN(A)$$

where:

$$A = (P_2 - P_{a_{N_2}}) / (P_{v_{N_2}})$$

* FSW is used to express gas tensions. 33 FSW = 1 ATA = 760 mmHg.

The above equation shows that the increase in offgassing time of the E-L over the E-E Model becomes greater as P_2 gets larger.

The E-L Decompression Model has several inconsistencies and simplifying assumptions. As has been pointed out, assuming $P_{I_{O_2}} = P_{a_{O_2}}$ will cause inert gas elimination rates to be over estimated, and the percentage error will be larger for lower values of $P_{I_{O_2}}$. Another assumption which has been made is that the arterial-venous inert gas tension is independent of arterial oxygen tension. This of course cannot hold over a wide range of arterial oxygen tensions because the hemoglobin dissociation is not linear but sigmoid shaped. These simplifying assumptions were made for the sake of mathematical expediency, their consequences remain to be determined.

APPENDIX B
MK 15/16 REAL TIME
ALGORITHM ERROR ANALYSIS

The basis of the MK 15/16 RTA are Equation 1 and 3 of the main text which are iterated every 2 seconds (Figures 3 and 4 of the main text). If all variables in Equations 1 and 3 of the main text could be represented exactly, no error would accumulate but such is not the case. The HP 1000 Computer used to compute the real time profiles in this report represents single precision numbers as a 23 bit fraction to a relative accuracy of $1/2 \cdot 2^{-23}$ or $\pm 1.19 \cdot 10^{-7}$. This value is called the machine unit, u. For each of the variables in Equations 1 and 3 of the main text, the errors are as follows:

$$P_{a_{N_2}} \pm \epsilon_1$$

$$P_{T1_{N_2}} \pm \epsilon_2$$

$$(e^{-KT}) \pm \epsilon_3$$

$$P_{I_{O_2}} \pm \epsilon_4$$

$$K \pm \epsilon_5$$

$$T \pm \epsilon_6$$

Note that these are all relative errors and must be multiplied by the values of the variables in question to get the absolute errors. Also note that $\epsilon_1 = \epsilon_2 = \epsilon_5 = \epsilon_6 = u$ which means that the error involved for the associated variables are simply the accuracy to which they can be represented by the computer. The value for $P_{I_{O_2}}$ can be represented exactly, therefore $\epsilon_4 = 0.0$. The error ϵ_3 is the error in exponentiation and for the HP 1000 was found to be equal to $3u$.

Besides the error in representing $P_{a_{N_2}}$ as a floating point number, this variable also has another source of error determined by the accuracy of

the pressure transducer which measures the depth. This error may or may not be a function of depth but will be represented as an absolute error δ_1 which will be at least ± 1 FSW. Since ϵ_1 is $\pm 1.19 \cdot 10^{-7}$, δ_1 will predominate so the proper representation for the arterial inert gas tension will be:

$$P_{a_{N_2}} \pm \delta_1$$

Taking these errors into account, Equation 3 of the main text becomes:

$$(1-B) \quad P_{T_{N_2}} = (P_{T_{i_{N_2}}} + \epsilon_1 \cdot P_{T_{i_{N_2}}}) + [2.8 - P_{I_{O_2}}](K + \epsilon_5 \cdot K)(T + \epsilon_6 \cdot T)$$

Expanding this equation and rearranging terms, one obtains:

$$(2-B) \quad P_{T_{N_2}} = \{P_{T_{i_{N_2}}} + [2.8 - P_{I_{O_2}}] \cdot K \cdot T\} + \epsilon_1 \cdot P_{T_{i_{N_2}}} + [2.8 - P_{I_{O_2}}] K \cdot T \cdot (\epsilon_2 + \epsilon_3 + \epsilon_2 \cdot \epsilon_3)$$

The term $\epsilon_2 \cdot \epsilon_3$ will be seven orders of magnitude smaller than other terms and can be ignored. The terms in { } are the ones in Equation 3 of the main text and all other terms represent the error. Thus, the absolute error in computing $P_{T_{N_2}}$ is:

$$(3-B) \quad P_{T_{N_2}} = \{P_{T_{i_{N_2}}} + [2.8 - P_{I_{O_2}}] \cdot K \cdot T\} \pm e_1$$

where:

$$(4-B) \quad e_1 = \epsilon_1 \cdot P_{T_{i_{N_2}}} + [2.8 - P_{I_{O_2}}] \cdot K \cdot T \cdot (\epsilon_2 + \epsilon_3)$$

This error will accumulate with each iteration of Equation 3 as the computed value of $P_{T_{N_2}}$ is used as the value of $P_{T_{i_{N_2}}}$ for the following iteration. The worst case situation is that each error resulting from an iteration is the same sign so that the total cumulative error after N iterations will be $N \cdot e_1$. However, the signs of ϵ_1 , ϵ_5 and ϵ_6 will vary

randomly so that a more reasonable representation of the total cumulative error will be $\sqrt{N \cdot e_1}$. The maximum value of $P_{T_1 N_2}$ which would be encountered is $3 \cdot 10^2$ FSW. The value of $P_{I_{0_2}}$ is 23.1 FSW (0.7 ATA), T is 2 sec and the largest value for the exponential time constant K would be $(\ln 2)/5$ or 0.139. Over a 24 hour period, the maximum number of 2 sec iterations is 43,200 so that the maximum cumulative error for linear updates would be:

$$E_{Lin} < \sqrt{43,200} \{ (1.19 \cdot 10^{-7}) [3 \cdot 10^2 + |2.8 - 23.1| \cdot 0.139 \cdot (2.60)] \}$$

or:

$$E_{Lin} < 0.007 \text{ FSW}$$

Notice that the value (2.8-23.1) is negative but the absolute value is used in computing the error E_{Lin} .

The situation for the exponential Equation 2 of the main report is more complicated. If Equation 1 of the main text is iterated at a constant depth, the only errors which will accumulate will be computer roundoff errors. However, during linear depth changes Equation 1 of the main text is not an exact representation of gas uptake and elimination. The exact representation is Equation 7-A in Appendix A. If Equation 1 of the main text is subtracted from Equation 7-A of Appendix A, the resultant difference in terms (δ_4) will be:

$$(5-B) \quad \delta_4 = R \cdot T + (R/K)(e^{-K \cdot T} - 1)$$

¹ - Numerical Methods, G. Dahlquist and Ake Bjorck, Prentice Hall, Englewood Cliffs, N.J., 1974.

Thus, δ_4 represents the error in approximating a linear depth change with a series of instantaneous step changes of 2 sec duration. Taking all source of errors into account, the inert gas tension as computed by Equation 1 of the main text will be:

$$(3-B) \quad P_{T_1} = (P_{a_0} + \delta_1) + (P_{T_0} + \epsilon_2 \cdot P_{T_0} - P_{a_0} - \delta_1) [e^{-K \cdot T} (1 + \epsilon_3)] + \delta_4$$

where:

P_{a_0} = initial value of $P_{a_i N_2}$

P_{T_0} = initial value of $P_{T_i N_2}$

P_{T_1} = first computed value for tissue tension

δ_1 = absolute error in P_{a_0}

ϵ_2 = relative error in P_{T_0}

ϵ_3 = relative error in $e^{-K \cdot T}$

δ_4 = error in approximating linear depth change with a "staircase"

While the signs of ϵ_2 and ϵ_3 will vary randomly depending on the values of P_{T_0} and e^{-KT} , δ_1 will usually not change sign but will always be positive or negative. Therefore, the error in P_{a_0} will not be the absolute value of δ_1 but the signed value. If equation 3-B is expanded and all terms containing $\epsilon_2 \cdot \epsilon_3$ and $\epsilon_3 \cdot \delta_1$ are ignored (since they will be several orders of magnitude smaller than all the other terms) one obtains:

$$(7-B) \quad P_{T_1} = P_{a_0} + (P_{T_0} - P_{a_0})e^{-K \cdot T} + e_1$$

where the error e_1 is:

$$(8-B) \quad e_1 = \delta_1 \cdot (1 - e^{-KT}) + P_{T_0} (\epsilon_3 + \epsilon_2 \cdot e^{-KT}) - \epsilon_3 \cdot P_{a_0} \cdot e^{-K \cdot T} + \delta_4$$

where δ_4 is given by equation 5-B.

During the next iteration of Equation 6-B, the value for P_{T_1} will be substituted for P_{T_0} and the next arterial inert gas tension, P_{a_1} , will be substituted for P_{a_0} and the resultant inert gas tension will be P_{T_2} . The value for P_{T_1} will have already accumulated an error e_1 from the first iteration so if P'_{T_1} is defined as the exact value of the tissue tension then:

$$P_{T_1} = P'_{T_1} + e_1$$

If this substitution is made for the values of P_{T_1} in Equation 6-B and all $\epsilon_3 \cdot \epsilon_2$, $\epsilon_3 \cdot \delta_1$, $e_1 \cdot \epsilon_3$, and $e_1 \cdot \epsilon_2$ terms are ignored so the resulting expression will be:

$$P_{T_2} = P_{a_1} + (P'_{T_1} - P_{a_1})e^{-K \cdot T} + e_2$$

where:

$$e_2 = \delta_1 \cdot (1 - e^{-2 \cdot K \cdot T}) + (\epsilon_3 + \epsilon_2 \cdot e^{-K \cdot T})(P'_{T_1} + P_{T_0} \cdot e^{-K \cdot T}) - \epsilon_3 (P_{a_1} \cdot e^{-K \cdot T} + P_{a_0} \cdot e^{-2 \cdot K \cdot T}) + \delta_4 (1 + e^{-K \cdot T})$$

If this process is continued it can be shown that the absolute error after N iterations will be:

$$e_N = \delta_1 \cdot (1 - e^{-N \cdot K \cdot T}) + (\epsilon_3 + \epsilon_2 \cdot e^{-K \cdot T}) \cdot \sum_{i=0}^{N-1} (P'_{T_{N-1-i}} + P_{T_0} \cdot e^{-i \cdot K \cdot T}) - \epsilon_3 \cdot e^{-K \cdot T} \cdot \sum_{i=0}^{N-1} (P_{a_{N-1-i}} \cdot e^{-i \cdot K \cdot T}) + \delta_4 \cdot \sum_{i=0}^{N-1} e^{-i \cdot K \cdot T}$$

Since T is 2 seconds, the value $e^{-K \cdot T}$ will be very close to 1.0 so the above equation simplifies to:

$$e_N < \delta_1 \cdot (1 - e^{-N \cdot K \cdot T}) + (\epsilon_3 + \epsilon_2) \cdot \sum_{i=0}^{N-1} P'_{T_N} - \epsilon_3 \cdot \sum_{i=0}^{N-1} P_{a_N} + N \cdot \delta_4$$

Since:

$$\sum_{i=0}^{N-1} P'_{T_N} < N \cdot P_{T_{\max}}$$

and:

$$\sum_{i=0}^{N-1} P_{a_N} < P_{a_{\max}}$$

where $P_{T_{\max}}$ and $P_{a_{\max}}$ are the largest expected values of tissue tension and arterial inert gas tension then:

$$e_N < \delta_1 \cdot (1 - e^{-N \cdot K \cdot T}) + N \cdot (\epsilon_3 + \epsilon_2) \cdot P_{T_{\max}} + \epsilon_3 \cdot N \cdot P_{a_{\max}} + N \cdot \delta_4$$

As N increases, $e^{-N \cdot K T}$ approaches 0.0 and the term $(1 - e^{-N \cdot K T})$ approaches 1.0. This is the worst case assumption and if it is made then:

$$(8-B) \quad e_N < 1 + N (\epsilon_2 + \epsilon_3) P_{T_{\max}} + 3 N P_{a_{\max}} + N \epsilon_4$$

The error estimate made using equation 8-B will be very conservative since for the small values of $e^{-K T}$ used in the MK 15/16 RTA the term $(1 - e^{-N \cdot K T})$ will be substantially less than 1.0 for the first few hundred iterations. On the HP 1000 Computer, the value of ϵ_2 will be $1.19 \cdot 10^{-7}$ and the value of ϵ_3 some three times larger. If one assumes maximum values of 300 FSW for $P_{T_{\max}}$ and $P_{a_{\max}}$ then:

$$e_N < 1 + N 1.785 \cdot 10^{-4} + N \epsilon_4$$

As previously mentioned, the signs of ϵ_2 and ϵ_3 will vary randomly so the error involving ϵ_2 and ϵ_3 will accumulate as the square root of the number of iterations. Over a 24 hr period, there will be 43,200 iterations and $N = \sqrt{43,200}$ or approximately 207.0. Thus:

$$(9-B) \quad e_N < 1.037 + N \cdot \epsilon_4$$

In the above equation only the error ϵ_4 remains to be evaluated. Since ϵ_4 will always have the same sign for ascents and descents, its sign does not vary randomly and the cumulative error will accumulate as the actual number of iterations. However, if depth is not changing, $\epsilon_4 = 0.0$. For depth changes:

(10-B) Number iterations = $\Delta D / (R \cdot T)$

where:

ΔD = depth change

R = rate of depth change

T = time increment for each iteration (2 sec)

Thus, the cumulative error is found by multiplying the right hand side of Equation 5-B by the right hand side of Equation 10-B;

$$\text{Cumulative Error} = N \cdot \delta_4 = \Delta D \cdot [1 + (e^{-K \cdot T} - 1) / (K \cdot T)]$$

The term in parenthesis is the cumulative error per foot of depth change and the value for each of the halftime tissues is shown in Table B-1.

Table B-1									
Cumulative Error (FSW) Per Foot of Depth Change									
Tissue Halftime	5	10	20	40	80	120	160	200	240
Cum. Error/FSW (multiply all values by 10^{-3})	2.31	1.15	0.577	0.288	0.144	0.097	0.072	0.057	0.048

The errors shown in Table B-1 will only apply for exponential gas uptake and elimination. During ascents and descents the maximum error will occur immediately upon arrival at the new depth. As gas uptake or offgassing occurs at a constant depth, the error will decrease exponentially and approach 0. The error in the 5 min tissue after a 100 FSW depth change will be 0.23 FSW but this error will have halved to 0.12 FSW in 5 min and decreased to 0.06 in 10 min. Also, the error is signed and during descent (positive ΔD) the MK 15/16 RTA will over estimate the tissue tension and during ascents it will underestimate it. Since the number of descents and ascents in a dive are equal, many of the errors will cancel out. From a practical standpoint the largest single depth excursion which would be made is certainly no larger than 300 FSW and the maximum error which would occur would be 0.69 FSW in the 5 min tissue. This error is still below the ± 1 FSW accuracy of depth measurement and the accuracy of the calculation would not change significantly if it were smaller. The total error in estimating tissue tension from Equation 9-B would be $1.037 + 0.69$ or approximately 2 FSW.

The worst case error of 2 FSW will occur if the accuracy of the pressure transducer is ± 1 FSW and if no cancellation of the δ_4 error (Equation 9-B) occurs. The amount of time it would take each tissue to decrease 2 FSW assuming linear offgassing (Equation 3 of the main text) is 0.71 min for the 5 min tissue and 34.14 min for the 240 min tissue. Most dives, however, will be controlled by the 40 min or 80 min tissues leading to maximum total decompression time differences of 5.7 to 11.4 min. The fact that most of the errors cancel out is demonstrated when one compares a profile computed with program DMDR7 (reference 5 of main text) with a profile computed in real time using the MK 15/16 RTA. A profile in which one descends to 150 FSW for 15 min, decompresses and remains at 1 ATA for 60 min and then does another

150/15 min dive would take exactly 170.13 min using program DMDB7. The MK 15/16 RTA surfaces in 170.03 an error of .11 min. Since the 40 min tissue controlled the final stop this translates into a tissue tension error of 0.039 FSW. Thus, in practice the errors in the MK 15/16 RTA will be much smaller than the theoretical worst case errors.

In summary, the two sources of error in the MK 15/16 RTA, roundoff error, and the error in approximating linear depth changes with a series of step functions, will at the worse approach the ± 1 FSW error made in monitoring the depth. In practice, many of these errors will cancel out leading to relatively insignificant real time errors.

APPENDIX C

DIVE PROFILE COMPARISONS

All times shown in minutes.

Times indicate total time at indicated depth only. All ascents and descents at 60 FPM.

Total times include all stop times plus time required for ascents and descents.

Profile descriptions for Profiles 3-12 in Table 2 of Reference (1).

Profile descriptions for Profiles 20-30 in Table 9 this report.

DIVE PROFILE COMPARISON

PROFILE 3 (150/30)*2 ; 30/120

Stops (FSW)	MVAL5	MVAL83	MVAL92	MVAL97	VVAL09	VVAL14	VVAL18
150	30:00	30:00	30:00	30:00	30:00	30:00	30:00
90	0.58	0.58	0.58	0.58	---	---	---
80	1.52	1.52	1.52	1.52	---	---	---
70	2.94	2.94	2.94	2.94	---	---	---
60	3.56	3.56	3.56	3.56	3.21	---	---
50	3.77	3.77	3.77	3.77	6.94	2.33	2.33
40	7.69	7.69	7.69	7.69	6.94	6.94	6.94
30	120.00	120.00	120.00	120.00	120.00	120.00	120.00
150	30.00	30.00	30.00	30.00	30.00	30.00	30.00
90	0.60	0.60	0.60	0.60	---	---	---
80	1.52	1.52	1.52	1.52	---	---	---
70	3.24	3.24	3.24	3.24	---	---	---
60	3.56	3.56	3.56	3.56	4.24	---	---
50	5.08	5.08	5.08	5.08	6.94	3.37	3.37
40	8.16	8.16	8.16	8.16	11.55	11.18	14.89
30	11.85	11.85	11.85	11.85	22.68	26.28	28.26
20	20.38	23.92	75.68	32.35	54.47	36.73	31.04
10	44.88	62.10	91.51	61.45	63.63	71.31	72.84
TOTAL	308.32	329.08	410.25	336.85	369.60	347.14	348.67

NOTE: NEDU Report 11-80 mistakenly used a 35 min bottom time for computing the Dive Profile 3 on page 2-4 of that report. This accounts for the large discrepancy in stop times between this profile and the one shown here for MVAL5.

DIVE PROFILE COMPARISON
PROFILE 4 (125/30)*3 ; (10/30)*20

Stops (FSW)	MVAL5	MVAL83	MVAL92	MVAL97	VVAL09	VVAL14	VVAL18
125	30.00	30.00	30.00	30.00	30.00	30.00	30.00
70	0.76	0.76	0.76	0.76	---	---	---
60	1.86	1.86	1.86	1.86	---	---	---
50	3.77	3.77	3.77	3.77	---	---	---
40	4.00	4.00	4.00	4.00	1.59	---	---
30	7.44	7.44	7.44	7.44	6.94	0.71	0.71
20	9.24	7.44	7.44	5.61	11.08	10.37	10.85
10	30.00	30.00	30.00	30.00	30.00	30.00	30.00
125	30.00	30.00	30.00	30.00	30.00	30.00	30.00
70	0.75	0.75	0.75	0.75	---	---	---
60	1.80	1.81	1.81	1.82	---	---	---
50	3.77	3.77	3.77	3.77	---	---	---
40	4.00	4.12	4.12	4.24	8.14	2.40	4.47
30	8.67	8.68	8.68	8.68	20.03	24.92	28.26
20	15.48	17.49	32.76	15.91	28.26	28.26	28.26
10	30.00	30.00	30.00	30.00	30.00	30.00	30.00
125	30.00	30.00	30.00	30.00	30.00	30.00	30.00
70	0.75	0.75	0.75	0.75	---	---	---
60	1.78	1.77	1.74	1.77	---	---	---
50	3.77	3.77	3.77	3.77	---	---	---
40	4.00	4.00	4.00	4.00	4.47	2.01	4.47
30	8.39	8.30	7.83	8.37	28.26	28.26	28.26
20	16.34	17.85	59.59	23.82	44.27	31.59	28.26
10	41.27	59.57	86.77	60.74	56.69	60.68	60.84
TOTAL	299.69	319.75	403.45	323.68	371.58	351.05	356.23

DIVE PROFILE COMPARISON

PROFILE 5 (75/30)*5;(10/15)*4

Stops (FSW)	MVAL5	MVAL83	MVAL92	MVAL97	VVAL09	VVAL14	VVAL18
75	30.00	30.00	30.00	30.00	30.00	30.00	30.00
30	1.29	---	---	---	---	---	---
20	4.17	---	---	---	---	---	---
10	15.00	15.00	15.00	15.00	15.00	15.00	15.00
75	30.00	30.00	30.00	30.00	30.00	30.00	30.00
30	1.29	---	---	---	---	---	---
20	4.87	---	---	---	---	---	---
10	15.00	15.00	15.00	15.00	15.00	15.00	15.00
75	30.00	30.00	30.00	30.00	30.00	30.00	30.00
30	1.29	---	---	---	---	---	---
20	5.39	5.42	5.42	3.58	---	---	---
10	15.00	15.00	15.00	15.00	15.00	15.00	15.00
75	30.00	30.00	30.00	30.00	30.00	30.00	30.00
30	1.29	---	---	---	---	---	---
20	5.39	6.34	9.81	5.24	15.00	4.72	10.40
10	15.00	15.00	15.00	15.00	15.00	15.00	15.00
75	30.00	30.00	30.00	30.00	30.00	30.00	30.00
30	1.29	---	---	---	---	---	---
20	5.39	6.34	20.44	5.24	24.47	15.24	10.91
10	24.58	38.68	72.30	43.64	56.69	58.07	57.65
TOTAL	277.40	277.95	329.13	278.87	317.33	299.19	300.12

DIVE PROFILE COMPARISON

PROFILE 6 150/60

Stops (FSW)	MVAL5	MVAL83	MVAL92	MVAL97	VVAL09	VVAL14	VVAL18
150	60.00	60.00	60.00	60.00	60.00	60.00	60.00
100	0.03	0.03	0.03	0.03	---	---	---
90	1.59	1.59	1.59	1.59	---	---	---
80	3.19	3.19	3.19	3.19	---	---	---
70	5.71	5.71	5.71	5.71	13.84	5.31	5.31
60	7.26	7.26	7.26	7.26	14.05	14.05	14.05
50	7.69	7.69	7.69	7.69	17.67	20.52	26.20
40	14.74	14.74	14.74	14.74	28.26	28.26	28.26
30	17.50	17.50	17.50	17.50	29.09	28.26	28.26
20	26.77	30.31	79.27	35.94	56.69	38.54	33.92
10	42.80	60.03	81.89	60.74	64.99	75.14	78.31
TOTAL	192.28	213.05	283.87	219.39	289.59	275.08	279.31

DIVE PROFILE COMPARISON

PROFILE 7 150/45

Stops (FSW)	MVAL5	MVAL83	MVAL92	MVAL97	VVAL09	VVAL14	VVAL18
150	45.00	45.00	45.00	45.00	45.00	45.00	45.00
100	0.01	0.01	0.01	0.01	---	---	---
90	0.76	0.76	0.76	0.76	---	---	---
80	3.17	3.17	3.17	3.17	---	---	---
70	3.36	3.36	3.36	3.36	3.14	---	---
60	5.48	5.48	5.48	5.48	9.51	4.12	4.12
50	7.69	7.69	7.69	7.69	14.05	14.05	14.05
40	8.16	8.16	8.16	8.16	14.05	14.05	17.30
30	15.26	15.26	15.26	15.26	23.07	25.82	28.26
20	18.63	20.40	45.28	18.57	35.36	28.26	28.26
10	33.87	45.77	69.36	50.38	56.69	43.12	38.11
TOTAL	146.38	160.05	208.52	162.82	205.86	179.42	180.10

DIVE PROFILE COMPARISON

PROFILE 8 100/60

Stops (FSW)	MVAL5	MVAL83	MVAL92	MVAL97	VVAL09	VVAL14	VVAL18
100	60.00	60.00	60.00	60.00	60.00	60.00	60.00
50	2.38	2.38	2.38	2.38	---	---	---
40	5.78	5.78	5.78	5.78	---	---	---
30	8.68	8.68	8.68	8.68	8.67	2.98	8.67
20	14.21	15.98	15.98	14.15	28.26	28.26	28.26
10	19.85	30.09	41.45	34.63	39.64	28.26	28.26
TOTAL	114.23	126.24	137.60	128.95	139.91	122.84	128.52

DIVE PROFILE COMPARISON

PROFILE 9 150/30

Stops (FSW)	MVAL5	MVAL83	MVAL92	MVAL97	VVAL09	VVAL14	VVAL18
150	30.00	30.00	30.00	30.00	30.00	30.00	30.00
90	0.58	0.58	0.58	0.58	---	---	---
80	1.52	1.52	1.52	1.52	---	---	---
70	2.94	2.94	2.94	2.94	---	---	---
60	3.56	3.56	3.56	3.56	3.21	---	---
50	3.77	3.77	3.77	3.77	6.94	2.33	2.33
40	7.69	7.69	7.69	7.69	6.94	6.94	6.94
30	8.68	8.68	8.68	8.68	12.29	11.58	11.58
20	14.01	15.78	15.78	13.95	14.37	15.93	21.62
10	19.85	28.22	35.51	32.75	38.80	28.26	28.26
TOTAL	97.59	107.73	115.02	110.43	117.55	100.04	105.73

DIVE PROFILE COMPARISON

PROFILE 10 100/45

Stops (FSW)	MVAL5	MVAL83	MVAL92	MVAL97	VVAL09	VVAL14	VVAL18
100	45.00	45.00	45.00	45.00	45.00	45.00	45.00
50	1.70	1.70	1.70	1.70	---	---	---
40	4.00	4.00	4.00	4.00	---	---	---
30	7.18	7.18	7.18	7.18	---	---	---
20	9.24	8.55	8.55	6.72	12.59	6.90	12.59
10	17.97	17.42	17.42	21.90	28.26	28.26	28.26
TOTAL	88.44	87.20	87.20	89.84	89.18	83.50	89.18

DIVE PROFILE COMPARISON

PROFILE 11 (150/30)*2 ; 10/90

Stops (FSW)	MVAL5	MVAL83	MVAL92	MVAL97	VVAL09	VVAL14	VVAL18
150	30.00	30.00	30.00	30.00	30.00	30.00	30.00
90	0.58	0.58	0.58	0.58	---	---	---
80	1.52	1.52	1.52	1.52	---	---	---
70	2.94	2.94	2.94	2.94	---	---	---
60	3.56	3.56	3.56	3.56	3.21	---	---
50	3.77	3.77	3.77	3.77	6.94	2.33	2.33
40	7.69	7.69	7.69	7.69	6.94	6.94	6.94
30	8.68	8.68	8.68	8.68	12.29	11.58	11.58
20	14.01	15.78	15.78	13.95	14.37	15.93	21.62
10	90.00	90.00	90.00	90.00	90.00	90.00	90.00
150	30.00	30.00	30.00	30.00	30.00	30.00	30.00
90	0.58	0.58	0.58	0.58	---	---	---
80	1.52	1.52	1.52	1.52	---	---	---
70	2.82	2.82	2.82	2.82	---	---	---
60	3.56	3.56	3.56	3.56	2.79	---	---
50	3.77	3.77	3.77	3.77	6.94	1.92	1.91
40	7.22	7.21	7.21	7.22	6.94	6.94	6.94
30	8.68	8.68	8.68	8.68	13.95	18.43	21.45
20	15.56	17.24	44.18	15.50	36.94	28.26	28.26
10	30.69	44.08	76.84	50.53	56.69	43.58	37.21
TOTAL	276.80	293.63	353.32	296.51	327.67	295.58	297.91

DIVE PROFILE COMPARISON

PROFILE 12 75/120

Stops (FSW)	MVAL5	MVAL83	MVAL92	MVAL97	VVAL09	VVAL14	VVAL18
75	120.00	120.00	120.00	120.00	120.00	120.00	120.00
30	6.23	6.23	6.23	6.23	---	---	---
20	16.79	18.56	31.43	16.72	40.61	23.55	28.12
10	28.25	40.17	65.05	44.75	56.69	56.69	52.12
TOTAL	173.75	187.45	225.21	190.20	219.80	202.74	202.74

DIVE PROFILE COMPARISON

PROFILE 20 (60/ND)*3;(0/80)*2

Stops (FSW)	MVAL5	# MVAL83	# MVAL92	# MVAL97	VVAL09	# VVAL14	VVAL18
60	5.63	71.06	65.64	66.64	73.20	83.58	73.20
0	80.00	80.00	80.00	80.00	80.00	80.00	80.00
60	5.63	43.41	44.95	41.30	15.18 (23.88)	22.45 (31.84)	23.18 (34.75)
0	80.00	80.00	80.00	80.00	80.00	80.00	80.00
60	5.63	42.63	34.85	40.22	13.89 (22.69)	16.05 (25.95)	23.18 (30.27)
TOTAL	182.89	323.10	309.44	314.16	268.26 (285.77)	288.08 (307.37)	285.55 (304.22)

#Profile actually tested.

NOTE: Times in parenthesis assume 30% O₂ at 1 ATA (see text).

DIVE PROFILE COMPARISON

PROFILE 21 40/ND ; 0/80 ; 100/ND

Stops (FSW)	MVAL5	MVAL83	MVAL92	# MVAL97	VVAL09	# VVAL14	VVAL18
40	-	234.98	215.62	210.24	244.97	366.54	366.54
0	80.00	80.00	80.00	80.00	80.00	80.00	80.00
100	1.40	16.56	12.63	15.75	4.33 (7.86)	4.38 (7.99)	4.38 (7.99)
TOTAL	-	336.21	312.25	310.69	333.96 (337.49)	455.59 (459.19)	455.59 (459.19)

Profiles actually tested.

NOTE: Times in parenthesis assume 30% O₂ at 1 ATA (see text).

DIVE PROFILE COMPARISON

PROFILE 22 (100/ND)*4 ; (0/80)*3

Stops (FSW)	MVAL5	MVAL83	# MVAL92	# MVAL97	# VVAL09	# VVAL14	VVAL18
100	1.40	18.23	18.23	18.23	19.84	28.47	26.18
0	80.00	80.00	80.00	80.00	80.00	80.00	80.00
100	1.40	18.20	18.20	18.20	10.59 (14.56)	5.78 (9.79)	5.48 (9.36)
0	80.00	80.00	80.00	80.00	80.00	80.00	80.00
100	1.40	18.20	18.20	16.98	5.86 (9.36)	5.78 (9.79)	5.48 (9.36)
0	80.00	80.00	80.00	80.00	80.00	80.00	80.00
100	1.40	16.62	13.63	15.78	5.48 (9.36)	5.78 (9.79)	5.48 (9.36)
TOTAL	258.91	324.58	321.59	322.52	295.11 (306.45)	299.14 (311.17)	295.96 (307.59)

Profiles actually tested.

NOTE: Times in parenthesis assume 30% O₂ at 1 ATA (see text).

DIVE PROFILE COMPARISON

PROFILE 23 (80/ND)*4 ; (0/80)*2 ; (0/60)*1

Stops (FSW)	MVAL5	MVAL83	MVAL92	# MVAL97	# VVAL09	VVAL14	VVAL18
80	2.77	35.66	35.66	35.66	38.65	42.38	38.65
0	80.00	80.00	80.00	80.00	80.00	80.00	80.00
80	2.77	27.82	27.82	25.85	9.46 (15.27)	10.14 (16.26)	9.46 (15.27)
0	80.00	80.00	80.00	80.00	80.00	90.00	80.00
80	2.77	24.26	21.82	23.08	9.46 (14.45)	10.14 (16.26)	9.46 (15.27)
0	60.00	60.00	60.00	60.00	60.00	60.00	60.00
80	2.77	20.02	14.34	19.01	6.25 (9.15)	7.85 (12.51)	7.29 (11.87)
TOTAL	241.74	338.43	330.31	334.27	294.48 (308.15)	301.17 (318.08)	295.52 (311.73)

Profiles actually tested.

NOTE: Times in parenthesis assume 30% O₂ at 1 ATA (see text).

DIVE PROFILE COMPARISON

PROFILE 24 (150/27, 24) ; (0/80)*2 ; 100/ND

Stops (FSW)	MVAL5	MVAL83	MVAL92	MVAL97	VVAL09	VVAL14	VVAL18
150	27.00	27.00	27.00	27.00	27.00	27.00	27.00
90	0.48	0.48	0.48	0.48	---	---	---
80	1.52	1.52	1.52	1.52	---	---	---
70	2.26	2.26	2.26	2.26	---	---	---
60	3.56	3.56	3.56	3.56	0.77	---	---
50	3.77	3.77	3.77	3.77	6.94	---	---
40	6.15	6.15	6.15	6.15	6.94	6.83	6.83
30	8.68	8.68	8.68	8.68	7.91	7.20	7.20
20	11.29	13.06	13.06	11.22	14.05	14.05	16.93
10	19.85	23.74	25.52	28.24	29.27	25.46	28.26
0	80.00	80.00	80.00	80.00	80.00	80.00	80.00
150	24.00	24.00	24.00	24.00	24.00	24.00	24.00
90	0.31	0.31	0.31	0.31	---	---	---
80	1.52	1.52	1.52	1.52	---	---	---
70	1.60	1.60	1.60	1.60	---	---	---
60	3.37	3.37	3.37	3.37	---	---	---
50	3.77	3.77	3.77	3.77	4.79 (4.42)	---	---
40	4.43	4.40	4.38	4.38	9.95 (6.94)	11.02 (6.45)	8.80 (4.24)
30	8.68	8.68	8.68	8.68	17.51 (13.64)	22.30 (19.62)	26.69 (24.00)
20	11.59	13.00	22.85	10.96	30.37 (28.39)	28.26 (28.26)	28.26 (28.26)
10	25.24	36.38	71.26	40.44	56.69 (56.69)	39.58 (37.28)	32.85 (30.27)
0	60.00	60.00	60.00	60.00	60.00	60.00	60.00
100	1.40	13.49	9.47	12.83	3.08 (5.76)	3.37 (6.18)	3.37 (6.18)
TOTAL	323.78	354.03	396.80	358.05	392.58 (386.04)	362.40 (355.66)	363.51 (356.51)

Profiles actually tested.

NOTE: Times in parenthesis assumes 30% O₂ at 1 ATA (See text).

DIVE PROFILE COMPARISON
 PROFILE 24A (150/30)*2 ; 0/80

Stops (FSW)	MVAL5	MVAL83	MVAL92	MVAL97	VVAL09	VVAL14	VVAL18
150	30.00	30.00	30.00	30.00	30.00	30.00	30.00
90	0.58	0.58	0.58	0.58	---	---	---
80	1.52	1.52	1.52	1.52	---	---	---
70	2.94	2.94	2.94	2.94	---	---	---
60	3.56	3.56	3.56	3.56	3.21	---	---
50	3.77	3.77	3.77	3.77	6.94	2.33	2.33
40	7.69	7.69	7.69	7.69	6.94	6.94	6.94
30	8.68	8.68	8.68	8.68	12.29	11.58	11.58
20	14.01	15.78	15.78	13.95	14.37	15.93	21.62
10	19.85	28.22	35.51	32.75	38.80	28.26	28.26
0	80.00	80.00	80.00	80.00	80.00	80.00	80.00
150	30.00	30.00	30.00	30.00	30.00	30.00	30.00
90	0.58	0.58	0.58	0.58	---	---	---
80	1.52	1.52	1.52	1.52	---	---	---
70	2.94	2.94	2.94	2.94	---	---	---
60	3.56	3.56	3.56	3.56	3.21 (3.00)	---	---
50	3.77	3.77	3.77	3.77	6.94 (6.94)	6.44 (2.72)	4.63 (2.13)
40	7.78	7.74	7.72	7.73	13.31 (9.84)	7.55 (14.73)	21.87 (17.83)
30	8.68	8.68	8.68	8.68	25.41 (22.56)	28.26 (28.26)	28.26 (28.26)
20	16.66	17.93	43.93	15.95	41.30 (40.01)	28.26 (28.26)	28.26 (28.26)
10	32.27	45.35	77.44	50.71	56.69 (56.69)	57.13 (51.16)	52.63 (47.10)
TOTAL	290.34	314.79	380.16	320.87	379.40 (371.58)	352.69 (340.17)	356.37 (344.31)

Profiles actually tested.

NOTE: Times in parenthesis assumes 30% O₂ at 1 ATA (See text).

DIVE PROFILE COMPARISON

PROFILE 25A (100/60,57) ; 0/80

Stops (FSW)	MVAL5	MVAL83	MVAL92	MVAL97	VVAL09	VVAL14	# VVAL19
100	60.00	60.00	60.00	60.00	60.00	60.00	60.00
50	2.38	2.38	2.38	2.38	---	---	---
40	5.78	5.78	5.78	5.78	---	---	---
30	8.68	8.68	8.68	8.68	8.67	2.98	8.67
20	14.21	15.98	15.98	14.15	28.26	28.26	28.26
10	19.85	30.09	41.45	34.63	39.64	28.26	28.26
0	80.00	80.00	80.00	80.00	80.00	80.00	80.00
100	50.00	50.00	50.00	50.00	50.00	50.00	50.00
50	2.01	2.01	2.01	2.01	---	---	---
40	4.00	4.00	4.00	4.00	---	---	---
30	8.41	8.38	8.36	8.37	17.96 (13.22)	19.20 (14.45)	22.57 (17.83)
20	12.25	13.43	25.63	11.45	41.42 (38.74)	33.84 (31.16)	28.26 (28.26)
10	27.43	37.66	74.42	42.18	56.69 (56.69)	56.69 (56.69)	56.41 (52.72)
TOTAL	301.67	325.07	385.36	330.30	389.31 (381.89)	365.89 (358.47)	369.10 (360.67)

Profiles actually tested.

NOTE: Times in parenthesis assume 30% O₂ at 1 ATA (see text).

DIVE PROFILE COMPARISON

PROFILE 26 (80/90,85) ; 0/60

Stops (FSW)	MVAL5	MVAL83	MVAL92	MVAL97	VVAL09	VVAL14	VVAL18
80	90.00	90.00	90.00	90.00	90.00	90.00	90.00
40	0.50	0.50	0.50	0.50	---	---	---
30	7.79	7.79	7.79	7.79	---	---	---
20	14.15	15.92	18.43	14.08	25.32	19.64	25.32
10	20.67	32.63	48.44	37.18	52.74	41.37	35.68
0	60.00	60.00	60.00	60.00	60.00	60.00	60.00
80	85.00	85.00	85.00	85.00	85.00	85.00	85.00
40	0.48	0.48	0.48	0.48	---	---	---
30	7.53	7.51	7.49	7.50	7.57 (3.44)	3.46 (1.50)	9.15 (7.19)
20	15.11	16.34	43.81	14.39	56.69 (56.69)	51.78 (49.61)	46.10 (43.93)
10	33.47	48.77	80.25	54.18	56.69 (56.69)	68.44 (67.25)	68.56 (67.39)
TOTAL	340.04	370.26	447.52	376.44	439.34 (435.21)	425.02 (419.71)	425.15 (419.84)

NOTE: Times in parenthesis assume 30% O₂ at 1 ATA (see text)

DIVE PROFILE COMPARISON

PROFILE 27 (120/ND)*4 ; (0/80)*2 ; (0/60)*1

Stops (FSW)	MVAL5	MVAL83	MVAL92	MVAL97	VVAL09	VVAL14	# VVAL18
120	0.49	11.75	11.75	11.75	10.26	17.45	17.45
0	80.00	80.00	80.00	80.00	80.00	80.00	80.00
120	0.49	11.72	11.72	11.72	7.56 (10.23)	6.91 (9.72)	5.26 (8.08)
0	80.00	80.00	80.00	80.00	80.00	60.00	80.00
120	0.49	11.72	11.72	11.72	6.25 (9.34)	3.63 (6.60)	3.45 (6.35)
0	60.00	60.00	60.00	60.00	60.00	60.00	60.00
120	0.49	11.47	11.12	10.44	3.21 (4.99)	2.55 (4.84)	2.40 (4.63)
TOTAL	237.96	282.67	282.32	281.64	263.29 (270.82)	266.54 (274.62)	264.56 (272.51)

Profiles actually tested.

NOTE: Times in parenthesis assume 30% O₂ at 1 ATA (see text)

DIVE PROFILE COMPARISON

PROFILE 28 (140/ND)*3 ; (0/80)*2 ; (0/60)

Stops (FSW)	MVAL5	MVAL63	MVAL92	MVAL97	VVAL09	VVAL14	# VVAL18
140	0.00	7.26	7.26	7.26	6.50	10.67	10.67
10	0.53	---	---	---	---	---	---
0	80.00	80.00	80.00	80.00	80.00	80.00	80.00
140	0.00	7.26	7.26	7.26	4.69 (6.47)	5.96 (8.50)	5.96 (8.39)
10	0.53	---	---	---	---	---	---
0	80.00	80.00	80.00	80.00	80.00	80.00	80.00
140	0.00	7.26	7.26	7.26	4.38 (6.47)	3.65 (5.64)	2.36 (4.44)
10	0.53	---	---	---	---	---	---
0	60.00	60.00	60.00	60.00	60.00	60.00	60.00
140	0.00	7.26	7.26	7.25	2.99 (5.12)	1.41 (3.22)	1.30 (3.07)
10	0.53	---	---	---	---	---	---
TOTAL	240.77	267.71	267.71	267.71	257.22 (263.22)	260.36 (266.68)	258.96 (265.24)

Profile actually tested.

NOTE: Times in parenthesis assume 30% O₂ at 1 ATA (see text).

DIVE PROFILE COMPARISON

PROFILE 29 (150/ND)*4 ; (0/80)*2 ; (0/60)*1

Stops (FSW)	MVAL5	MVAL83	MVAL92	MVAL97	VVAL09	VVAL14	VVAL18
150	0.00	5.96	5.96	5.96	5.34	8.54	8.54
10	1.32	---	---	---	---	---	---
0	80.00	80.00	80.00	80.00	80.00	80.00	80.00
150	0.00	5.96	5.96	5.96	3.71 (5.32)	5.19 (7.39)	5.19 (7.39)
10	1.32	---	---	---	---	---	---
0	80.00	80.00	80.00	80.00	80.00	80.00	80.00
150	0.00	5.96	5.96	5.96	3.70 (5.32)	3.66 (5.51)	2.49 (4.34)
10	1.32	---	---	---	---	---	---
0	60.00	60.00	60.00	60.00	60.00	60.00	60.00
150	0.00	5.96	5.96	5.96	2.29 (4.34)	0.95 (2.59)	0.85 (2.46)
10	1.32	---	---	---	---	---	---
TOTAL	245.29	263.85	263.85	263.85	255.04 (260.33)	258.34 (264.03)	257.08 (262.74)

NOTE: Times in parenthesis assume 30% O₂ at 1 ATA (see text).

DI' PROFILE COMPARISON

PROFILE 30 50/ND; 0.80; 80/ND

Stops (FSW)	MVAL5	MVAL83	MVAL92	MVAL97	VVAL09	VVAL14	VVAL18
50	9.41	109.10	109.10	102.73	111.39	142.22	142.22
0	80.00	80.00	80.00	80.00	80.00	80.00	80.00
80	2.77	24.26	23.30	23.08	7.10 (12.14)	7.77 (13.15)	7.77 (13.15)
TOTAL	96.52	217.70	216.74	210.14	202.83 (207.86)	234.32 (239.70)	234.32 (239.70)

NOTE: Times in parenthesis assume 30% O₂ at 1 ATA (see text).

APPENDIX D

MK 15/16 0.7 ATA PO₂ in N₂

DECOMPRESSION TABLES

Tables in feet with 10 FSW Stop Depth Increment and in meters with 3 MSW
Stop Depth Increments

Tables of different depth grouping are separated by a line of ***. Within each depth grouping is a solid limit line. Profiles above the limit line are the only ones used in planning a dive. Profiles below the limit line are for emergency use only. Each profile is backed up by profiles down to 20 FSW (or 6 MSW) deeper and up to 20 minutes longer.

RULES

Table D-1 outlines the rules for using the following decompression tables. These rules will allow some degree of repetitive diving until a formal repetitive diving procedure can be formulated. In rule 2-C, note that the actual depth is used to get the residual nitrogen time rather than an equivalent air depth. For dives below 77 FSW, this will result in a longer residual nitrogen time since the equivalent air depth will be deeper (with a shorter residual nitrogen time) than the actual depth. For dives shallower than 77 FSW, this extra margin of safety is not necessary so the fact that equivalent air depth will be shallower is of little significance.

In rule 3, actual depth is used to find the maximum depth. It was not felt necessary to use equivalent air depth because this would make the rule more complicated and the fact that no surface interval credit is given will add the necessary degree of safety.

TABLE D-1

RULES FOR USING

0.7 ATA CONSTANT PO₂ IN NITROGEN

DECOMPRESSION TABLES

1. These tables are designed to be used with a MK 15 or MK 16 UBA with a set point of 0.7 ATA or greater and a nitrogen or N₂O₂ diluent.

2. When selecting the proper decompression tables, all dives done within the past 12 hours must be considered. The following rules apply for the various situations which may occur:

a. The last dive was 12 hours or more ago.

Select the table for the maximum depth attained and the total bottom time of the current dive.

b. All dives within the past 12 hours were from these tables.

Add the bottom time of the current dive to the sum of the bottom times for all dives within the past 12 hours to get the adjusted bottom time. Use the maximum depth attained within the past 12 hours and the adjusted bottom time to select the appropriate table.

c. All dives during the past 12 hours were from the Navy Standard Air Tables.

Add the standard air residual nitrogen time for the actual depth of the current dive to the total time of the current dive to get the adjusted total bottom time. Use the maximum depth of the current dive and the adjusted total bottom time to select the appropriate table.

d. Dives within the past 12 hours consisted of dives from more than one of the various tables in the Diving Manual or from tables other than these or the standard air tables.

Use the procedure in paragraph b. above.

3. If an air dive is planned following using these tables, an air repetitive group for use with future air dives may be computed as follows:

Add the bottom times of all dives done within 12 hours of surfacing from the final dive from these tables to get an adjusted bottom time. Find the air table with the maximum depth attained during the past 12 hours and the adjusted bottom time. The repetitive group from this air table may be used to compute the repetitive group at the end of the surface interval for subsequent air dives.

**MK 15/16 0.7 ATA PO₂
in Na Decompression Tables**

**Depth in Feet of Sea Water (FSW)
Stops in 10 FSW Increments**

**Solid line in each set of tables
is the Limit Lines**

TABLE OF MAXIMUM PERMISSIBLE TISSUE TENSIONS

(VVAL10- NITROGEN)

TISSUE HALF-TIMES

DEPTH	5 MIN	10 MIN	20 MIN	40 MIN	60 MIN	120 MIN	160 MIN	200 MIN	240 MIN
	1.00 SDR	1.00 SDR	1.00 SDR	1.00 SDR	1.00 SDR	1.00 SDR	1.00 SDR	1.00 SDR	1.00 SDR
10 FSU	120.000	90.000	70.000	56.000	48.500	45.500	44.500	44.000	43.500
20 FSU	130.000	100.000	80.000	66.000	58.500	55.500	54.500	54.000	53.500
30 FSU	140.000	110.000	90.000	76.000	68.500	65.500	64.500	64.000	63.500
40 FSU	150.000	120.000	100.000	86.000	78.500	75.500	74.500	74.000	73.500
50 FSU	160.000	130.000	110.000	96.000	88.500	85.500	84.500	84.000	83.500
60 FSU	170.000	140.000	120.000	106.000	98.500	95.500	94.500	94.000	93.500
70 FSU	180.000	150.000	130.000	116.000	108.500	105.500	104.500	104.000	103.500
80 FSU	190.000	160.000	140.000	126.000	118.500	115.500	114.500	114.000	113.500
90 FSU	200.000	170.000	150.000	136.000	128.500	125.500	124.500	124.000	123.500
100 FSU	210.000	180.000	160.000	146.000	138.500	135.500	134.500	134.000	133.500
110 FSU	220.000	190.000	170.000	156.000	148.500	145.500	144.500	144.000	143.500
120 FSU	230.000	200.000	180.000	166.000	158.500	155.500	154.500	154.000	153.500
130 FSU	240.000	210.000	190.000	176.000	168.500	165.500	164.500	164.000	163.500
140 FSU	250.000	220.000	200.000	186.000	178.500	175.500	174.500	174.000	173.500
150 FSU	260.000	230.000	210.000	196.000	188.500	185.500	184.500	184.000	183.500
160 FSU	270.000	240.000	220.000	206.000	198.500	195.500	194.500	194.000	193.500
170 FSU	280.000	250.000	230.000	216.000	208.500	205.500	204.500	204.000	203.500
180 FSU	290.000	260.000	240.000	226.000	218.500	215.500	214.500	214.000	213.500
190 FSU	300.000	270.000	250.000	236.000	228.500	225.500	224.500	224.000	223.500
200 FSU	310.000	280.000	260.000	246.000	238.500	235.500	234.500	234.000	233.500
210 FSU	320.000	290.000	270.000	256.000	248.500	245.500	244.500	244.000	243.500
220 FSU	330.000	300.000	280.000	266.000	258.500	255.500	254.500	254.000	253.500
230 FSU	340.000	310.000	290.000	276.000	268.500	265.500	264.500	264.000	263.500
240 FSU	350.000	320.000	300.000	286.000	278.500	275.500	274.500	274.000	273.500
250 FSU	360.000	330.000	310.000	296.000	288.500	285.500	284.500	284.000	283.500
260 FSU	370.000	340.000	320.000	306.000	298.500	295.500	294.500	294.000	293.500
270 FSU	380.000	350.000	330.000	316.000	308.500	305.500	304.500	304.000	303.500
280 FSU	390.000	360.000	340.000	326.000	318.500	315.500	314.500	314.000	313.500
290 FSU	400.000	370.000	350.000	336.000	328.500	325.500	324.500	324.000	323.500
300 FSU	410.000	380.000	360.000	346.000	338.500	335.500	334.500	334.000	333.500

BLOOD PARAMETERS

(PRESSURE IN FSU; 33 FSU=1 ATA)

PACO2	PN2O	PVCC2	PVO2	ANBAO2	PBOVP
1.50	0.00	2.30	2.00	6.00	0.000

2:43 PM MON., 13 FEB., 1984 TBLP7 VYAL18 (FEET)

.70 ATA FIXED PO2 IN NITROGEN

DESCENT RATE 60 FPM

ASCENT RATE 60 FPM

DEPTH (FSW)	BTM TIM	TM FIRST (M)	TO STOP	DECOMPRESSION STOPS (FSW)											TOT ASC TIM (M)			
				150	140	130	120	110	100	90	80	70	60	50		40	30	20
40	365	0:40															0	0:
40	370	0:30															1	1:
40	380	0:30															2	2:
40	390	0:30															3	3:

50	143	0:50															0	0:
50	150	0:40															4	4:
50	160	0:40															8	8:
50	170	0:40															12	12:
50	180	0:40															16	16:
50	190	0:40															19	19:
50	200	0:40															22	22:
50	210	0:40															25	25:
50	220	0:40															29	29:
50	230	0:40															33	33:
50	240	0:40															38	38:
50	250	0:40															42	42:
50	260	0:40															46	46:
50	270	0:40															49	49:
50	280	0:40															53	53:
50	290	0:40															56	56:
50	300	0:40															59	59:
50	310	0:40															62	62:
50	320	0:40															64	64:
50	330	0:40															67	67:
50	340	0:40															70	70:

2:43 PM MON., 13 FEB., 1984 TBLP7 VVAL18 (FEET)

.70 ATA FIXED PO2 IN NITROGEN

DESCENT RATE 60 FPM

ASCENT RATE 60 FPM

DEPTH (FSW)	BTM (M)	TM TO FIRST STOP	DECOMPRESSION STOPS (FSW)													TOTAL ASCNT TIME (M:S)		
			150	140	130	120	110	100	90	80	70	60	50	40	30		20	10
50	350	0:40															73	73:50
50	360	0:40															77	77:50
50	370	0:40															80	80:50
50	380	0:40															84	84:50
50	390	0:40															87	87:50

60	74	1:00															0	1:00
60	80	0:50															4	5:00
60	90	0:50															9	10:00
60	100	0:50															13	14:00
60	110	0:50															17	18:00
60	120	0:50															25	26:00
60	130	0:50															32	33:00
60	140	0:50															39	40:00
60	150	0:50															45	46:00
60	160	0:50															50	51:00
60	170	0:50															56	57:00
60	180	0:40														4	59	64:00
60	190	0:40														8	62	71:00
60	200	0:40														12	65	78:00
60	210	0:40														16	68	85:00
60	220	0:40														19	71	91:00
60	230	0:40														22	74	97:00
60	240	0:40														25	76	102:00
60	250	0:40														28	79	108:00
60	260	0:40														30	82	113:00

2:43 PM MON., 13 FEB., 1984 TBLP7 YVAL18 (FEET)

.70 ATA FIXED PO2 IN NITROGEN DESCENT RATE 60 FPM ASCENT RATE 60 FPM

DEPTH (FSW)	BTM (M)	TM TO FIRST STOP	DECOMPRESSION STOPS (FSW) STOP TIMES (MIN)													TOTAL ASCNT TIME (M:S)				
			150	140	130	120	110	100	90	80	70	60	50	40	30		20	10		
60	270	0:40															32	85	118:00	
60	280	0:40															36	87	124:00	
60	290	0:40															40	89	130:00	
60	300	0:40															44	92	137:00	
60	310	0:40															47	94	142:00	
60	320	0:40															51	96	148:00	
60	330	0:40															54	98	153:00	
60	340	0:40															57	100	158:00	
60	350	0:40															60	102	163:00	
60	360	0:40															63	105	169:00	
60	370	0:40															66	108	175:00	
60	380	0:40															68	111	180:00	
60	390	0:40															71	114	186:00	

70	51	1:10															0	1:10		
70	60	1:00															9	10:10		
70	70	1:00															18	19:10		
70	80	1:00															25	26:10		
70	90	0:50															3	28	32:10	
70	100	0:50															8	33	42:10	
70	110	0:50															12	39	52:10	
70	120	0:50															16	45	62:10	
70	130	0:50															19	51	71:10	
70	140	0:50															22	56	79:10	
70	150	0:50															29	58	88:10	
70	160	0:50															36	62	99:10	

2:43 PM MON., 13 FEB., 1984 TBLP7 VVAL18 (FEET)

.70 ATA FIXED PO2 IN NITROGEN DESCENT RATE 60 FPM ASCENT RATE 60 FPM

DEPTH (FSW)	BTM (M)	TM TO FIRST STOP	DECOMPRESSION STOPS (FSW) STOP TIMES (MIN)														TOTAL ASCENT TIME (M: S)		
			150	140	130	120	110	100	90	80	70	60	50	40	30	20		10	
70	170	0:50															43	65	109:10
70	180	0:50															48	70	119:10
70	190	0:40												1	53	73	128:10		
70	200	0:40											2	57	76	136:10			
70	210	0:40											6	57	80	144:10			
70	220	0:40											11	56	84	152:10			
70	230	0:40											14	59	86	160:10			
70	240	0:40											18	62	89	170:10			
70	250	0:40											21	65	92	179:10			
70	260	0:40											24	69	93	187:10			
70	270	0:40											27	71	97	196:10			
70	280	0:40											29	75	99	204:10			
70	290	0:40											31	78	102	212:10			
70	300	0:40											33	81	105	220:10			
70	310	0:40											35	83	110	229:10			
70	320	0:40											37	86	113	237:10			
70	330	0:40											42	85	118	246:10			
70	340	0:40											45	86	124	256:10			
70	350	0:40											49	88	127	265:10			

80	39	1:20														0	1:20		
80	40	1:10														1	2:20		
80	50	1:10														15	16:20		
80	60	1:10														27	28:20		
80	70	1:00														9	38:20		
80	80	1:00														18	47:20		

2:43 PM MON., 13 FEB., 1984 TBLP7 VVAL18 (FEET)

.70 ATA FIXED PO2 IN NITROGEN

DESCENT RATE 60 FPM

ASCENT RATE 60 FPM

DEPTH (FSW)	BTM (M)	TM TO FIRST STOP	DECOMPRESSION STOPS (FSW)													TOTAL ASCNT TIME (M:S)					
			150	140	130	120	110	100	90	80	70	60	50	40	30		20	10			
80	90	1:00															25	34	60:20		
80	100	0:50															3	28	42	74:20	
80	110	0:50															8	28	50	87:20	
80	120	0:50															12	29	57	99:20	
80	130	0:50															16	36	57	110:20	
80	140	0:50															19	42	62	124:20	
80	150	0:50															21	49	66	137:20	
80	160	0:50															24	55	70	150:20	
80	170	0:50															29	57	75	162:20	
80	180	0:50															36	57	79	173:20	
80	190	0:50															43	56	84	184:20	
80	200	0:40															1	47	60	86	195:20
80	210	0:40															2	52	64	89	208:20
80	220	0:40															3	56	68	92	220:20
80	230	0:40															7	56	73	96	233:20
80	240	0:40															11	56	77	99	244:20
80	250	0:40															14	57	80	104	256:20
80	260	0:40															18	57	84	109	269:20
80	270	0:40															21	59	85	116	282:20
80	280	0:40															24	63	85	123	296:20
80	290	0:40															27	66	85	130	309:20
80	300	0:40															29	70	88	133	321:20
80	310	0:40															31	73	91	137	333:20
80	320	0:40															33	76	94	141	345:20

90	32	1:30															0			1:30	

2:43 PM MON., 13 FEB., 1984 TBLP7 VVAL18 (FEET)

.70 ATA FIXED PO2 IN NITROGEN

DESCENT RATE 60 FPM

ASCENT RATE 60 FPM

DEPTH (FSW)	BTM (M)	TM FIRST STOP	DECOMPRESSION STOPS (FSW) STOP TIMES (MIN)													TOTAL ASCNT TIME (M:S)					
			150	140	130	120	110	100	90	80	70	60	50	40	30		20	10			
90	40	1:20															14	15:30			
90	50	1:10															3	28	32:30		
90	60	1:10															17	28	46:30		
90	70	1:00															1	28	28	58:30	
<hr/>																					
90	80	1:00															10	29	34	74:30	
90	90	1:00															19	28	43	91:30	
90	100	1:00															26	28	52	107:30	
90	110	0:50															4	28	32	57	122:30
90	120	0:50															9	28	40	62	140:30
90	130	0:50															13	28	49	66	157:30
90	140	0:50															16	29	56	72	174:30
90	150	0:50															19	36	56	76	188:30
90	160	0:50															22	42	57	81	203:30
90	170	0:50															24	49	57	88	219:30
90	180	0:50															26	55	61	91	234:30
90	190	0:50															32	56	67	94	250:30

100	27	1:40															0			1:40	
100	30	1:30															6			7:40	
100	35	1:30															17			18:40	
100	40	1:30															28			29:40	
100	45	1:20															10	28		39:40	
100	50	1:20															19	28		48:40	
100	55	1:20															27	29		57:40	
100	60	1:10															7	28	28	64:40	
100	65	1:10															14	28	28	71:40	

2:43 PM MON., 13 FEB., 1984 TBLP7 VVAL18 (FEET)

.70 ATA FIXED PO2 IN NITROGEN DESCENT RATE 60 FPM ASCENT RATE 60 FPM

DEPTH (FSW)	BTM (M)	TM TO FIRST STOP	DECOMPRESSION STOPS (FSW)													TOTAL ASCNT TIME (M:S)				
			150	140	130	120	110	100	90	80	70	60	50	40	30		20	10		
100	70	1:10												20	28	31	80:40			
100	75	1:10												26	28	36	91:40			
100	80	1:00											3	28	29	41	102:40			
100	90	1:00											13	28	28	52	122:40			
100	100	1:00											21	28	33	61	144:40			
100	110	1:00											27	29	43	65	165:40			

110	24	1:50															0	1:50		
110	25	1:40															3	4:50		
110	30	1:40															17	18:50		
110	35	1:30															2	28	31:50	
110	40	1:30															14	28	43:50	
110	45	1:30															25	28	54:50	

110	50	1:20												7	28	28	64:50			
110	55	1:20												16	28	29	74:50			
110	60	1:20												25	28	28	82:50			
110	65	1:10											4	29	28	32	94:50			
110	70	1:10											12	28	28	38	107:50			
110	80	1:10											24	28	29	50	132:50			
110	90	1:00											7	28	28	33	65	162:50		

120	19	2:00															0	2:00		
120	20	1:50															1	3:00		
120	25	1:50															12	14:00		
120	30	1:40															4	24	30:00	
120	35	1:40															14	29	45:00	
120	40	1:30															5	23	28	58:00

2:43 PM MON., 13 FEB., 1984 TBLP7 VVAL18 (FEET)

.70 ATA FIXED PO2 IN NITROGEN DESCENT RATE 60 FPM ASCENT RATE 60 FPM

DEPTH (FSW)	BTM (M)	TM TO FIRST STOP	DECOMPRESSION STOPS (FSW)														TOTAL ASCNT TIME (M:S)			
			150	140	130	120	110	100	90	80	70	60	50	40	30	20		10		
120	45	1:30													12	28	28	70:00		
120	50	1:20													2	21	28	81:00		
120	55	1:20													6	27	29	92:00		
120	60	1:20													14	29	28	105:00		
120	70	1:10													3	28	28	138:00		
120	80	1:10													17	28	28	173:00		

130	16	2:10															0	2:10		
130	20	2:00															6	8:10		
130	25	1:50															5	17	24:10	
130	30	1:40															3	9	41:10	
130	35	1:40															7	20	57:10	
130	40	1:30															1	14	72:10	
130	45	1:30															7	20	85:10	
130	50	1:30															13	26	98:10	
130	60	1:20															7	26	133:10	
130	70	1:20															23	28	175:10	

140	13	2:20																0	2:20	
140	15	2:10																2	4:20	
140	20	2:00																4	7	13:20
140	25	1:50																4	7	34:20
140	30	1:40																2	7	52:20
140	35	1:40																5	12	70:20
140	40	1:30																1	10	86:20
140	45	1:30																4	14	100:20
140	50	1:30																10	17	119:20

2:43 PM MON., 13 FEB., 1984 TBLP7 YVAL18 (FEET)

.70 ATA FIXED P02 IN NITROGEN DESCENT RATE 60 FPM ASCENT RATE 60 FPM

DEPTH (FSW)	BTM (M)	TM TO FIRST STOP	DECOMPRESSION STOPS (FSW)											TOTAL ASCNT TIME (M:S)			
			150	140	130	120	110	100	90	80	70	60	50		40	30	20
140	60	1:20									6	16	29	28	28	59	168:20
140	70	1:20									14	28	28	29	34	79	214:20

150	11	2:30														0	2:30
150	15	2:10													2	4	8:30
150	20	2:00												2	7	10	21:30
150	25	1:50											3	6	8	24	43:30
150	30	1:40									1	7	8	17	29	64:30	

150	35	1:40									4	8	14	26	28	82:30	
150	40	1:40									7	15	19	28	28	99:30	
150	45	1:30								2	13	14	28	28	34	121:30	
150	50	1:30								8	14	21	28	28	48	149:30	
150	60	1:20							4	14	22	28	29	30	75	204:30	
150	70	1:20							11	22	29	28	28	50	91	261:30	

160	9	2:40														0	2:40
160	10	2:30														1	3:40
160	15	2:10												1	4	5	12:40
160	20	2:00											1	6	7	13	29:40
160	25	1:50										1	7	7	10	26	53:40
160	30	1:50										7	7	10	20	29	75:40
160	40	1:40								7	11	14	23	28	35	120:40	
160	50	1:30								5	14	14	26	28	29	63	181:40

170	8	2:50														0	2:50
170	10	2:40														3	5:50
170	15	2:10											1	3	3	7	16:50
170	20	2:00										1	4	7	7	17	38:50

2:43 PM MON., 13 FEB., 1984 TBLP7 VVAL18 (FEET)

.70 ATA FIXED P02 IN NITROGEN DESCENT RATE 60 FPM ASCENT RATE 60 FPM

DEPTH (FSW)	BTM (M)	TM TO FIRST STOP	DECOMPRESSION STOPS (FSW) STOP TIMES (MIN)													TOTAL ASCNT TIME (M:SS)		
170	25	2:00	150	140	130	120	110	100	90	80	70	60	50	40	30	20	10	63:50
170	30	1:50									6	7	7	13	24	26	87:50	
170	40	1:40								6	8	14	14	27	28	44	143:50	
170	50	1:30							3	13	14	17	28	28	35	75	215:50	

MK 15/16 0.7 ATA PO₂
in Na Decompression Tables

Depth in Meters of Sea Water (MSW)
Stops in 3 MSW Increments

Solid line in each set of Tables
is the Limit Line

TABLE OF MAXIMUM PERMISSIBLE TISSUE TENSIONS

(WVALIF - NITROGEN)

TISSUE HALF-TIMES

DEPTH	5 MIN	10 MIN	20 MIN	40 MIN	60 MIN	120 MIN	160 MIN	200 MIN	240 MIN
	1.00 SDR	1.00 SDR	1.00 SDR	1.00 SDR	1.00 SDR	1.00 SDR	1.00 SDR	1.00 SDR	1.00 SDR
3 MSW	120.000	98.000	78.000	56.000	48.500	45.500	44.500	44.000	43.500
6 MSW	129.843	107.843	87.843	65.843	58.343	55.343	54.343	53.843	53.343
9 MSW	139.685	117.685	97.685	75.685	68.185	65.185	64.185	63.685	63.185
12 MSW	149.528	127.528	107.528	85.528	78.028	75.028	74.028	73.528	73.028
15 MSW	159.370	137.370	117.370	95.370	87.870	84.870	83.870	83.370	82.870
18 MSW	169.213	147.213	127.213	105.213	97.713	94.713	93.713	93.213	92.713
21 MSW	179.055	157.055	137.055	115.055	107.555	104.555	103.555	103.055	102.555
24 MSW	188.898	166.898	146.898	124.898	117.398	114.398	113.398	112.898	112.398
27 MSW	198.740	176.740	156.740	134.740	127.240	124.240	123.240	122.740	122.240
30 MSW	208.583	186.583	166.583	144.583	137.083	134.083	133.083	132.583	132.083
33 MSW	218.425	196.425	176.425	154.425	146.925	143.925	142.925	142.425	141.925
36 MSW	228.268	206.268	186.268	164.268	156.768	153.768	152.768	152.268	151.768
39 MSW	238.110	216.110	196.110	174.110	166.610	163.610	162.610	162.110	161.610
42 MSW	247.953	225.953	205.953	183.953	176.453	173.453	172.453	171.953	171.453
45 MSW	257.795	235.795	215.795	193.795	186.295	183.295	182.295	181.795	181.295
48 MSW	267.638	245.638	225.638	203.638	196.138	193.138	192.138	191.638	191.138
51 MSW	277.480	255.480	235.480	213.480	205.980	202.980	201.980	201.480	200.980
54 MSW	287.323	265.323	245.323	223.323	215.823	212.823	211.823	211.323	210.823
57 MSW	297.166	275.166	255.166	233.166	225.665	222.665	221.665	221.165	220.665
60 MSW	307.008	285.008	265.008	243.008	235.508	232.508	231.508	231.008	230.508
63 MSW	316.851	294.851	274.851	252.851	245.351	242.351	241.351	240.851	240.351
66 MSW	326.693	304.693	284.693	262.693	255.193	252.193	251.193	250.693	250.193
69 MSW	336.536	314.536	294.536	272.536	265.036	262.036	261.036	260.536	260.036
72 MSW	346.378	324.378	304.378	282.378	274.878	271.878	270.878	270.378	269.878
75 MSW	356.221	334.221	314.221	292.221	284.721	281.721	280.721	280.221	279.721
78 MSW	366.063	344.063	324.063	302.063	294.563	291.563	290.563	290.063	289.563
81 MSW	375.906	353.906	333.906	311.906	304.406	301.406	300.406	299.906	299.406
84 MSW	385.748	363.748	343.748	321.748	314.248	311.248	310.248	309.748	309.248
87 MSW	395.591	373.591	353.591	331.591	324.091	321.091	320.091	319.591	319.091
90 MSW	405.433	383.433	363.433	341.433	333.933	330.933	329.933	329.433	328.933

BLOOD PARAMETERS

(PRESSURE IN FSU; 33 FSU=1 ATA)

PACO2	PH2O	PVCO2	PVO2	AMBAO2	PBOVP
1.50	0.80	2.30	2.00	0.00	0.000

4:15 PM MON., 13 FEB., 1984 TBLP7 YVAL18 (METERS)

100 ATA FIXED PO2 IN NITROGEN

DESCENT RATE 18 MPM

ASCENT RATE 18 MPM

DEPTH (MSW)	BTM TIM	TM FIRST (M)	TO STOP (M:S)	DECOMPRESSION STOPS (MSW) STOP TIMES (MIN)												TOTAL ASCNT TIME (M:S)		
				45	42	39	36	33	30	27	24	21	18	15	12		9	6
12	390	0:40															0	0:40

15	149	0:50															0	0:50
15	150	0:40															1	1:50
15	160	0:40															5	5:50
15	170	0:40															9	9:50
15	180	0:40															12	12:50
15	190	0:40															15	15:50
15	200	0:40															18	18:50
15	210	0:40															21	21:50
15	220	0:40															24	24:50
15	230	0:40															28	28:50
15	240	0:40															33	33:50
15	250	0:40															37	37:50
15	260	0:40															40	40:50
15	270	0:40															44	44:50
15	280	0:40															47	47:50
15	290	0:40															50	50:50
15	300	0:40															53	53:50
15	310	0:40															56	56:50
15	320	0:40															59	59:50
15	330	0:40															61	61:50
15	340	0:40															64	64:50
15	350	0:40															66	66:50
15	360	0:40															70	70:50
15	370	0:40															73	73:50

4:15 PM MON., 13 FEB., 1984 TBLP7 VVAL18 (METERS)

.70 ATA FIXED PO2 IN NITROGEN DESCENT RATE 18 MPM ASCENT RATE 18 MPM

DEPTH (MSW)	BTH (M)	TM (M)	TO FIRST STOP	DECOMPRESSION STOPS (MSW) STOP TIMES (MIN)												TOTAL ASCNT TIME (M:S)				
			(M:S)	45	42	39	36	33	30	27	24	21	18	15	12	9	6	3		
15	380	0:40																	77	77:50
15	390	0:40																	80	80:50

18	77	1:00																	0	1:00
18	80	0:50																	2	3:00
18	90	0:50																	7	8:00
18	100	0:50																	11	12:00
18	110	0:50																	14	15:00
18	120	0:50																	21	22:00
18	130	0:50																	28	29:00
18	140	0:50																	35	36:00
18	150	0:50																	41	42:00
18	160	0:50																	46	47:00
18	170	0:50																	51	52:00
18	180	0:50																	58	59:00
18	190	0:40															5	60	66:00	
18	200	0:40															9	63	73:00	
18	210	0:40															12	66	79:00	
18	220	0:40															15	69	85:00	
18	230	0:40															18	72	91:00	
18	240	0:40															21	74	96:00	
18	250	0:40															24	77	102:00	
18	260	0:40															26	79	106:00	
18	270	0:40															28	82	111:00	
18	280	0:40															31	85	117:00	
18	290	0:40															35	87	123:00	

4:15 PM MON., 13 FEB., 1984 TBLP7 YVAL18 (METERS)

.70 ATA FIXED PO2 IN NITROGEN DESCENT RATE 18 MPM ASCENT RATE 18 MPM

DEPTH (MSW)	BTM (M)	TM TO FIRST STOP (M:S)	DECOMPRESSION STOPS (MSW) STOP TIMES (MIN)													TOTAL ASCNT TIME (M:S)			
			45	42	39	36	33	30	27	24	21	18	15	12	9		6	3	
18	300	0:40															38	90	129:00
18	310	0:40															42	91	134:00
18	320	0:40															46	93	140:00
18	330	0:40															49	95	145:00
18	340	0:40															52	97	150:00
18	350	0:40															55	99	155:00
18	360	0:40															57	101	159:00
18	370	0:40															60	104	165:00
18	380	0:40															62	108	171:00
18	390	0:40															65	110	176:00

21	53	1:10															0		1:10
21	60	1:00															7		8:10
21	70	1:00															15		16:10
21	80	1:00															22		23:10
21	90	0:50															1	27	29:10
21	100	0:50															6	31	38:10
21	110	0:50															10	37	48:10
21	120	0:50															13	44	58:10
21	130	0:50															16	50	67:10
21	140	0:50															19	55	75:10
21	150	0:50															26	55	82:10
21	160	0:50															32	60	93:10
21	170	0:50															39	63	103:10
21	180	0:50															44	68	113:10
21	190	0:50															50	70	121:10

4:15 PM MON., 13 FEB., 1984 T8LP7 YVAL18 (METERS)

.70 ATA FIXED PO2 IN NITROGEN

DESCENT RATE 18 MPM

ASCENT RATE 18 MPM

DEPTH (MSW)	BTM (M)	TM TO FIRST STOP (M: S)	DECOMPRESSION STOPS (MSW) STOP TIMES (MIN)											TOTAL ASCNT TIME (M: S)			
			45	42	39	36	33	30	27	24	21	18	15		12	9	6
21	200	0:50													54	75	130:10
21	210	0:40													3	56	78:10
21	220	0:40													7	56	81:10
21	230	0:40													11	57	83:10
21	240	0:40													14	60	86:10
21	250	0:40													17	64	88:10
21	260	0:40													20	67	91:10
21	270	0:40													23	69	94:10
21	280	0:40													25	73	96:10
21	290	0:40													27	76	99:10
21	300	0:40													29	78	102:10
21	310	0:40													31	81	105:10
21	320	0:40													33	83	110:10
21	330	0:40													36	84	114:10
21	340	0:40													40	84	119:10
21	350	0:40													44	85	122:10

24	41	1:20														0	1:20
24	50	1:10														13	14:20
24	60	1:10														25	26:20
24	70	1:00														7	28:36:20
24	80	1:00														15	28:44:20
24	90	1:00														22	34:57:20

24	100	0:50														1	27:41:70:20
24	110	0:50														6	27:49:83:20
24	120	0:50														10	28:55:94:20

4:15 PM MON., 13 FEB., 1984 TBLP7 VVAL18 (METERS)

.70 ATA FIXED PO2 IN NITROGEN

DESCENT RATE 18 MPM

ASCENT RATE 18 MPM

DEPTH (MSW)	BTM (M)	TM TO FIRST STOP (M: S)	DECOMPRESSION STOPS (MSW) STOP TIMES (MIN)												TOTAL ASCENT TIME (M: S)		
			45	42	39	36	33	30	27	24	21	18	15	12		9	6
24	130	0:50												13	35	55	104:20
24	140	0:50												16	41	60	118:20
24	150	0:50												19	47	64	131:20
24	160	0:50												21	53	68	143:20
24	170	0:50												26	55	73	155:20
24	180	0:50												32	56	78	167:20
24	190	0:50												39	55	82	177:20
24	200	0:50												44	58	84	187:20
24	210	0:50												50	62	86	199:20
24	220	0:40											1	53	67	89	211:20
24	230	0:40											3	56	70	93	223:20
24	240	0:40											7	56	74	97	235:20
24	250	0:40											11	56	78	99	245:20
24	260	0:40											14	56	82	104	257:20
24	270	0:40											17	58	83	110	269:20
24	280	0:40											20	61	84	116	282:20
24	290	0:40											23	64	84	123	295:20
24	300	0:40											25	67	86	128	307:20
24	310	0:40											27	71	88	132	319:20
24	320	0:40											29	74	91	136	331:20

27	33	1:30														0	1:30
27	40	1:20														12	13:30
27	50	1:10													1	28	30:30
27	60	1:10													15	28	44:30
27	70	1:10													26	28	55:30

4:15 PM MON., 13 FEB., 1984 TBLP7 YVAL18 (METERS)

.70 ATA FIXED PO2 IN NITROGEN

DESCENT RATE 18 MPM

ASCENT RATE 18 MPM

DEPTH (MSW)	BTM (M)	TM TO FIRST STOP (M: S)	DECOMPRESSION STOPS (MSW) STOP TIMES (MIN)											TOTAL ASCNT TIME (M: S)				
			45	42	39	36	33	30	27	24	21	18	15		12	9	6	3
27	80	1:00												8	28	33	70:30	
27	90	1:00												17	27	42	87:30	
27	100	1:00												23	28	50	102:30	
27	110	0:50											1	28	31	56	117:30	
27	120	0:50											6	28	39	59	133:30	
27	130	0:50											10	28	47	64	150:30	
27	140	0:50											14	28	54	70	167:30	
27	150	0:50											17	34	55	74	181:30	
27	160	0:50											19	41	56	78	195:30	
27	170	0:50											21	48	55	85	210:30	
27	180	0:50											23	53	60	88	225:30	
27	190	0:50											28	56	64	91	240:30	

30	28	1:40														0	1:40	
30	30	1:30														4	5:40	
30	35	1:30														15	16:40	
30	40	1:30														26	27:40	
30	45	1:20													8	28	37:40	
30	50	1:20													17	28	46:40	
30	55	1:20													25	28	54:40	
30	60	1:10												5	27	28	61:40	
30	65	1:10												12	27	28	68:40	
30	70	1:10												18	28	29	76:40	
30	75	1:10												24	27	35	87:40	
30	80	1:00												1	28	28	39	97:40
30	90	1:00												11	27	28	50	117:40

4:15 PM MON., 13 FEB., 1984 TBLP7 VVAL18 (METERS)

.70 ATA FIXED PO2 IN NITROGEN DESCENT RATE 18 MPH ASCENT RATE 18 MPH

DEPTH (MSW)	BTM (M)	TM FIRST STOP (M: S)	DECOMPRESSION STOPS (MSW) STOP TIMES (MIN)													TOTAL ASCNT TIME (M: S)			
			45	42	39	36	33	30	27	24	21	18	15	12	9		6	3	
30	100	1:00												18	28	32	58	137:40	
30	110	1:00												25	28	41	63	158:40	

33	24	1:50															0	1:50	
33	25	1:40															1	2:50	
33	30	1:40															15	16:50	
33	35	1:30														1	27	29:50	
33	40	1:30															12	28	41:50
33	45	1:30															23	28	52:50

33	50	1:20													5	28	28	62:50	
33	55	1:20														14	28	28	71:50
33	60	1:20														22	28	28	79:50
33	65	1:10												2	28	28	30	89:50	
33	70	1:10												9	28	28	36	102:50	
33	80	1:10												22	28	27	48	126:50	
33	90	1:00												5	27	28	31	62	154:50

36	20	2:00															0	2:00	
36	25	1:50															10	12:00	
36	30	1:40															3	23	28:00
36	35	1:40															12	28	42:00
36	40	1:30														3	23	27	55:00

36	45	1:30														10	28	27	67:00
36	50	1:30														21	28	27	78:00
36	55	1:20												4	27	28	28	89:00	
36	60	1:20												12	28	28	31	101:00	
36	70	1:10												1	28	28	27	44	130:00

4:15 PM MON., 13 FEB., 1984 TBLP7 VVAL18 (METERS)

.70 ATA FIXED PO2 IN NITROGEN DESCENT RATE 18 MPM ASCENT RATE 18 MPM

DEPTH (MSW)	BTM (M)	TM TO FIRST STOP (M:S)	DECOMPRESSION STOPS (MSW) STOP TIMES (MIN)											TOTAL ASCNT TIME (M:S)							
			45	42	39	36	33	30	27	24	21	18	15		12	9	6	3			
36	80	1:10										15	28	27	29	65	166:00				

39	17	2:10														0	2:10				
39	20	2:00														5	7:10				
39	25	1:50													4	16	22:10				
39	30	1:40												2	8	27	39:10				
39	35	1:40												6	19	28	55:10				
39	40	1:40												13	26	28	69:10				

39	45	1:30												6	19	27	28	82:10			
39	50	1:30												11	26	27	28	94:10			
39	60	1:20												6	24	28	28	38	126:10		
39	70	1:20												20	28	28	28	61	167:10		

42	13	2:20														0	2:20				
42	15	2:10														2	4:20				
42	20	2:00														3	7	12:20			
42	25	1:50													3	7	19	31:20			
42	30	1:40													1	7	12	28	50:20		

42	35	1:40													4	11	22	28	67:20		
42	40	1:40													10	15	28	28	83:20		
42	45	1:30													3	14	22	28	28	97:20	
42	50	1:30													9	16	27	28	32	114:20	
42	60	1:20													4	16	28	28	27	54	159:20
42	70	1:20													12	28	27	28	53	75	205:20

45	11	2:30														0	2:30				
45	15	2:10														1	4	7:30			
45	20	2:00														1	7	9	19:30		

4:15 PM MON., 13 FEB., 1984 TBLP7 VVAL18 (METERS)

170 ATA FIXED PO2 IN NITROGEN DESCENT RATE 18 MPH ASCENT RATE 18 MPH

DEPTH (MSW)	BTM (M)	TM FIRST STOP (M: S)	DECOMPRESSION STOPS (MSW) STOP TIMES (MIN)											TOTAL ASCNT TIME (M: S)						
			45	42	39	36	33	30	27	24	21	18	15		12	9	6	3		
45	25	1:50												1	7	7	24	41:30		
45	30	1:50												7	7	17	28	61:30		
45	35	1:40										3	8	14	24	28	79:30			
45	40	1:40										6	14	19	27	28	96:30			
45	45	1:30									1	12	14	27	28	31	115:30			
45	50	1:30									6	14	20	28	28	42	140:30			
45	60	1:20								2	14	22	28	27	28	72	195:30			
45	70	1:20								9	22	28	28	27	46	87	249:30			

46	10	2:33															0	2:33		
46	15	2:13														2	4	8:33		
46	20	2:03													3	7	10	22:33		
46	25	1:53												3	7	8	24	44:33		
46	30	1:43										2	7	8	18	28	65:33			
46	35	1:43										5	9	14	26	27	83:33			
46	40	1:33									1	8	14	20	28	28	101:33			
46	45	1:33									3	14	14	28	28	34	123:33			
46	50	1:33									10	14	22	28	27	48	151:33			
46	60	1:23									6	14	24	27	28	32	74	207:33		
46	70	1:23									13	24	28	28	28	51	90	264:33		

48	10	2:40															0	2:40		
48	15	2:10														1	3	5	11:40	
48	20	2:00														1	5	7	12	27:40
48	25	2:00														7	7	9	25	50:40
48	30	1:50												6	6	11	19	28	72:40	
48	40	1:40												5	11	14	22	28	31	113:40

4:15 PM MON., 13 FEB., 1984 TBLP7 YVAL18 (METERS)

.70 ATA FIXED PO2 IN NITROGEN DESCENT RATE 18 MPM ASCENT RATE 18 MPM

DEPTH (MSW)	BTM (M)	TM FIRST STOP (M:S)	DECOMPRESSION STOPS (MSW) STOP TIMES (MIN)											TOTAL ASCNT TIME (M:S)													
			45	42	39	36	33	30	27	24	21	18	15		12	9	6	3									
48	50	1:30															3	14	14	25	28	28	58	172:40			

51	8	2:50																					0	2:50			
51	10	2:40																					3	5:50			
51	15	2:20																			3	4	6	15:50			
51	20	2:00																	1	3	7	7	15	35:50			
51	25	2:00																	5	7	7	12	27	60:50			
51	30	1:50																	5	6	7	13	23	84:50			
51	40	1:40																	5	7	14	14	26	27	41	136:50	
51	50	1:30																	2	13	13	16	28	28	32	71	205:50
