

# INNOVATIVE NEW ROV TECHNOLOGY UTILISING WATER HYDRAULICS

Gry Karin HAUGEN<sup>♦</sup> Finn CONRAD<sup>♦</sup> Mads GRAHL-MADSEN<sup>♦</sup>

<sup>♦</sup>Department of Mechanical and Marine Engineering, Bergen University College, Bergen, Norway  
gry.haugen@hib.no mgm@hib.no

<sup>♦</sup>Department of Mechanical Engineering, Technical University of Denmark  
Building 404, Kgs. Lyngby, Denmark  
E-mail: finn.conrad@mek.dtu.dk

## ABSTRACT

Today, Remotely Operated Vehicles, or ROV's, are the dominating type of vehicles for underwater operations and very much the working horse of the North Sea, and both the military and the scientific sectors are increasing their use of ROVs. An ROV is normally designed for underwater work using oil hydraulics or electricity for propulsion and tool control. ROV's using the surrounding water itself as the energy carrier for propulsion and tool control has never been successfully developed. The paper presents research results on a new ROV with water hydraulic propulsion system is being developed at Bergen University College. The design of the propulsion system is based on components available on the market. The ROV will have two thrusters for manoeuvring in the horizontal plane, and one thruster for vertical positioning. Static calculations and dynamic simulations have been performed to investigate the performance of the water hydraulic propulsion system. The simulations have been performed applying VisSim. The flow control valve has been tested to investigate the capability of flow regulation at low flow rates. Furthermore, this paper presents the selected experimental results and performance results.

## KEY WORDS

Remotely Operated Vehicles ROV, Water Hydraulics

## INTRODUCTION

The unmanned underwater vehicle industry, including both remotely operated vehicles (ROVs) and autonomous underwater vehicles (AUVs) is about 30 years old. A typical example of ROV for research in Norway is shown in Figures 1. During this period, these unmanned vehicles have evolved from unreliable prototypes developed for research and military use into essential everyday tools. Without ROVs many ocean industries such as deepwater oil and gas production would not exist. Applications range from simple 'remote eyeball' observation tasks to high precision seabed surveys and manipulative tasks such as pipeline connection and servicing of sub-sea oil and gas production installation. In March 1995 a designed and

tested Japanese ROV reached the deepest sea-water depth point of the Mariana Trench at 10,911 m (Hawley, Nuckols et al. 1996), [1].

Today, ROV's are the dominating type of vehicles for underwater operations and very much the working horse of the North Sea. The design of an ROV is normally based on oil hydraulics or electricity for propulsion and tool control. ROV's using the surrounding water itself as the energy carrier for propulsion and tool control has never been successfully developed.

Water hydraulics in its modern form has been available and in several industrial applications for more than 10 years, (Conrad, Hilbrecht and Jepsen, 2000), [2].

However, in relation to underwater technology not much work has been carried out. Even that oil hydraulics and water hydraulics are both fluid medium

water has other properties than hydraulic oils, Conrad, 2000, [2], (Backé,1999, [3]) and (Seabrook and Burrows, 1994), [4].

An ROV with water hydraulic propulsion system is being developed. The ROV is neutrally buoyant, has two thrusters for manoeuvring in the horizontal plane, and one thruster for positioning vertically, light and camera. Mathematical modelling and dynamic simulations using VisSim are undertaken for investigation of the performance of the water hydraulic propulsion system. The flow control valve was tested for the capability of flow control at low flow rates. Experimental results are presented and discussed.

## REMOTELY OPERATED VEHICLES – ROV

The name a ROV (Remotely Operated Vehicle) is an underwater vehicle connected to the surface by an umbilical, which transfer electrical power, information and control signals to and from the surface work platform. Real-time communication between the surface and the vehicle allows for the operation and manoeuvring of the ROV as shown in Figure 1. The ROV system normally consists of the vehicle itself, an umbilical connected to the surface, a winch for handling of the vehicle and umbilical cable, a power distribution unit (PDU) and a control unit, see Figure 1.

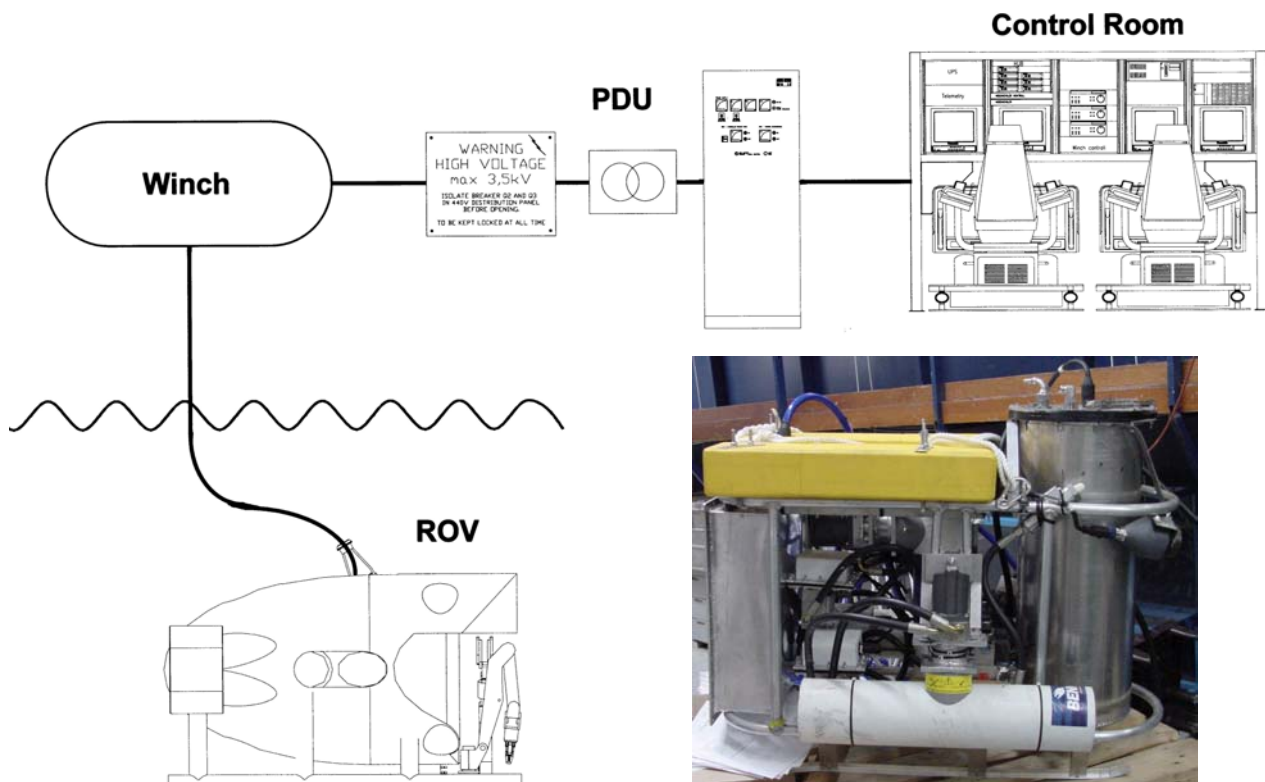

Figure 1. Underwater ROV System

<i>Observation</i>	<i>Survey</i>	<i>Inspection</i>	<i>Manipulative Tasks</i>
Visual observation with camera	Seabed observation, often together with acoustic mapping	Inspection of fixed structures, pipelines, cables and subsea systems	Requires manipulators and/or additional tools. Typical tasks are: installation and replacement of modules, valve operation, connecting subsea equipment during field development, pipeline tie-in etc.

Table 1

The ROV system normally consists of the vehicle itself, an umbilical connected to the surface, a winch for handling of the vehicle and umbilical cable, a power distribution unit (PDU) and a control unit, Figure 1. The main ROV tasks are described as in Table 1.

Cameras and light provide vision for the ROV pilot and other sensors like compass, pressure sensors and transponder provide additional information. A work class ROV is normally equipped with two hydraulically operated manipulator arms to perform various tasks.

The ROV can also be equipped with specialized tools to perform various tasks such as valve operation, sand blasting, wire cutting etc. The tasks for an ROV can be divided into active and passive. The passive tasks do not require manipulators or torque tools, such as observation, survey and inspection. Active tasks are defined as manipulative tasks.

### NOVEL R&D ROV IN BERGEN

A novel ROV with a water hydraulic propulsion system as shown in Figure 2, and with light and camera is being developed at Bergen University College. Danfoss Nessie Water hydraulic components are used for the ROV propulsion system, and Sleipner Motor supplies the thrusters. Two thrusters operate the propulsion and turning of the ROV in the horizontal plane, and one

thruster to position the vehicle vertically. The ROV system consists of a control centre with joysticks for operation of the thrusters and to adjust focus of the camera. The ultimate goal, in respect of research is to develop a fully operational water hydraulic operated ROV and introduce new technology to the business. The project three main activities are

1. Water hydraulic propulsion and control systems
2. Hydrodynamic design and optimization
3. Instrumentation and navigation

Initial tests of the propulsion system have been carried out, revealing limitations with respect to speed control of the water hydraulic motors.

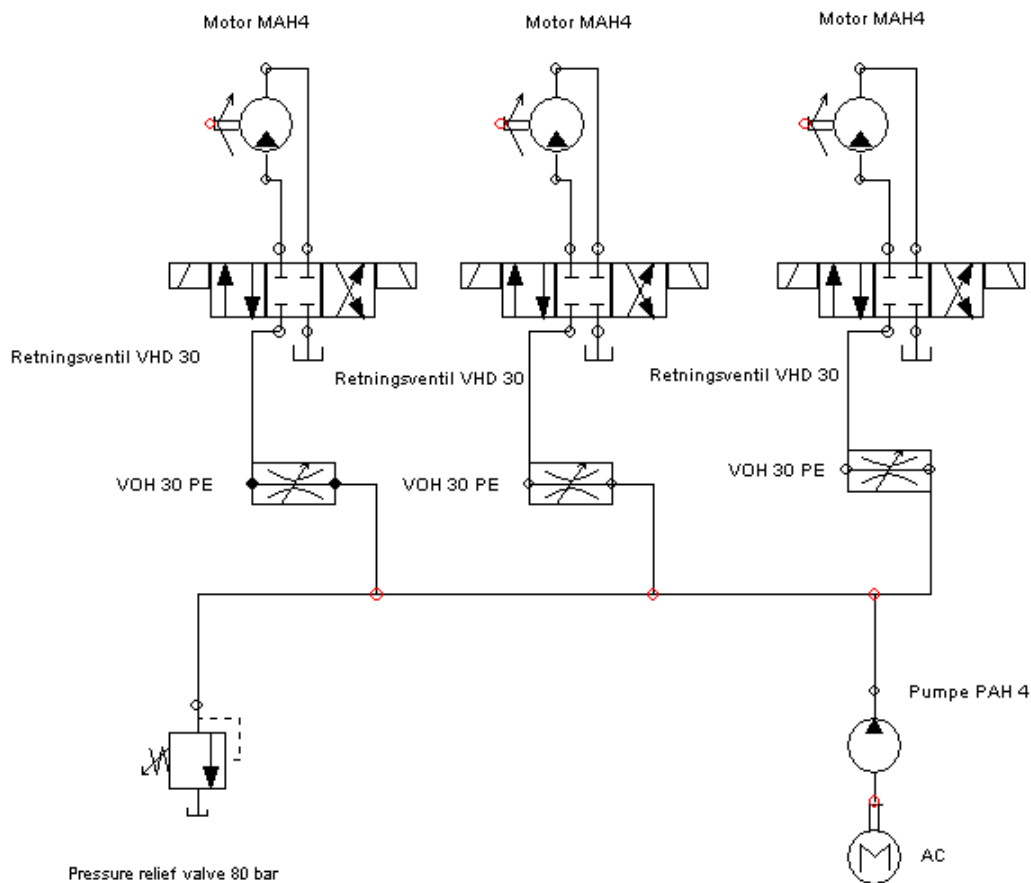

Figure 2. Hydraulic circuit of the novel ROV propulsion system

Only one motor could be running at a time, with little adjustment of the speed. An attempt to run two motors simultaneously failed, causing the first motor to stop as well. This could indicate a problem with the flow regulation, or a problem with the motors. Calculations to investigate the expected performance of the hydraulic system have therefore been performed.

One water hydraulic axial piston pump, Nessie PAH4 has  $4 \text{ cm}^3/\text{rev}$  is driving the power supply system. The three water hydraulic axial piston motors, Nessie MAH4 have  $4 \text{ cm}^3/\text{rev}$  do drive and control the three tunnel thrusters with a diameter of 125 mm via a gearbox. The applied 4/3 valve controls the rotational direction of the thrusters, and speed via the flow proportional control

valves, VOH 30. A 1.3 kW AC motor drives the water hydraulic pump, and a pressure relief valve at 80 bars prevents pressure build-up in the system.

### MODELLING OF WATER HYDRAULIC PROPULATION SYSTEM

The volume of displaced water is expressed as by [5]

$$V = D_m \theta \quad (1)$$

where  $D_m$  is the displacement/radian and  $\theta$  is total angular rotation for the motor. Hence, the flow rate is

$$Q = \frac{d}{dt}(D_m \theta) = D_m \omega \quad (2)$$

$$P = Q \cdot \Delta p \quad (3)$$

where  $\Delta p$  is the differential pressure over the motor.

The power is

$$P = T_m \omega \quad (4)$$

where  $T_m$  is the motor torque, and  $\omega_m$  is the angular velocity. For an ideal motor with no friction, the mechanical power on the shaft is equal to the hydraulic power of the motor. Combining equation (3) and (4) an expression for the torque on the shaft is obtained

$$T_m = \frac{Q}{\omega} \cdot \Delta p = D_m \Delta p \quad (5)$$

The variation of density with pressure and temperature is

$$d\rho = \frac{\partial \rho}{\partial p} dp + \frac{\partial \rho}{\partial T} dT \quad (6)$$

Assuming isothermal conditions, the isothermal bulk modulus

$$\beta = \rho \frac{\partial p}{\partial \rho} \quad (7)$$

Equation (6) and (7) combines to

$$\dot{\rho} = \frac{\rho}{\beta} \dot{p} \quad (8)$$

The mass balance for a volume can be written

$$\frac{d}{dt}(\rho V) = w_{in} - w_{out} \quad (9)$$

where  $w_{in}$  and  $w_{out}$  is mass flow in and out of the volume  $V$  respectively. The product rule for derivation gives

$$\dot{\rho} = \frac{\rho}{\beta} \dot{p} \quad (8)$$

The mass balance for a volume can be written

$$\frac{d}{dt}(\rho V) = w_{in} - w_{out} \quad (9)$$

where  $w_{in}$  and  $w_{out}$  is mass flow in and out of the volume  $V$  respectively. The product rule for derivation gives

$$\dot{\rho} V + \rho \dot{V} = \rho(q_{in} - q_{out}) \quad (10)$$

where  $q_{in}$  and  $q_{out}$  are volume flow in and out of the volume. Equations (8) and (10) gives the mass balance

$$\frac{V}{\beta} \dot{p} + \dot{V} = q_{in} - q_{out} \quad (11)$$

Assuming an ideal motor, no internal or external leakage, and constant displacement volume gives

$$\frac{V}{\beta} \dot{p} = q_1 - q_2 \quad (12)$$

where  $q_1$  is flow to the motor, and  $q_2$  is flow from the motor. The flow from the motor gives

$$q_2 = \frac{D_m}{2\pi} \omega \quad (13)$$

Applying the Newton's Second law gives

$$T_m - T_L - T_f = J_m \dot{\omega} \quad (14)$$

where  $T_m$  is the motor torque,  $T_L$  is the external torque on the shaft from the thrusters,  $T_f = B\omega$  is the viscous friction, and  $J_m = I_m$  is the total mass moment of inertia of the motor

$$D_m \cdot (p_1 - p_2) - T_L - B\omega = I_m \dot{\omega} \quad (15)$$

Solved for the initial pressure  $p_{i1}$ , equation (15)

$$p_{i1} = \frac{D_m p_{i2} + T_L + T_s}{D_m} \quad (16)$$

Applying equations (16), (12) and (15) gives

$$\Delta p = \frac{1}{s} \frac{(q_1 - q_2) \beta}{V} \quad (17)$$

$$D_m \cdot (p_1 - p_2) - T_L - B\omega = J_m s^2 \theta_L \quad (18)$$

where angular velocity is  $\omega = s\theta$ .

### EXPERIMENTAL RESULTS

The flow from the pump, and hence the angular velocity of each motor shaft and propeller is controlled with three electrically operated proportional flow control valves, Nessie VOH 30PE. The reaction time from closed to fully open is <150 ms, as shown in Figure 3.

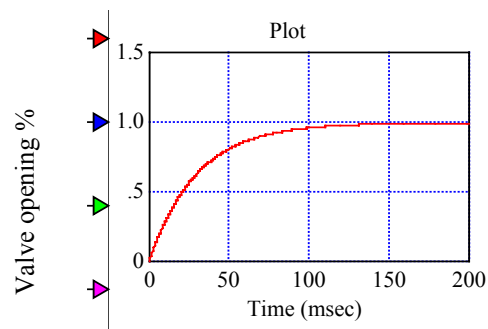

Figure 3 Opening time for proportional valve

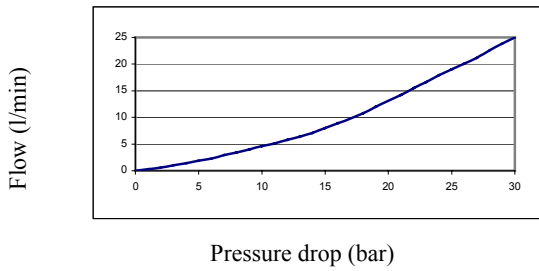

Figure 4 Flow characteristics for 4/3 directional valve

The rotational direction of each motor is controlled by three Nesses VDH 30 EC 4/3 directional valves. The measured flow characteristics of the directional valve are shown in Figure 4. The pressure drop for the 4/3 valve has been added to each curve at the corresponding flow for the proportional control valve. The flow versus rotational speed is shown in Figure 5 for motors.

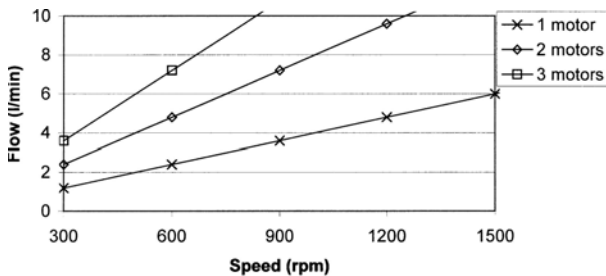

Figure 5 Flow and speed of the water hydraulic motor

The motors can be run from 300 to 4000 rpm. However, with the current used pump gives maximum available flow 5 l/min. The pressure drops versus torque are shown in Figure 6, up to the maximum torque at 8 kN.

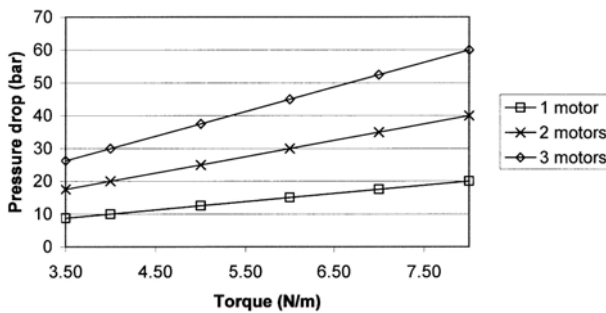

Figure 6 Pressure drop/torque of water hydraulic motor

The required flow versus rotational speed is shown in Figure 5 for motors running from 300 to 4000 rpm. However, with the current pump deliver 4 cm<sup>3</sup>/rev gives maximum available flow 5 l/min. The pressure drops versus torque for the motors are shown in Figure 6.

### SIMULATION RESULTS

The hydraulic motor is modelled in VisSim based on equations describing the relationship between the supply

and return side pressures and flows, torques and angular velocity of the motor.

Two different scenarios have been simulated

1. One motor at minimum speed
2. One motor running with maximum available flow

#### One motor running at minimum speed

The motor is running around 300 rpm. The velocity, pressures and flows on the supply and return side are shown in Figures 7 to 11. The motor speed increases gradually to the steady state value at 310 rpm as shown in Figure 7. The pressure p1 at the supply side and the pressure p2 on the return side is shown in Figure 8. The flow q1 on supply and flow q2 return side of motor are shown in Figure 9. The limit of pressure p1 is approximately 23 Bar, while the pressure p2 reach at almost 2 Bar.

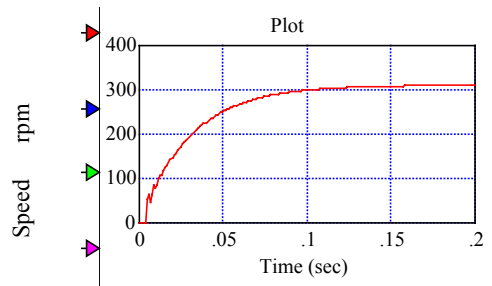

Figure 7 Rotational speed of motor

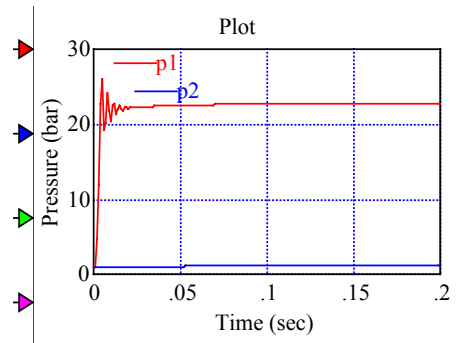

Figure 8 Pressure on supply and return side of motor

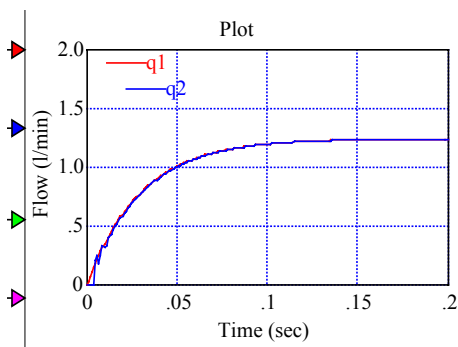

Figure 9 Flow on supply and return side of motor

The pressures will increase with increasing depth of the sea-water; these calculations are valid close to the surface. For a minimum speed of the motor, the flow through the motor stabilises at approximately 1.25 l/min. This shows that a regulation of the flow to around approximately 1.2 l/min after 0.1 second. Upwards is important to provide speed control of the motors to drive and control the thrusters.

**One motor running speed with maximum flow**

A simulation has been performed to establish the motor performance with a maximum flow from the pump of 5 l/min. As seen from Figure 10, one motor can be running at approximately 1250 rpm. This agrees well with the steady state values estimations shown in the previous paragraph on minimum flow rate.

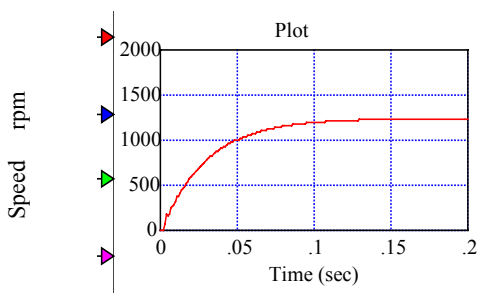

Figure 10 Rotational speed of motor

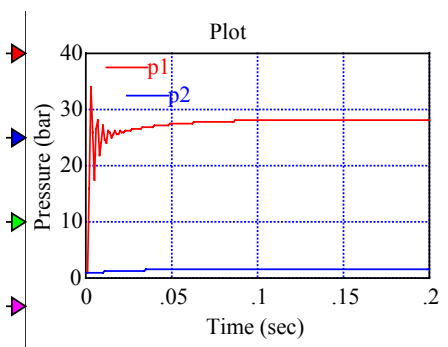

Figure 11 Pressure on supply and return side of motor

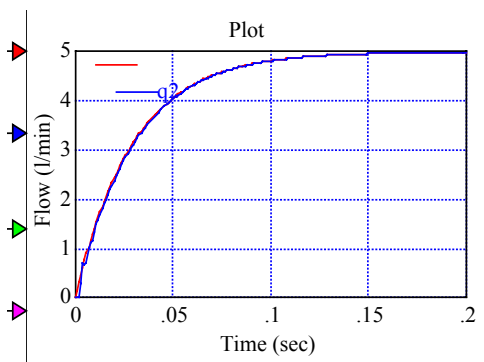

Figure 12 Flow on supply and return side of motor

Figures 11 and 12 show pressure p1 and pressure p2, flow q1 and flow q2. The limit of pressure p1 is

approximately 28 Bar, which is a little higher than the pressure at 300 rpm. This is due to the friction loss. The limit of the flow q1 through the motor is at around 5 l/min, which is the maximum flow from the pump.

**CONCLUSION AND OUTLOOK**

An novel ROV with water hydraulic propulsion system is being developed, designed and implemented at Bergen University College. The ROV has two thrusters for manoeuvring in the horizontal plane, and one thruster for positioning vertically, and equipped with light and camera. Initial tests of the propulsion system have been carried out, revealing limitations with respect to speed control of the water hydraulic motors. Only one motor could be running at a time, with adjustment of the speed. An attempt to run two motors simultaneously failed, causing the first motor to stop as well. This could indicate a problem with the flow regulation, or a problem with the motors. Modelling and dynamic simulations results to evaluate the performance of the water hydraulic propulsion system were presented. The results show that with a pump delivers flow at 4 cm<sup>3</sup>/rev, the system can be running in two different configurations

- One hydraulic motor with a velocity up to 1200 rpm and maximum torque (8 kN) on the motor shaft. This requires a power of about 0.9 kW as the minimum system pressure is 80 bar.
- Two hydraulic motors with a velocity up to 600 rpm and maximum torque (8 kN) on each motor shaft. This requires a power of about 0.9 kW.

Test results indicate that accurate flow regulation in the range of 0 – 5 l/min is as expected difficult to obtain. The used current flow control valve is oversized for the ROV system. There is a need for an available flow control valve for a smaller flow rate on the market to feet accurate regulation of the thrusters. Another flow control valve with better performance for the motor and thrusters speed control is needed for redesign, and to reduce the maximum flow through the valve. New system tests will be performed in the research project

**References**

[1] Hawley, J. G., M. L. Nuckols, et al. *Design Aspects of Underwater Intervention Systems*, Kendall/Hunt Publishing Company, 1996.  
 [2] Conrad, Finn, Bjarne Hilbrecht and Hardy Jepsen. *Design of Low-Pressure and High-Pressure Tap Water Hydraulic Systems for Various Industrial Applications*, Proceedings SAE Paper Number F7-A 2000-01-2614, Society of Automation Engineers Inc., USA 2000.  
 [3] Backé, W. *Water- or oil-hydraulics in the future*, 1999.  
 [4] Seabrook, C. and C. R. Burrows. *Water hydraulics - some design challenges*, ASME, USA, 1994.  
 [5] Watton, John. *Fluid Power Systems*, Prentice Hall, USA, 1989.