

Analysis of integrated sensor for unmanned underwater vehicle application

Mohd Shahrieel Mohd Aras*, Muhammad Nizam Kamarudin, Iktisyam Zainal, Mohd Khairi Mohd Zambri & Marizan Sulaiman

Underwater Technology Research Group (UTeRG), Center for Robotics and Industrial Automation (CERIA), Faculty of Electrical Engineering, Universiti Teknikal Malaysia Melaka, Hang Tuah Jaya, 76100 Durian Tunggal, Melaka, Malaysia

*[E-mail: shahrieel@utem.edu.my]

Received 17 July 2017 ; revised 29 October 2017

This paper presents an integrated sensor system to be applied in underwater vehicles based on 5-DOF Inertial Measurement Unit (IMU) sensor, MPX pressure sensor, and temperature sensor. The main idea of the research is to improve the performance of the integrated sensor system by using the MATLAB/Simulink interfaced with MicroBox 2000/2000C for underwater vehicle applications. An integrated sensor or known as the smart sensor is a small component that designed to gather important data based on underwater applications. These types of sensors combined and integrated with signal processing hardware in a single compact waterproof device. All sensors are placed in a hard casing made of steel with the dimensions of 0.10 m diameter, 0.85 m height and weight of 0.23 kg. The output of the sensors shows that; the offset error of accelerometer and gyroscopes are within 0.5 to 1.0 and 0.1 to 0.5, respectively. It is shown that the pressure occurs at 0.75s and the reading on voltage increased rapidly until 0.5V and maintained at 0.5V for 1 s. With minimum implementation cost and improved performances of the integrated sensors, this research benefits offshore and underwater industries especially for underwater vehicle.

[Keywords: Inertial measurement unit; temperature sensor; pressure sensor; MicroBox 2000/2000C]

Introduction

In underwater industries, the most crucial issues are the sensors that needed for underwater task¹⁻³. The sensors that are utilized are quite expensive. Most of the sensors are not waterproof and there are numbers of obstacles underwater for a sensor to detect an object or to obtain an accurate measurement. Meanwhile, the waterproof sensor has a small number of production as compared to the normal sensor based on very small demands⁴. Thus, the integrated sensor is introduced to facilitate underwater operations such as; searching

objects submerged in the sea or underwater search and rescue procedures⁵⁻⁷.

An integrated sensor or known as a smart sensor is a small component that designed to gather important data. The integrated sensor system based on 5-DOF Inertial Measurement Unit sensor, MPX pressure sensor, and DS temperature sensor. These types of sensors integrate with signal processing hardware in one compact device. It allows the sensor to send signals to be used immediately without additional processing or amplification. An integrated sensor can

reduce the space and weight in order to put other components⁸⁻¹². Within the past few decades, there are a number of sensors that use underwater technology to explore the depths of the ocean, measure and help in the rescue operation and maintaining the safety of soldiers and sailors. With the growing technology, integrated sensor, underwater vehicles (UVs) shows progress in the ordinary military mission to map and detect or determine whether the seabed has mines. It is also can be used to detect an unidentified object.

The main idea is to improve the performance of integrated sensors by reducing the estimation of error, lower in cost, small space and improving the accuracy of range measurements. An integrated sensor is designed based on three goal performances; accuracies, sensitivities, and efficiencies. Thus, the goal of this project is to design and develop the ability of each type of sensor in single circuit and then apply to underwater vehicles by gathering all data by using MicroBox 2000/2000C. An integrated sensors probably contains multiple transduction principles for some functions and it can compare the sensor performance. The integrated sensor is high durability, waterproof, long lasting but incurs a high cost. Moreover, underwater technology in Malaysia is still lagging as compared to underwater technology from other countries such as the United State of America (USA), Russia, Germany, Japan and others. For instance, Malaysia Airline MH370 tragedy demanded technologies from other countries.

As such, this project is developed to overcome the problems that occur in conventional underwater vehicles. Moreover, this project uses three major sensors; 5-DOF Inertial Measurement Unit sensor, MPX pressure sensor and DS temperature sensor that capable of controlling the movement of underwater vehicles¹³. This project benefits the marine or sailors. All three major sensors will be designed as integrated sensors and input controller. All sensors were connected with an Ethernet cable (data cable) with $\pm 0.5\text{m}$ length so that the output values can be more accurate and the delay time can be reduced. The hardware was tested by using MicroBox 2000/2000C as a microcontroller and integrated with Simulink Real-Time MATLAB software design¹⁴⁻¹⁷. The simulation of the control system is conducted to monitor underwater vehicles performances.

The accurate measurement for 5-DOF IMU full-scale range acceleration is $\pm 3\text{g}$ and $\pm 10,000\text{g}$ and for shock survival based on 3-axis position; X-axis, Y-axis, and Z-axis. For rotation with X-/Y-Out pins with $\pm 500^\circ/\text{s}$ full-scale range and $2.0\text{mV}/^\circ/\text{s}$ sensitivity while X/Y 4.5 Out pins with $\pm 110^\circ/\text{s}$ full-scale range and $9.1\text{mV}/^\circ/\text{s}$ sensitivity based on X-axis and Y-axis position. Pressure sensor and temperature sensor tested in different depth until achieved the maximum pressure; 700kPa and the maximum range of depth is about $\pm 70\text{m}$. For the maximum range of temperature about -55°C until 125°C , where the sensor goes down to the deepest of the seabed, the temperature becomes lower because of the influence of light. The hardware was tested in Control and Industrial Automation (CIA) laboratory, only because MicroBox 2000/2000C already set up and integrated with Simulink Real-Time MATLAB 2009 software design to show the performance of the integrated sensors in the output graph for IMU and depth sensor and display digital values for temperature sensor¹⁵⁻¹⁷.

This paper is organized as follows. In section 1, the introduction of the integrated sensors is mentioned. Furthermore, Section 2 presents the literature review of the project while Section 3 describes the methodology of the project. Last but not least, Section 4 and Section 5 illustrate the field testing results and analysis of the results. Finally, the final remarks are elucidated in Section 6.

Literature Review

The integrated sensor mostly contributions for military mission and humanitarian needs. These developments of sensor technologies to improve the better future of sensor to be highly miniaturized and operate using information technology and communication systems^{18, 19, 20}. A number of uses the integrated sensor was limited because the sensors that are utilized for every task are quite costly contributed by high durability, waterproof, long lasting and other factors requirements. The first integrated sensor developed in the early 1940s with Variable Time or known as VT fuze and evolved into innovative sensor systems to apply in underwater, biochemical and space instruments. In early 1980s, the small transducer and sensor systems used to detect acoustic, temperature, barometer and pressure for collecting information on the birds' environment as well as their behavior¹⁹⁻²⁰. Nowadays, there are several sensors and sensor systems with their major strengths; space-based sensors in magnetometers, UV or visible images and

charged particle sensors, submarine acoustic arrays, radar systems for guided missile detection, radar and the chemical and biological sensors. The fully integrated sensor systems where an ensemble of sensors is used to observe large areas and increasing important in communications systems, GPS technologies and microelectromechanical systems or known as MEMS. In addition, the sensor mostly applies in airborne collection platforms, satellites, ships, and underwater fields²¹.

Inertial Measurement Unit (IMU) sensor is an electronic device that used to measure and control the angular velocity and linear acceleration using a combination of IDG500 gyroscopes and ADXL335 accelerometers^{10,12}. The ADXL335 accelerometer generates three analog signal of accelerations to measure the static acceleration of gravity in tilt-sensing application as well as dynamic acceleration resulting from motion, shock or vibration. The IDG500 gyroscope generates three analog signals of angular rate to make vehicles do rotation movements. This small IMU size is widely used in the precision instrumentation, platform stabilization and control, industrial vehicle navigation, robotics and etc. Pressure sensor act as a transducer that generates a signal as a function of pressure. It used to know the depth of operating points. The changes in depth or weight of the water will influence the pressure of the system as defined in Equation (1);

$$\Delta p = -w\Delta h \quad (1)$$

Where:

p is pressure.

w is the weight of the fluid.

h is the depth

The pressure sensor utilized in this project is Manifold Absolute Pressure (MAP) sensor, MPX5700 series used for engine control. The MAP sensor is designed to sense absolute air pressure within the intake manifold of the engine⁹. However, it also can be used to measure a depth of the underwater⁹. Temperature sensor used to measure the temperature readings either the water in heat or cold condition in certain range to provide safety use of the application happen. The temperature sensor utilized in this project is DS18B20 that contains a unique silicon to placing temperature sensors in many different places¹¹.

The temperature sensor can apply in HVAC

environmental controls and process monitoring and control. DS18B20 is a digital thermometer that provides 9 to 12-bit temperature readings to indicate the temperature of the device. The work's principal of DS18B20 is when the information was sent to/from the DS18B20 over a 1-Wire interface, so that only one wire and ground (GND) needs to connect from a central microprocessor to a sensor. DS18B20 contains a unique silicon serial number and to allow for placing temperature sensors in many different places. Microbox 2000/2000C is used to integrate with MATLAB or Simulink Real-Time and related control modules. It can be run real-time modelling and simulation of control systems, rapid prototyping, and hardware in the loop testing¹⁴. Microbox 2000/2000C also acts as a microcontroller and is known as a XPC target machine. For engineers that have real-time analysis and control system testing needs, Microbox 2000/2000C offers an excellent mix of performance, compactness, sturdiness, and I/O expandability. The result benefits to users in terms of cost and time saving and makes the control system design also the testing easy to accomplish. Besides that, it allowed the flexibility when dealing with complex control systems¹⁶.

Methodology

The development of the integrated sensor for the underwater application starts with a project plan. This project is divided into two parts, which are hardware and software. Hardware part consists of three main sensors, which are the MPX5700 pressure sensor, IMU sensor and DS18B20 temperature sensor. All of the sensors are combined as an integrated sensor. Figure 1 shows the process flowchart of this project. Figure 2 shows the integrated sensors. MATLAB Simulink is used as a software design for this project. The design involved with all sensors to identify either the sensors is analogue or digital output. The IMU sensor has five-output signal in analogue input. The pressure sensor has one output signal in analogue input. The temperature sensor has one output signal in digital input. The pin connection of output signal connected to the hardware by interfacing with MicroBox 2000/2000C. Table 1 shows the parameter connection of the integrated sensors to MicroBox.

The connection of the integrated sensor consists of an accelerometer, gyro, pressure sensor and temperature sensor. The pin connections of the integrated sensor are similar to the design for each part in MATLAB Simulink. Figure 3(a) shows the input

and output of MicroBox pin connections. Figure 3(b) shows the pin connection of the integrated sensor to MicroBox.

Table 1 - The parameter connection to Microbox	
Sources of Circuit	Vcc: Connector 3 pin 17 Gnd: Connector 1 pin 19
IMU Sensor (Analog Input)	Accelerometer: Connector 2 pin 1,3,5 Gyro: Connector 2 pin 2,4 Signal: Connector 2 pin 6
Pressure Sensor (Analog Input)	Signal: Connector 1 pin 6
Temperature Sensor (Digital Input)	Signal: Connector 1 pin 1

After all testing done, the integrated sensors can be attached to Unmanned Underwater Vehicle that have been developed Underwater Technology Research Group (UTeRG) research team as shown in Figure 4 that called as “TUAH” Autonomous Underwater Vehicle (AUV).

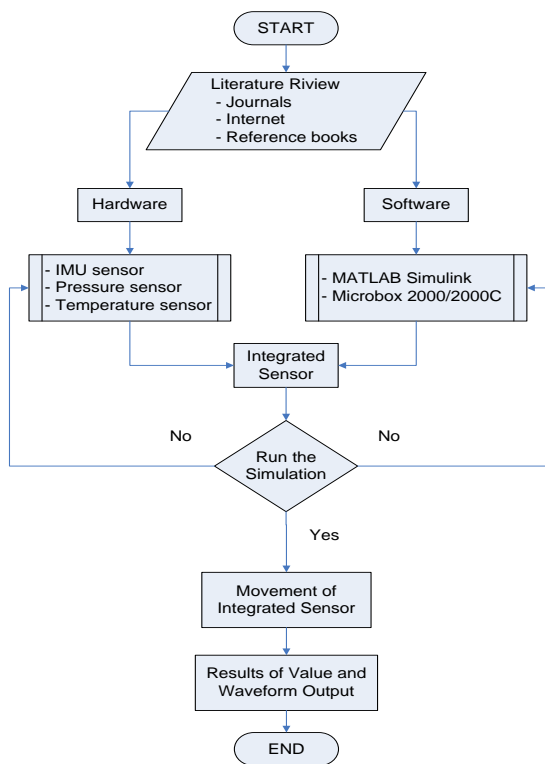
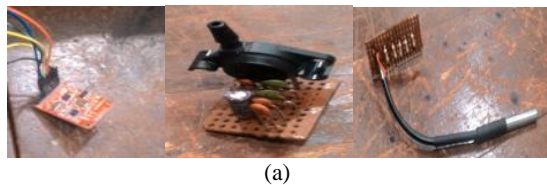

Fig.1 - Process flow chart.



(a)



(b)

Fig.2 - Integrated sensor

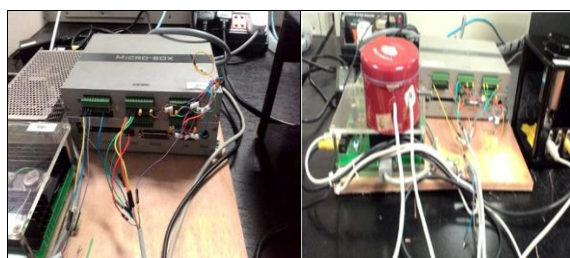

(a)

(b)

Fig.3 - The MicroBox pin connections of input and output from Integrated Sensor



(a)

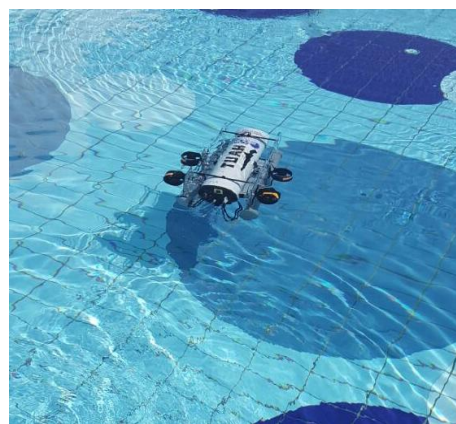

(b)

Fig.4 - “TUAH” Autonomous Underwater Vehicle (AUV)

Results and Discussion

The actual values may slightly differ from the absolute value due to the effects of the environment or condition during the experiment conducted. In this part, the results of the theoretical method are

compared with the results of the real-time method where the final output is discussed in details. Figure 3 shows the final design of integrated sensor that already connected to an Ethernet cable (data cable) and sealed to prevent water from entering through the drilled hole in order to remove the nozzle pressure and temperature sensors. Table 2 shows the characteristic design of casing for the integrated sensor.

Simulation Design of Real-Time in MATLAB

Figure 5 shows the simulation design of integrated sensor that contained three sensors, which are IMU, pressure and temperature sensors. There are two types of input, which are analogue and digital input sensors. The analogue inputs are IMU and pressure sensors and the digital input is a temperature sensor. All of the input based on the data sheet.

Integrated Sensor Results using MicroBox 2000/2000C

The value of all sensors is equal to zero when the MATLAB Simulink runs by interfacing of MicroBox 2000/2000C. Figure 6 shows the initial output waveform for accelerometer, gyroscope, pressure and temperature sensors. The Figure 7(a) shows Y-axis rotate in -45° condition. The Figure 7(b) shows the X and Y-axis rotate in 90° condition, but the rotations are not constant when the Y-axis have an increasing rotate in 0.1s due to the offset error occurs. The offset error of accelerometer is 0.1 to 0.5.

Figure 8 shows the output graph of pressure sensors. Figure 8(a) shows the output pressure graph have not much changes due to the lack of pressure applied. Means that, the pressure occurs in 0.75s and increased rapidly until 0.5v. The Figure 8(b) shows the pressure occurs are static, whereas it still maintains in 0.5v for 1s. The output of temperature in discrete time because it is in digital input and the binary values needed to convert in $^\circ\text{C}$ unit based on the data sheet. The output graphs of the temperature sensor as shown in Figure 9(a) for initial temperature output and Figure 9(b) for final temperature output. Figure 10 shows the output graph of temperature sensors.

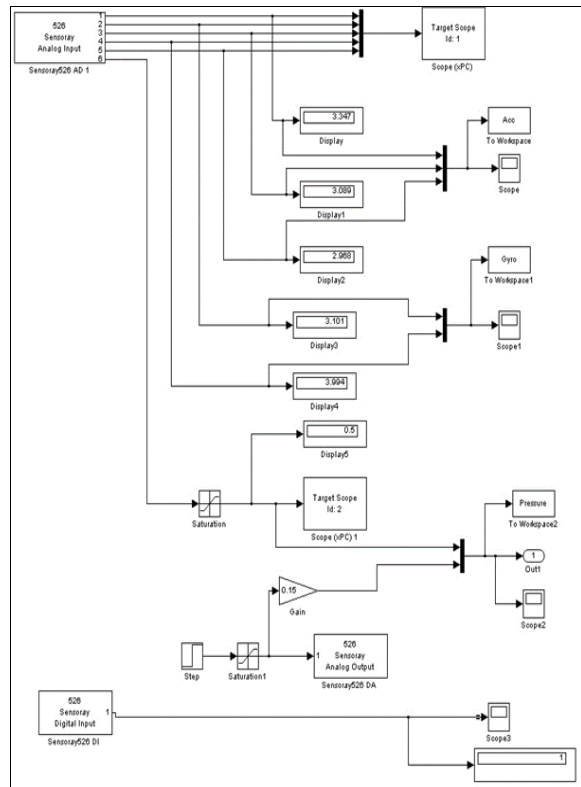

Fig.5 - Simulation design of integrated sensor.



(a)



(b)

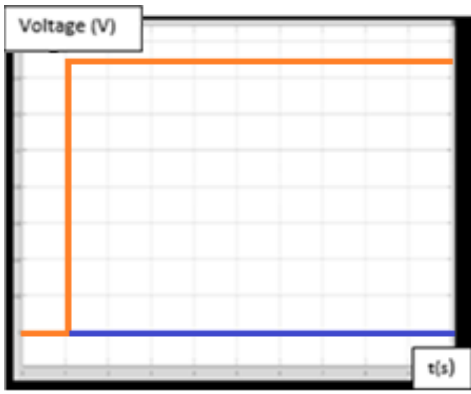

(c)

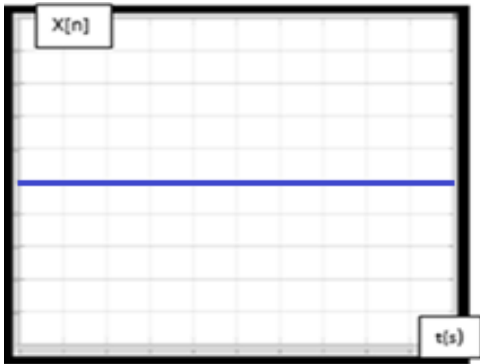

(d)

Fig.6 - The initial output waveform for integrated sensor: a. acceleration, b. gyroscope, c. pressure sensor, d. temperature sensor.

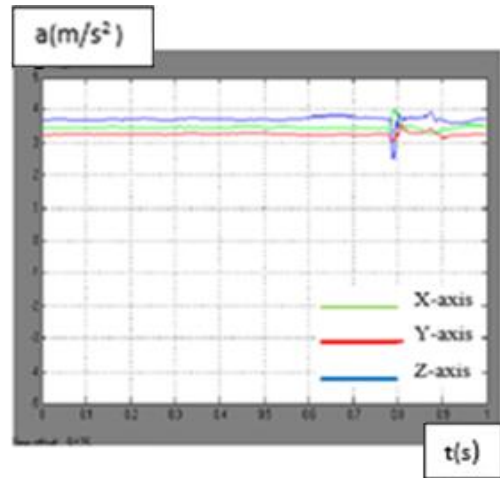

(b)

Fig.7 - The output waveform of accelerometer; a. 45° movement, b. 90° movement.

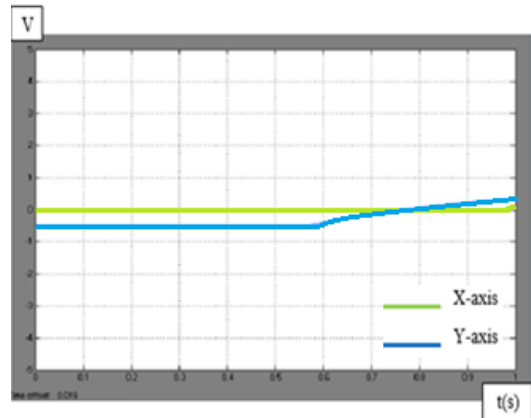

(a)

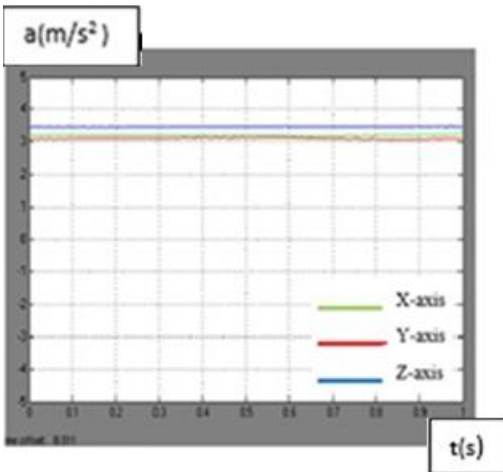

(a)

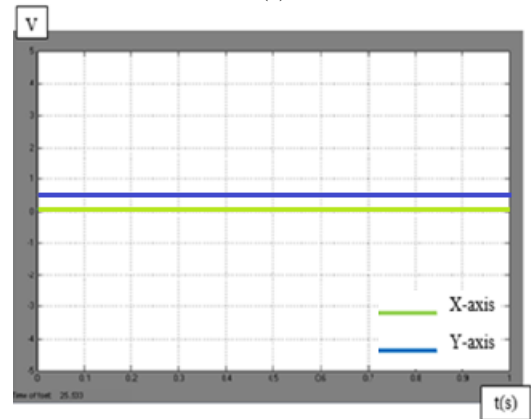

(b)

Fig.8 - The output waveforms of pressure sensor; a. high pressure applied in sensor, b. low pressure applied in sensor.

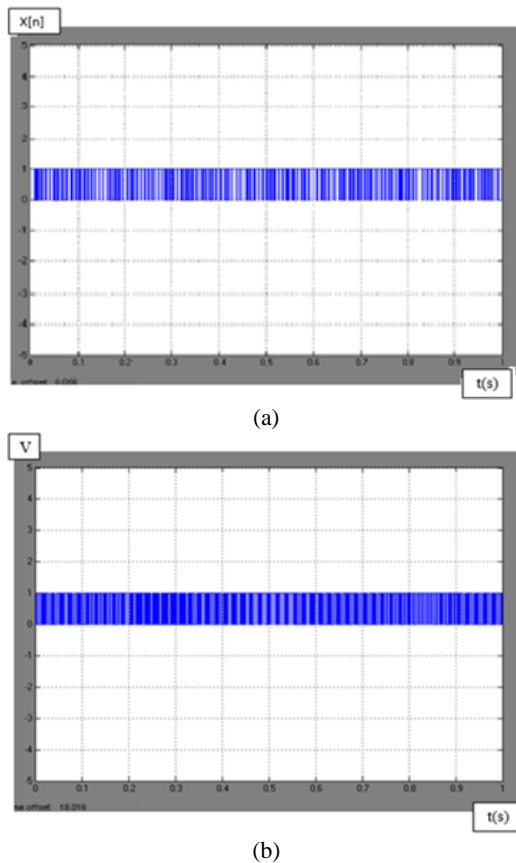

Fig.9 - The output waveforms of temperature sensors; a. initial temperature, b. final temperature.

Analysis of Sensors

The analysis of sensors needed to compare with the actual results and theoretical results based on the graph and formula to find the accuracy and error of the final experimental output results. The analysis is emphasising about the types of condition and environment occurs. There are three sensors are involved in analysis, which are IMU sensor, pressure sensor, and a temperature sensor. In Figure 11 and Figure 12 shows the movement of the accelerometer and rotation of gyroscopes based on the X, Y, and Z-axis. Based on the output waveform, there are two factors that affect the output graph; the gravitational force and offset errors. The gravitational force is the axis that align in Z-axis with having an error of measurement in normal condition. The offset error is the reading of zero condition that occurs in measurement. The result of split graph easier to find the offset error and gravitational force because the graph of accelerometer not combined with gyroscopes by

comparing the split of the output graph. Otherwise, the values for every movement measured in 0.1s by ignoring the output graph of gyroscopes.

Axis	Reading 1	Reading 2	Reading 3	Average values
X	-9.98	-10.2	-10.1	-10.1
Y	0.72	0.70	0.68	0.7
Z	-0.17	-0.22	-0.18	-0.19

Axis	Reading 1	Reading 2	Reading 3	Average values
X	-0.02	-0.06	-0.04	-0.04
Y	-8.97	-9.18	-9.20	-9.11
Z	-0.48	-0.50	-0.52	-0.50

Axis	Reading 1	Reading 2	Reading 3	Average values
X	-0.48	-0.46	-0.52	-0.49
Y	0.79	0.76	0.82	0.79
Z	-10.30	-10.50	-10.40	-10.40

The gravitational force measured by comparing the highest of average values Z-axis in table 3, table 4 and table 5. From table 5, the average readings of Z-axis are $-10.40 m/s^2$. Based on the acceleration of gravitational force, $-9.81 m/s^2$. The offset error in equation (2).

$$-9.81 m/s^2 - (-10.40 m/s^2) = 0.60 m/s^2$$

From Equation 2, the gravitational force for the IMU sensor is $+0.60 m/s^2$. Then, the IMU sensor will test again to find the percentages of offset error as shown in Table 6.

Axis	X	Y	Z	Highest values
X	-9.78	0.39	0.46	-9.78
Y	0.38	-9.82	-0.87	-9.82
Z	-0.29	0.32	-9.84	-9.84

Based on the measuring values of the readings accelerometer of X, Y and Z-axis, the highest values of every axis used to find an offset error.

X-axis:
$$\frac{-9.81\text{m/s}^2 - (9.78)\text{m/s}^2}{-9.81\text{m/s}^2 \times 100\%} = 0.3\% \quad (3)$$

Y-axis:
$$\frac{-9.81\text{m/s}^2 - (-9.82)\text{m/s}^2}{-9.81\text{m/s}^2 \times 100\%} = -0.1\% \quad (4)$$

Z-axis:
$$\frac{-9.81\text{m/s}^2 - (-9.84)\text{m/s}^2}{-9.81\text{m/s}^2 \times 100\%} = -0.3\% \quad (5)$$

The result shows that X, Y, and Z-axis error is between -0.3% to +0.3%. The result is acceptable because the error is small and the actual result is not affected. So, the IMU sensor is suitable to apply in underwater vehicles by referring the result that tested.

Pressure Sensor

Based on the Table 7, the pressure averages, P_{avg} values and voltages averages, V_{avg} can be measured as shown in Equation 6 and Equation 7.

At depth: output pressure of 3.6576m

$$P_{avg} = \frac{(240+250+260+260+270+280+290+290+300+300+300+310)+310+320}{11} \text{ kPa} \quad (6)$$

= 282.31 kPa

At depth: output pressure of 3.6576m

$$V_{avg} = \frac{(1.618 + 1.683 + 1.726 + 1.772 + 1.808 + 1.855 + 1.900 + 1.944 + 2.013 + 2.042 + 2.015 + 2.165 + 2.217)}{11} \text{ V} \quad (7)$$

= 1.74 V

(2)

The error of the pressure sensor defined as Equation 8.

$$\text{Error} = \left| \frac{P_{theory}(\text{kPa}) - P_{calculate}(\text{kPa})}{P_{theory}(\text{kPa})} \right| \quad (8)$$

The theoretical value of pressure obtained by converting the depth of water into the pressure value. The first value of 0m that obtained from the pressure sensor settled as a reference value. The calculation of other different depth continued by using the Equation 8. The characteristic graph is plotted to get the pressure value by using excel based on the given specification of the MPX5700AP sensor. Figure 10 shows the plotted characteristic graph of the pressure sensor.

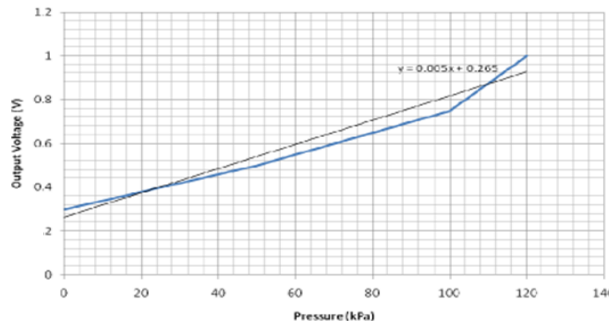

Fig.10 - The plotted characteristic graph of the pressure sensor.

Table 7 - The output pressure in small aquarium

Output voltage (V)	Pressure (kPa)
1.618	240
1.683	250
1.726	260
1.772	260
1.808	270
1.855	280
1.900	290
1.944	290
2.013	300
2.042	300
2.015	300
2.165	310
2.217	320

The equation obtained from the plotted characteristic graph in Figure 10. The pressure value defined as Equation 9. Whereas the equation is obtained, $Y = 0.0055X + 0.265$ for the output voltage. The value for first calculation is set as a reference value. So, X = pressure value (kPa).

The pressure value, P(kPa):

$$P = \frac{Y - 0.265}{0.0055} \quad (9)$$

he reference pressure, P_{ref} (kPa):

$$P_{ref} = \frac{1.618 - 0.265}{0.0055} = 246 \text{ kPa} \quad (10)$$

There are two experiments are obtained. The first experiment is using an air compressor and followed by using the aquarium. The error percentages of pressure sensor for each depth calculated by using Equation 8.

The percentage of error by using an air compressor:

$$\% \text{ of error} = \text{error} \times 100\% \quad (11)$$

$$\text{error} = \left(\frac{250 - 270}{250} \right) \text{kPa} \times 100\% = \pm 8\%$$

The percentage of error by using aquarium:

$$\% \text{ of error} = \text{error} \times 100\%$$

$$\text{error} = \left(\frac{280 - 297.27}{280} \right) \text{kPa} \times 100\% \quad (12)$$

$$= \pm 6.17\%$$

Temperature Sensor

Figure 11 shows the output result of temperature in one second. For each of one second, it contains a 12-bit resolution. The binary number is 1111 1111 1000 by assuming the zero bit as a white colour and one bit as a blue colour. The temperature sensor is tested using two types of water, which are cold water and warm water in an aquarium.

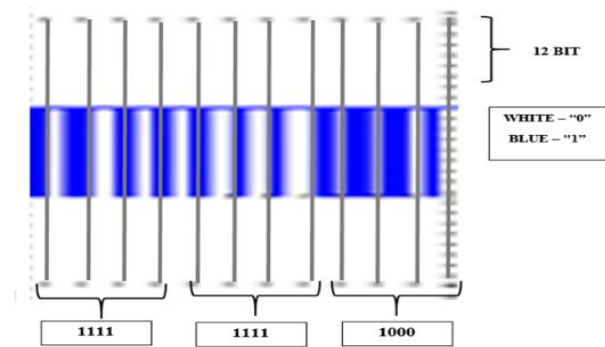

Fig.11 - The output binary values.

The temperature is increased when the depth of water increase. The output graph plotted by comparing the output temperature of warm water and cold water in a small aquarium. The comparison graph between the warm and cold water of temperature output values as shown in Figure 12.

In Figure 12, the output graph of both two types of water almost has the same pattern, but the differences are in negative and positive values of output temperature. It shows that from the 0ft. until to 5ft., the values of temperature are $\pm 0.5^\circ\text{C}$ for both of warm and cold water. The graph shows in 10ft, the temperature in cold water is decreased to -25.0625°C and the temperature in warm water is increased to $+25.0625^\circ\text{C}$ at 11ft. From the comparison, the error performance of the temperature sensor is ± 0.5 .

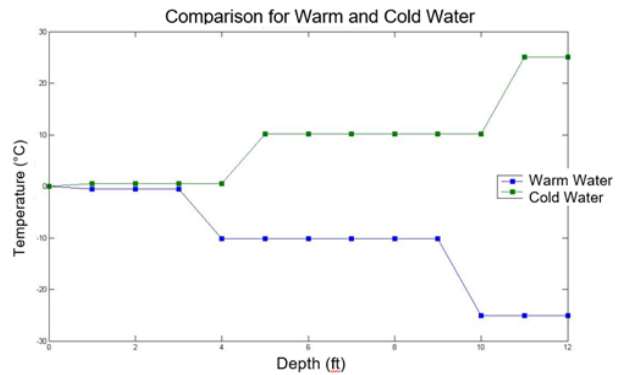

Fig.12 - The comparison graph between warm and cold water of temperature output values.

Conclusion

Integrated Sensors for underwater vehicle developed to solve problems that occur in current sensor system. There are three types of sensors integrated together, which are Inertia Measurement Unit (IMU), temperature sensor and a pressure sensor. All these sensors interface with MicroBox 2000/2000C and connected with MATLAB software. The data obtained shows that the errors are between -0.3% to $+0.3\%$. For the pressure sensor, the error is $\pm 6.17\%$ and for the temperature error is $\pm 0.5\%$. Based on the percentages of error, the error occurs in IMU sensor, pressure sensor and temperature sensor are small.

Acknowledgment

We wish to express our gratitude to honorable University, Universiti Teknikal Malaysia Melaka (UTeM). Special appreciation and gratitude to especially for Underwater Technology Research Group (UTeRG), Centre of Research and Innovation Management (CRIM), Center for Robotics and Industrial Automation (CERIA) for supporting this research and to Faculty of Electrical Engineering from UTeM and Ministry of Higher Education for supporting this research under FRGS. (FRGS/1/2015/TK04/FKE/02/F00257).

References

1. J. Heidemann, M. Stojanovic, M. Zorzi, "Underwater sensor networks: applications, advances and challenges", 2011 The Royal Society, DOI: 10.1098/rsta.2011.0214, USA, 28 November 2011
2. Farr, N.Bowen, A.Ware, J. Pontbriand, C. Tivey, "An integrated, underwater optical and acoustic communications system", OCEANS 2010 IEEE-Sydney, ISBN: 978-1-4244-5221-7, Sydney, NSW, 24-27 May 2010.
3. Randeniya, S. Sarkar, M. Gunaratne, "Vision-IMU Integration Using a Slow-Frame-Rate Monocular Vision System in an Actual Roadway Setting", Intelligent

- Transportation Systems, IEEE Transactions on (Volume: 11, Issue: 2), ISSN: 1524-9050, 8 January 2010
4. M. Rowe, "Sensor basics: Types, functions and applications", UBM Canon Electronics Engineering Communities, Santa Clara, 12 September 2013
 5. A. Koyun, E. Ahlatcıoğlu, Y. Koca, "Biosensors and Their Principles", Science and Technology Application and Research Center, Turkey, 2011
 6. J.Fraden, "Handbook of Modern Sensors: Physics, Designs, and Applications", 5th Edition, Springer, ISBN: 3319193031, 9783319193038, 15 October 2015
 7. D. Patranabi, "Sensors and Transducers" 2nd Edition, PHI Learning Pvt. Ltd., 2003, ISBN: 8120321987, 9788120321984, 1 January 2003
 8. S. J. Wilson, "Sensor Technology Handbook- Volume 1", Newnes, ISBN: 0750677295, 9780750677295, 2005
 9. M.S.M Aras, S.S. Abdullah, S.S. Shafei, M.Z.A Rashid, A. Jamali "Investigation and evaluation of low cost depth sensor system using pressure sensor for unmanned underwater vehicle", Majlesi Journal of Electrical Engineering, Melaka, Malaysia Volume 6, Number 2, June 2012
 10. M.S.M. Aras, M.F. Basar, S.S. Abdullah, F.A. Azis, F.A. Ali, "Analysis Movement of Unmanned Underwater Vehicle using the Inertial Measurement Unit", International Journal of Emerging Science and Engineering (IJESE), ISSN: 2319-6378, Volume-1, Issue-10, August 2013.
 11. Mohamad Haniff Harun, Mohd Shahrieel Mohd Aras, Mohd Farriz Md. Basar, Shahrums Shah Abdullah, Khalil Azha Mohd Annuar, Synchronization of Compass Module with Pressure and Temperature Sensor System for Autonomous Underwater Vehicle (AUV), Jurnal Terknologi, 74:9 (2015), 161-167, 2015.
 12. M.S.M Aras, S.S. Abdullah, A.F Nizam M.F Basar, A. M. Kassim, H.I. Jaafar, "Analysis of movement for unmanned underwater vehicle using a low cost integrated sensor", AIP Conf. Proc. 1660, 070052, Penang, Malaysia, 28-30 May 2014
 13. G.C Angelosanto, "Kalman Filtering of IMU Sensor for Robot Balance Control", Massachusetts Institute of Technology, Department of Mechanical Engineering, 2008.
 14. Mohd Shahrieel Mohd Aras, Fadilah Abdul Azis, Shahrums Shah Abdullah, Lee Dai Cong, Lim Wee Teck, Fara Ashikin Ali, Muhammad Nur Othman, Study on the Effect of Shifting 'Zero' in Output Membership Function on Fuzzy Logic Controller of The ROV using Micro-Box Interfacing Jurnal Terknologi, 74:9 (2015), 119-128, 2015.
 15. Mohd Aras, Mohd Shahrieel and Abdullah, Shahrums Shah and Baharin, Kyairul Azmi and Mohd Nor, Arfah Syahida and Mohd Zambri, Mohd Khairi (2015) *Model identification of an underwater remotely operated vehicle using system identification approach based on NNPC*. International Review of Automatic Control (IREACO), 8 (2). pp. 149-154. ISSN 1974-6059
 16. Mohd Aras, Mohd Shahrieel and Abdul Rahman, Ahmad Fadzli Nizam (2013) *Analysis of an Improved Single Input Fuzzy Logic Controller Designed For Depth Control Using Microbox 2000/2000c Interfacing*. International Review of Automatic Control, 6 (6). pp. 728-733. ISSN 1974-6059
 17. Mohd Aras, Mohd Shahrieel, Shahrums Shah Abdullah, Mohd Shah, Hairol Nizam and Ab Rashid, Mohd Zamzuri (2013) *Robust Control Of Adaptive Single Input Fuzzy Logic Controller For Unmanned Underwater Vehicle*. Journal of Theoretical and Applied Information Technology, 57 (3). pp. 372-379. ISSN 1992-8645
 18. Y. Sergey, "Sensors and Signals", IFSA (International Frequency Sensor Association Publishing), ISBN: 8460823202, 9788460823209, 2015
 19. S. J. Wilson, "Sensor Technology Handbook- Volume 1", Newnes, ISBN: 0750677295, 9780750677295, 2005
 20. Joseph J. Suter, "Sensors and sensor Systems research and development at APL with a view toward the future", Volume 26, Number 4, APL Technical Digest, 2005
 21. N. Isaac N. Bankman, Joseph J. Suter, "Living with sensors at APL", Volume 24, Number 1, APL Technical Digest, 2003
 22. P.D. Groves, "Principles of GNSS, Inertial, and Multisensor Integrated Navigation Systems- 2nd Edition", Artech House, ISBN: 1608070050, 9781608070053, 2013
 23. D. Tandeske, "Pressure Sensors: Selection and Application", CRC Press, ISBN: 0824783654, 9780824783655, 1990.
 24. K. Bekt, "Archimedes' Principle and Buoyancy", 2015 Prezi Inc, University Physics, 29 November 2012.
 25. C. Gorse, D. Johnston, M. Pritchard, "A Dictionary of Construction, Surveying and Civil Engineering", Oxford University Press, ISBN-13: 978019953446, 2012.
 26. Localization in Underwater Sensor Networks", Australasian Telecommunication Networks and Applications Conference (ATNAC), 2011, ISBN: 978-1-4577-1710-9, Kharagpur, India, 9-11 November 2011.