



e-ISSN: 2147-8228

www.dergipark.org.tr/ijamec

Volume 10
Issue 01

March, 2022

*Research Article***Prototyping of a Novel Thruster for Underwater ROVs****Gokhan Atali** ^a ^a*Department of Mechatronics Engineering, Faculty of Technology, Sakarya University of Applied Sciences, Sakarya 54050, Turkey*

ARTICLE INFO

Article history:

Received 25 December 2021

Accepted 9 January 2022

Keywords:

Fluid analysis

ROVs

Thruster

Underwater

ABSTRACT

Underwater vehicles are expected to have flexible maneuverability to perform various tasks such as security, reconnaissance, and search rescue. This maneuverability depends on the thruster to perform the specified tasks effectively. The designs of the propeller and the duct in the thrusters have a significant effect on the vehicle's mobility as it directly affects the thrust force. An ergonomic design is aimed by choosing the optimum level in terms of efficiency for the number of propeller blades. In addition, a duct design is needed to prevent water escape due to propeller movement.

In this study, an original thruster has been designed by making theoretical calculations. The designed thruster has been analyzed using the Finite Element Analysis (FEA) method. The thrust, friction, torque, and efficiency values of the developed thruster have been calculated using momentum theory and supported by fluid mechanics analysis. In line with the analyses, the prototype of the designed thruster has been manufactured and the necessary performance tests were carried out on an autonomous underwater vehicle named Fersah-ROV, which was also originally designed and manufactured.

This is an open access article under the CC BY-SA 4.0 license.
(<https://creativecommons.org/licenses/by-sa/4.0/>)

1. Introduction

Unmanned underwater vehicles are currently used in underwater cleaning, repair, research, port security and military technologies. These vehicles increase success in various tasks by targeting points that people cannot reach. Thrusters, one of the most important components of unmanned underwater vehicles, are electromechanical elements that create the propulsion force that will ensure the movement of the vehicle. The thrust that directly affects the vehicle's mobility and maneuverability; depends on selected engine, propeller design and hydrodynamic effects.

Huy et al. presented the design, analysis, and control of a thruster for an unmanned underwater vehicle in their study. While designing their thruster and control algorithm, long-term use of the vehicle under water has been considered [1]. Song and Arshad modeled a propeller for a HAUV (Hovered Unmanned Underwater Vehicle) in their work. By doing Bollard-pull experiments, they have been observed the relationship between the axial forces generated by the thrusters and the input signal given to the Arduino Uno

board. These experiments have been showed that the loss of propeller efficiency is due to the contact of the propeller with the vehicle body [2]. Luo et al. used Gaussian process regression, which considers the cavitation effect, to create a thruster model. They have been verified the effectiveness of this model they created with proof-of-concept experiments, and the results of these experiments showed that the proposed model had fewer errors than the traditional model [3]. Gungor has been modeled the flow noise produced by an underwater vehicle in digital environment using LES (Large Edge Simulation). In addition, he has been analyzed the noise spectra and acoustic traces under water and compared the results of different speed, rpm and torque values using the 4382 propeller [4]. In their study, Hsieh et al. have been presented a rim-driven thruster and driver integrated design for a ROV (Remote Controlled Underwater Vehicle). The designed thruster has been produced as a prototype and tested. Tests have shown that the prototype produced has been reached an acceptable performance and the study has been completed successfully [5]. Healey et al., in their study, introduced a new approach to the propeller by modeling the

* Corresponding author. E-mail address: gatali@subu.edu.tr
DOI: 10.18100/ijamec.1045491

quarter dynamic response of the thrusters used for motion control of ROV and AUV (Autonomous Underwater Vehicle) vehicles [6].

In this study, a thruster has been designed for unmanned underwater vehicles and its theoretical calculations have been presented. The designed thruster has been analyzed using the finite element method. The prototype of the thruster, which was analyzed and simulated, has been produced and the necessary tests have been carried out on the underwater vehicle named Fersah-ROV, which is shown in Figure 1.

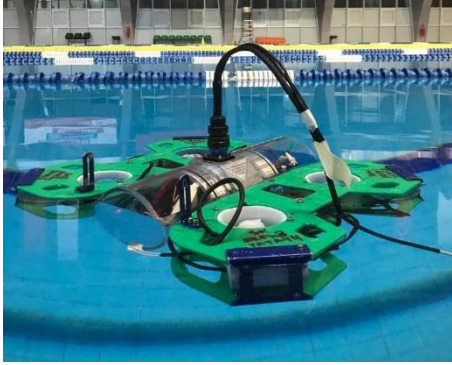

Figure 1. Fersah-ROV autonomous underwater vehicle

2. Experimental Work

2.1. Thruster Force Calculations

Total thrust, duct friction force, theoretical maximum efficiency and thrust constant calculations of the designed thrust system have been made. Momentum theory and propeller theory have been used in the calculations made considering the changes in kinetic energy and momentum.

2.1.1. Thrust Calculation for Ducted Propeller

Since the ducted propellers move more liquid, they increase the efficiency depending on the flow rate. In ducted propellers, the change in momentum has been used for calculating the total thrust.

The area of the propeller disc (A_p), which will be used when calculating the total thrust as in 1, has been calculated in the CAD environment and 0.00428434 m^2 determined. The velocity added in the flow (U_a) and the velocity of the fluid along the disk (V_p) have been obtained with the simulation tool as 2.3 m/s and 4 m/s , respectively. By substituting these values in Equation 1, the total thrust force has been found to be 39.29 N .

$$T_0 = \rho * A_p \left(V + \frac{U_a}{2} + \delta \right) * U_a \quad (1)$$

Table 1. Abbreviation table

Abbreviation	Definition	SI
T_0	Total thrust	N
δ	Duct induced velocity	m/s
V_p	Velocity through propeller disk	m/s
V	Velocity of the fluid before enters the propeller	m/s
A_p	Area of the propeller disk	m^2
U_a	Added velocity in flow behind propeller	m/s
ρ	Density	kg/m^3
K_T	Thrust Coefficient	N
n	Number of revolutions	rev/s
D	Propeller diameter	m

2.1.2. Frictional Force of the Duct

The C_d coefficient has been calculated for water using SolidWorks flow simulation and it has been accepted as 0.58 by showing the analysis result in Figure 2.

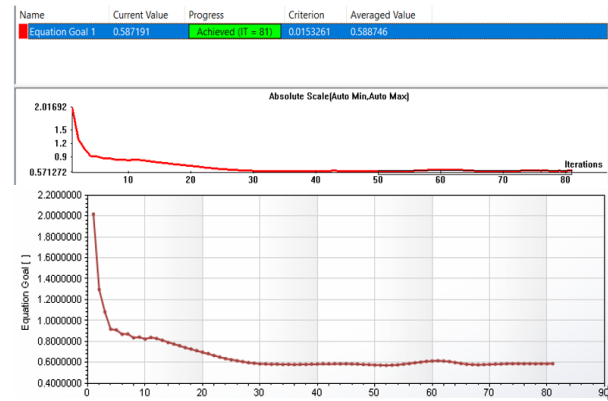

Figure 2. C_d parameter

$$D_f = 0.5(\rho C_d A_p V_p) \quad (2)$$

The friction force (D_f) of the channel has been calculated using Equation 2 and found 4.95 N .

2.1.3. Calculation of the Frictional Efficiency of the Duct

While calculating the friction efficiency of the duct, the total thrust force value (T_0) calculated in Equation 1 and the friction force value (D_f) calculated in Equation 2 have been used in Equation 3 to find the efficiency (η_f) 87%.

$$\eta_f = \frac{T_0 - D_f}{T_0} \quad (3)$$

2.1.4. Calculation of Thrust Coefficient

The thrust constant (K_T) has been calculated by substituting the required values in Equation 4. The thrust constant has been found to be 0.29 by taking the number of revolutions (n) as 95.17 rev/s and the diameter of the propeller (D) as 0.06199 m .

$$K_T = \frac{T_0}{\rho n^2 D^4} \quad (4)$$

2.2. Design of the Thruster

As the propeller rotates in unmanned underwater vehicles, high-pressure and low-pressure areas have been formed between the blades. While the thrust required for the movement of the vehicle underwater is formed, the fluid moves from the high-pressure area to the low-pressure area with this pressure difference. The thruster, which is shown in Figure 3, consists of an engine, propeller, and propeller duct. Increasing the number of propeller blades provides an increase in the thrust force and torque produced. However, this also negatively increases the power required to operate the rotor [7]. Considering the power required to be produced by the engine, the propeller has been designed with 3 blades.

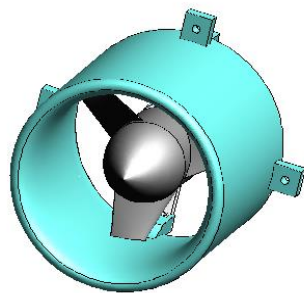

Figure 3. The design of the thruster

During the propeller movement, losses occur at the tips of the propeller blades as the fluid moves from the high-pressure area of the blade to the low-pressure area. To reduce these losses, a duct has been designed around the propeller. While designing the duct, it has been aimed to give the duct an aerodynamic structure to increase the efficiency of the design. The designed duct has a curved surface towards the impeller outlet. With the geometric shape of the design, it has been aimed to increase the velocity of the constant density fluid as it exits the channel. Channels contribute to the increase of the damping effect during maneuvers and affect the maneuverability of the vehicle in a supportive way [8]. In Figure 4, the technical drawings of the designed thruster are shown.

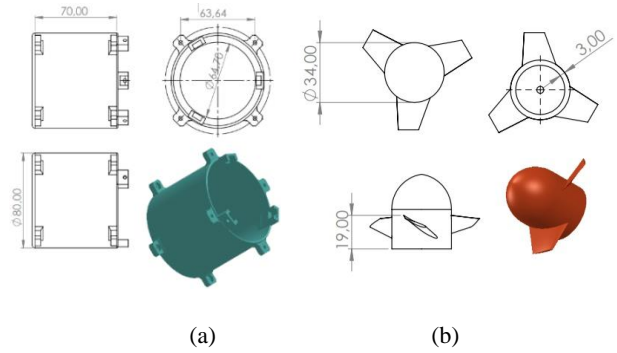

Figure 4. a) Thruster duct design technical drawings, b) Propeller design technical drawings

2.3. Finite Element Method

The finite element analysis method solves complex problems by simplifying, based on the principle of breaking up the space into small parts. The thruster designed in this study has been analyzed using the finite element analysis method in the SolidWorks Fluid Analysis tool.

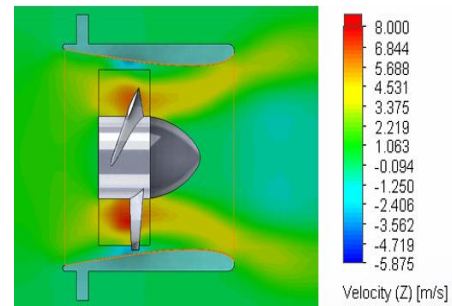

Figure 5. Water flow rate analysis

The results of the velocity and thrust analysis of the thruster have been shown in Figure 5. This flow, created by the rotation of the propeller, created the thrust of the thruster. This thrust force reached 8 m/s speeds in the center of the propeller, and it was observed that it had an average speed of 4.5 m/s at the exit.

Table 2. The thrust data of thruster

Thrust	SI	Average Value	Minimum Value	Maximum Value
Propeller thrust	N	25,01901713	24,62844874	25,29796551
Duct thrust	N	5,695969359	5,303645961	6,096618837
Total thrust	N	30,71498649	30,53124303	30,943021

The results of the simulation are as in Table 2. The designed thruster has an average thrust of 30.71 N. The equivalent of the thrust force in kilograms is 3.13 kg. Water flow analyzes have been presented in the simulation environment of the designed and theoretical calculations of the thruster. Because of the curved structure of the channel design, it was concluded that the water flows faster from the narrower part of the duct. The speed at the

center of the propeller reached 8 m/s, and its speed decreased as it moved towards the exit of the channel.

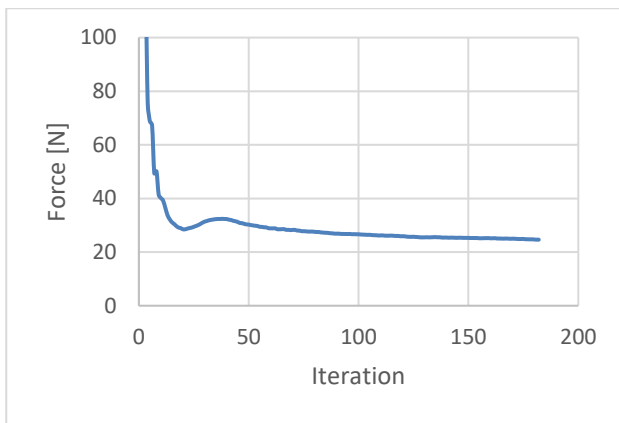

Figure 6. Propeller thrust

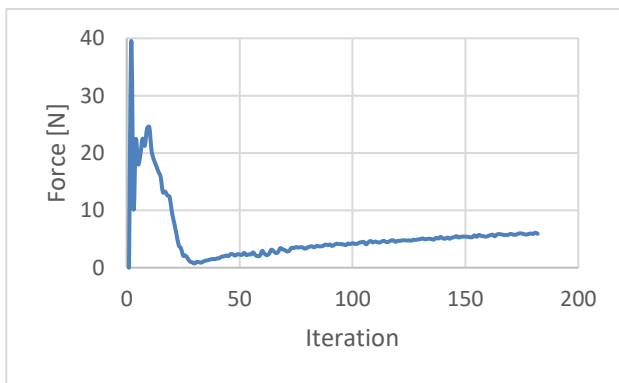

Figure 7. Duct thrust

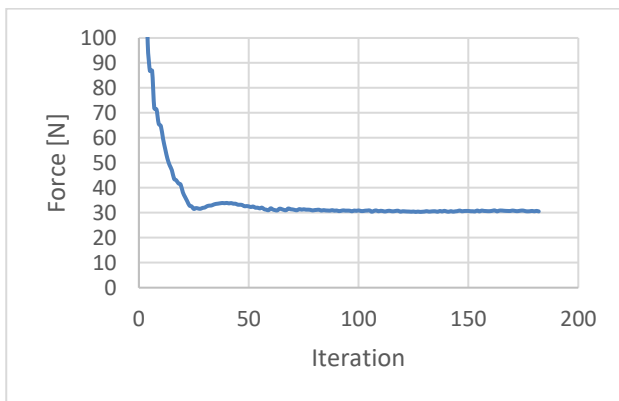

Figure 8. Total thrust

Propeller, duct and total thrust graphs are shown in Figure 6, Figure 7 and Figure 8, respectively. As can be seen in Figure 6 and Figure 8, the channel designed around the propeller prevented water to escape and increased the total thrust.

The prototype of the designed thruster has been produced and tested on the Fersah-ROV and resulted in success. In the later stages of the study, it is planned to make improvements to the existing design.

2.4. Conclusion

In this study, a novel thruster has been designed in order to increase the efficiency of ROVs mobility in the water. For this purpose, theoretical calculations, force and friction analyzes have been made. Calculation and analysis results show that the designed thruster reduced the water escape and increased the total thrust force. Because of the curved structure of the channel design, it was concluded that the water flows faster from the narrower part of the duct.

Acknowledgment

I would like to thanks Robot Technologies and Intelligent Systems Application and Research Center (ROTASAM) for providing all kinds of opportunities for the realization of this study.

References

- [1] T. N. Huy, Q. T.-D. Tran, N. D. Nguyen and H.-S. Choi, "Study on Design, Analysis and Control an Underwater Thruster for Unmanned Underwater Vehicle (UUV)," International Conference on Advanced Engineering Theory and Applications, 2018.
- [2] Y. S. Song and M. R. Arshad, "Thruster Modeling for a Hovering Autonomous Underwater Vehicle Considering Thruster-Thruster and Thruster-Hull Interaction," IEEE International Conference on Underwater System Technology: Theory and Applications (USYS), 2016.
- [3] Y. Luo, J. Tao, Z. Li, L. Ding, Z. Deng, H. Sun and X. Song, "An Accurate Cavitation Prediction Thruster Model based on Gaussian Process Regression," IEEE International Conference on Robotics and Biomimetics (ROBIO), Macao, 2017.
- [4] E. Gungor, "Hydroacoustical investigation on a generic underwater vehicle using Lighthill-Curle," Journal of The Faculty of Engineering and Architecture of Gazi University, 34, 3, 1351-1364, 2019.
- [5] M.-F. Hsieh, J.-H. Chen, Y.-H. Yeh, C.-L. Lee, P.-H. Chen, Y.-C. Hsu and Y.-H. Chen, "Integrated Design and Realization of a Hubless Rim-driven Thruster," *The 33rd Annual Conference of the IEEE Industrial Electronics Society (IECON)*, Taipei, 2007.
- [6] A. Healey, S. Rock, S. Cody, D. Miles and J. Brown, "Toward an improved understanding of thruster dynamics for underwater vehicles," IEEE Symposium on Autonomous Underwater Vehicle Technology (AUV'94), USA, Cambridge, 1994.
- [7] I. Gov, "Rotor Spacing and Blade Number Effect on the Thrust, Torque, and Power of a Coaxial Rotor," *El-Cezeri Journal of Science and Engineering*, 7, 2, pp. 487-502, 2020.
- [8] E. D. Barros and J. L. D. D. Dantas, "Effect of a propeller duct on AUV maneuverability," *Ocean Engineering*, 42, 61-70, 2012.