



PRODUCTION PLATFORM SYSTEMS

Fixed Platform Installation





Fixed Platform Installation



7,000 ton Capacity Template Leveling System

Fixed Platform Installation Process

Proven products and services designed for every stage of the fixed platform installation process

Since 1965, Oil States Industries has served the offshore industry with innovative products and services that make installation, maintenance and salvage of fixed offshore structures more efficient and economical.

Our Fixed Platform Systems Group provides proven technologies and over 45 years of expert service - resulting in confidence for our customers at every step.

More detailed specifications for all our fixed-platform products and services can be found at www.oilstates.com, or call the Oil States location nearest you.



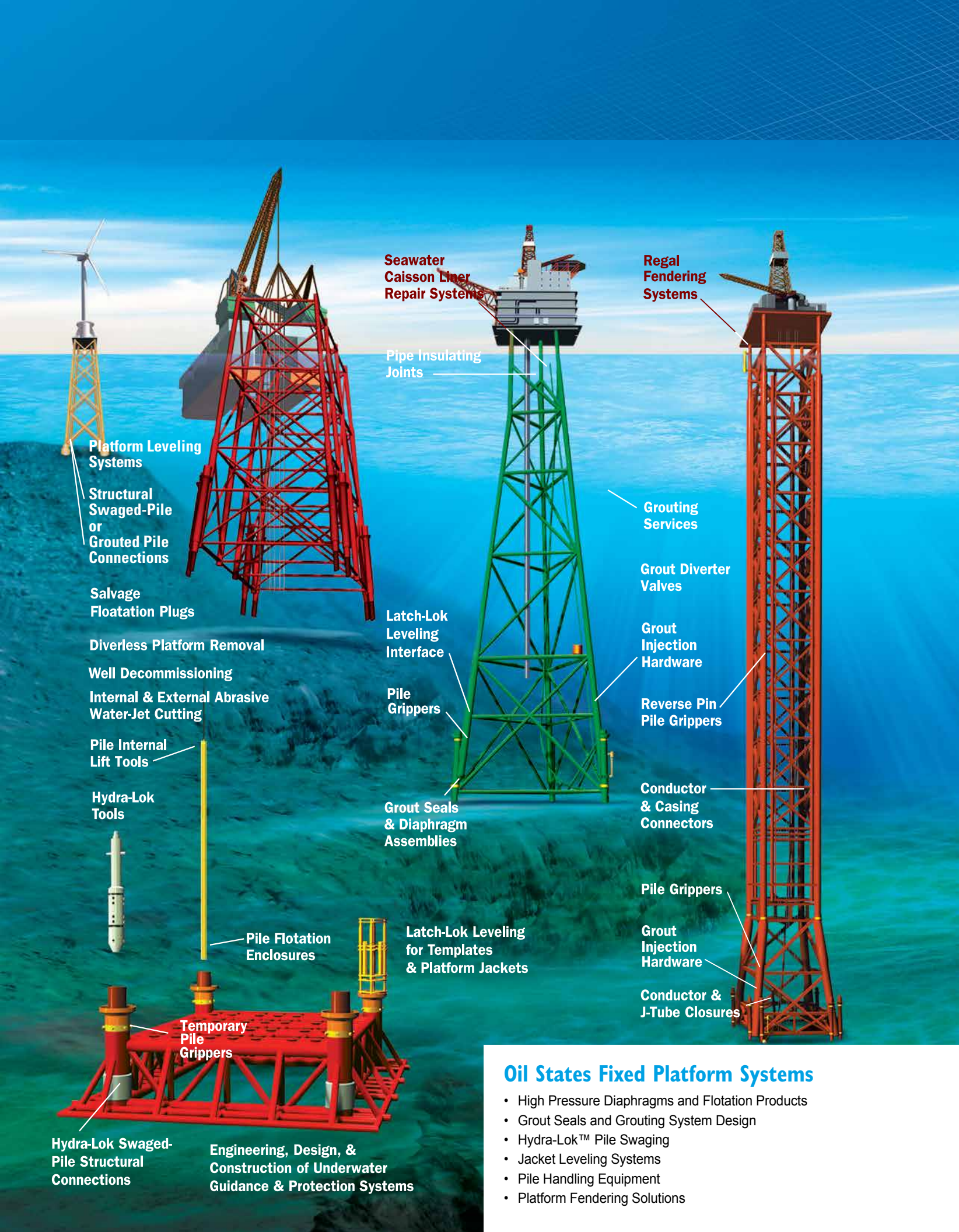

Seawater
Caisson Liner
Repair Systems

Regal
Fendering
Systems

Pipe Insulating
Joints

Platform Leveling
Systems

Structural
Swaged-Pile
or
Grouted Pile
Connections

Grouting
Services

Salvage
Floatation Plugs

Diverless Platform Removal

Grout Diverter
Valves

Well Decommissioning

Internal & External Abrasive
Water-Jet Cutting

Latch-Lok
Leveling
Interface

Grout
Injection
Hardware

Pile Internal
Lift Tools

Pile
Grippers

Reverse Pin
Pile Grippers

Hydra-Lok
Tools

Grout Seals
& Diaphragm
Assemblies

Conductor
& Casing
Connectors



Pile Flotation
Enclosures

Latch-Lok Leveling
for Templates
& Platform Jackets

Pile Grippers

Grout
Injection
Hardware

Temporary
Pile
Grippers

Conductor &
J-Tube Closures

Hydra-Lok Swaged-
Pile Structural
Connections

Engineering, Design, &
Construction of Underwater
Guidance & Protection Systems

Oil States Fixed Platform Systems

- High Pressure Diaphragms and Flotation Products
- Grout Seals and Grouting System Design
- Hydra-Lok™ Pile Swaging
- Jacket Leveling Systems
- Pile Handling Equipment
- Platform Fendering Solutions



Fixed Platform Installation



Buoyant Skirt Pile Sleeves with Integral Skirt Pile Gripper and Latch-Rings for Latch-Lok Leveling

High-Pressure Flotation Diaphragms

Pioneered by Oil States, nylon-reinforced rubber diaphragm closures are the industry standard for sealing platform legs and skirt sleeves to provide buoyancy during jacket installation. Customized diaphragm designs are available for specialized applications and deepwater structures.

- Thousands deployed worldwide since 1965, with the best performance track record in the industry
- Successfully utilized on deep water platforms exceeding 1000 ft. and for pile diameters as large as 144"
- High pressure capabilities proven by testing to 1.5 x hydrostatic pressure
- Quickly and easily pierced by the foundation pile
- Available with integral cutting devices for special penetration applications

For other Flotation-related products visit www.oilstates.com

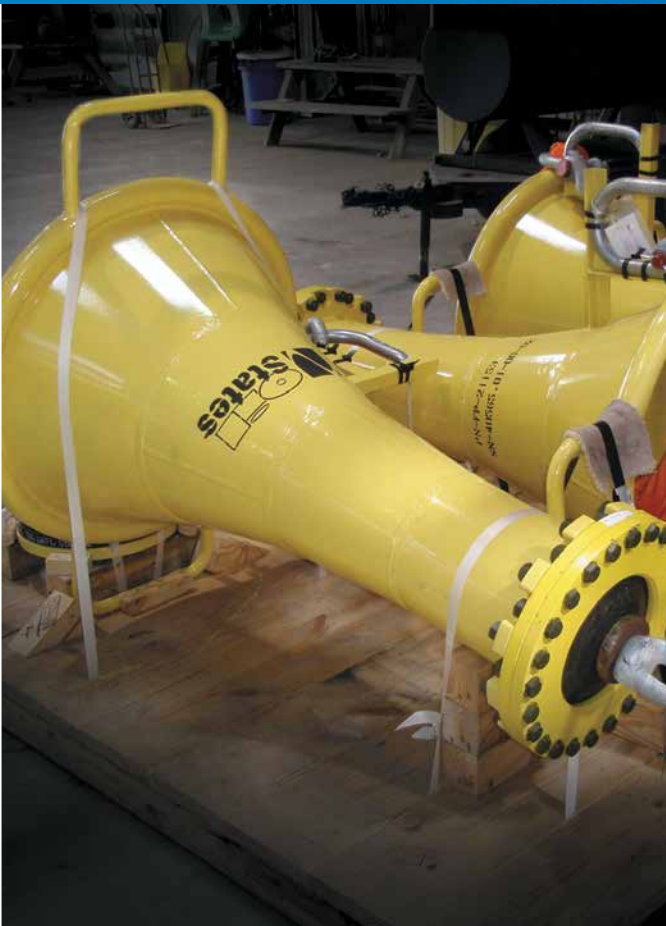

J-Tube Closures



Internal Removable Diaphragm for drilled foundation pile applications

Unmatched Reliability

More diaphragm installations than any other manufacturer

- Internal Diaphragms
- J-Tube and Caisson Plugs and Closures
- Pull-Out Plugs for Spar Hull Flooding
- Pile Flotation and Salvage Plugs
- Pressure Balanced Flood Plugs



Diaphragm Testing



Fixed Platform Installation

Structure to Foundation Pile Connection Systems

Oil States is a full-service provider of structure-to-pile connections for platform jackets and subsea templates. We offer both grout sealing systems for conventional grouting and Hydra-Lok™ technology to meet customer needs. Both are proven solutions, used for decades in diverse offshore environments.

To reduce ROV maneuvering and installation vessel movements, multiple connectors can be clustered at a convenient location on the structure. Redundant connectors can be provided for contingency packer inflation and grouting.

Grouting or Hydra-Lok? We can help.

Which connection system you choose will depend on your structure design, installation operations, water depth and other factors. Our technical team can help you make the most practical and economical choice for your project conditions. Contact us at the design phase of your project, and we can provide technical evaluations, economic analysis, design assistance and supervision and inspection as required.

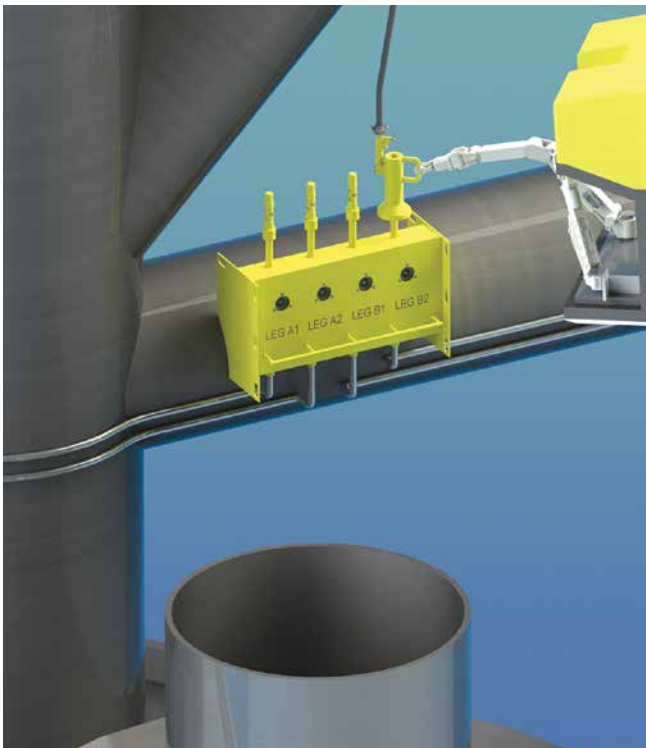
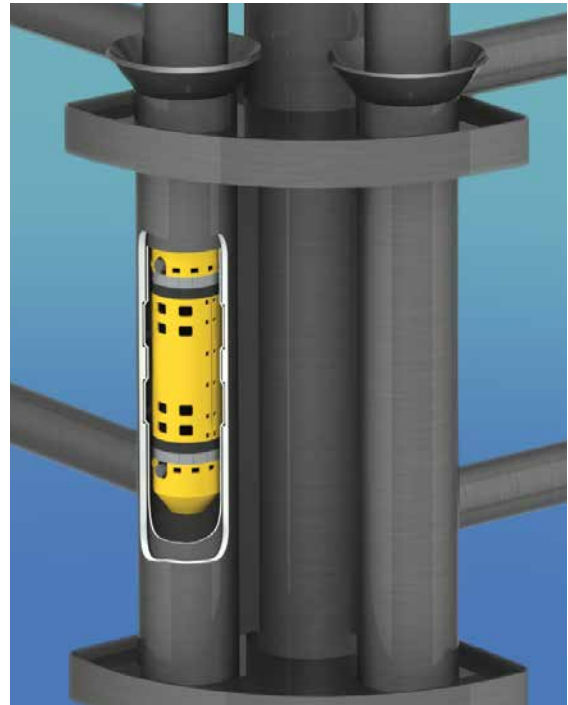

Grouting Solutions

Oil States provides complete grout seals and components, custom tailored for any offshore structure design and installation environment.

We also offer design assistance, supervision, inspection and grout placement services. For each project, we work closely with you to achieve the optimum balance between equipment cost, fabrication costs, and installation and contingency requirements. We'll help you assess factors such as water depth, sleeve configuration, number of pile sleeves and risk/budget constraints to select and deploy the right combination of grouting system components, such as:

- Grout containment products (inflatable packers and passive seals)
- ROV grout hot stabs, check valves, rupture discs and diverter valves
- Mud-barrier diaphragms and secondary seals to prevent contamination in the annulus

Inflatable Grout Packers

Inflatable Grout Packers from Oil States provide a fast, reliable and robust seal between the ID of the pile sleeve or jacket leg and the OD of the pile. These packers have been used successfully on thousands of platform jackets for more than 45 years, allowing an unlimited-height, single-stage grout column for the most efficient use of construction barge time.

A wide range of pile size options is available, and we routinely customize packers for diverse applications such as flotation plugs, salvage plugs and tunnel seals.

Inflatable Grout Packer Advantages

- High-strength, nylon-reinforced packer seal element allows one-stage grouting regardless of water depth or grout weight
- No seal contact during pile installation
- Positive packer seal can be verified by pressure monitoring
- Regular guide shims above the packer protect it during pile driving and ensure centering
- Packers are designed to withstand pile-driving vibrations and shock loads
- Packer seal element can be supplied in kit form for fabricator assembly

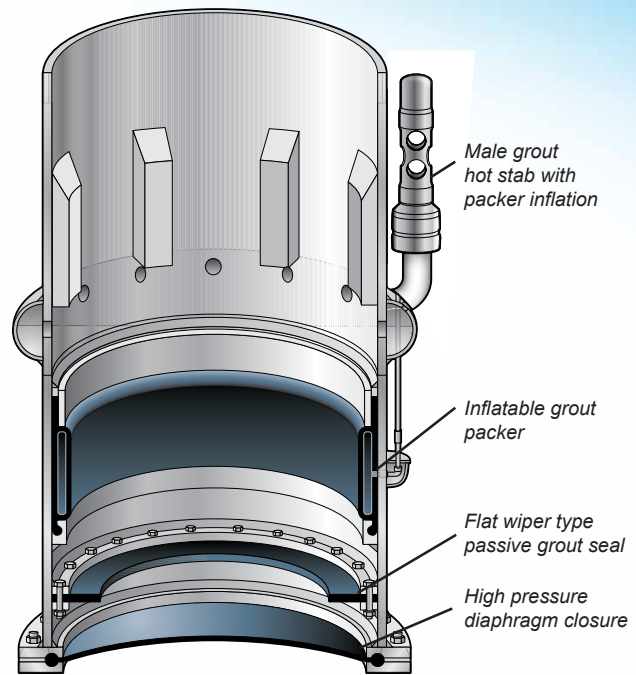

Passive Grout Seals

Passive grout seals do not require external activation methods, as they remain in contact with the pile at all times. They can provide grout holding capability for jacket legs, skirt pile sleeves, or secondary grout plug applications.

Flat Wiper Seals are typically used as a back-up seal for an inflatable grout packer, pressure-grouted jacket legs or other two-stage grouting operations.

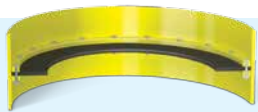

Reinforced Bulb Seals are high-capacity passive grout seals for large pile-to-sleeve annuli. A single seal supports grout columns up to 60 ft. or 100 ft. using dual seals. They are available in a finished assembly or kit form.



Single and Dual Ell Seals are designed to support grout columns from 25 to 40 ft. and are frequently used on pressure-grouted jacket legs.



Mechanical Grout Seals maintain a clean jacket/pile annulus and support grout columns up to 100 ft. This seal is typically more economical than inflatable grouting when jacket/pile geometry and installation requirements permit. They are available either mounted in a cylinder or as a kit for installation in a leg or pile sleeve.

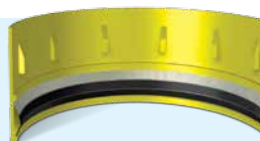

ROV-Subsea Grouting Hot Stabs

This diverless system uses an ROV to connect a surface-deployed umbilical hose to a subsea hot stab connector for both grout injection and packer inflation. The system eliminates fixed grout piping and packer inflation lines to or from the surface.

To reduce ROV maneuvering and installation vessel movements, multiple connectors can be clustered at a convenient location on the structure. Redundant connectors can be provided for contingency packer inflation and grouting.



Inflatable Subsea Drilling Riser Seal



Subsea ROV Grouting and Packer Inflation Panel

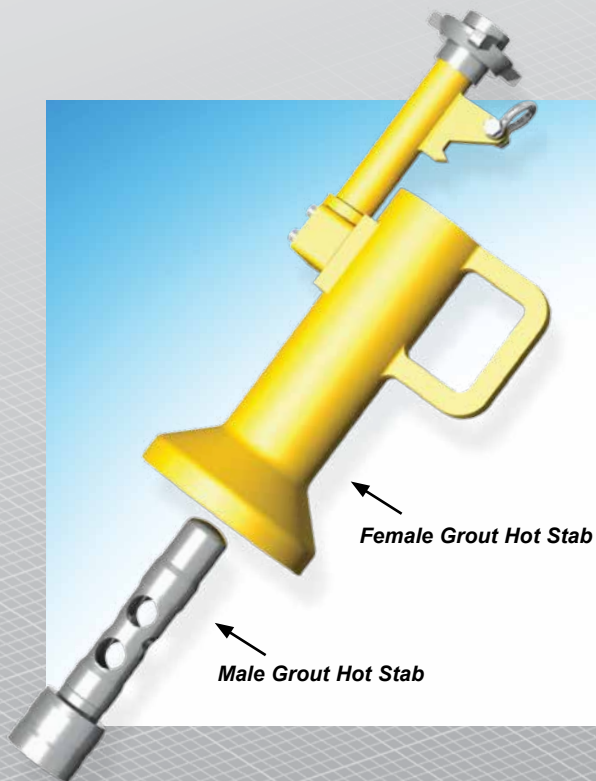

ROV Grouting Advantages

- Minimizes grout piping material and installation costs as compared to surface systems
- Minimizes ROV and vessel movement
- Can be used with any work-class ROV
- Confines grout lines to the pile sleeves
- Eliminates a grout packer inflation line to surface



Fixed Platform Installation

Hydra-Lok™ Pile Swaging

Hydra-Lok™ Pile-Swaging uses hydraulic force to form immediate full-strength structural connections between structure pile sleeves and foundation piles. Because of its simplicity, extreme depth capability, reliability and speed, this technique is ideal for securing subsea manifolds, seafloor templates and platform jackets with skirt piles. The Hydra-Lok™ tool works at any depth and requires no diver intervention or special handling methods.

Hydra-Lok™ Advantages

- Fast, verifiable connections in less than an hour, with immediate full strength
- Compact connections mean pile sleeves and piles can often be shortened significantly, reducing structure weight and cost
- Works with Latch-Lok leveling, allowing a structure corner to be raised to level and locked to the foundation pile in a single tool deployment
- Available for all common pile diameters up to 84 inches

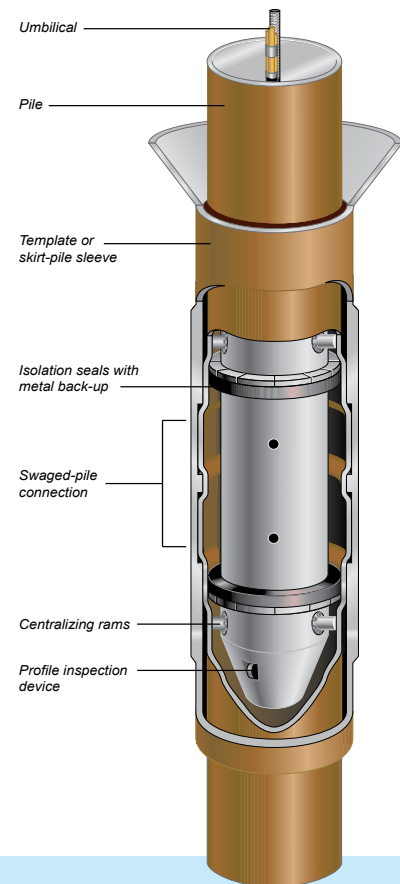

How Hydra-Lok™ connections are formed

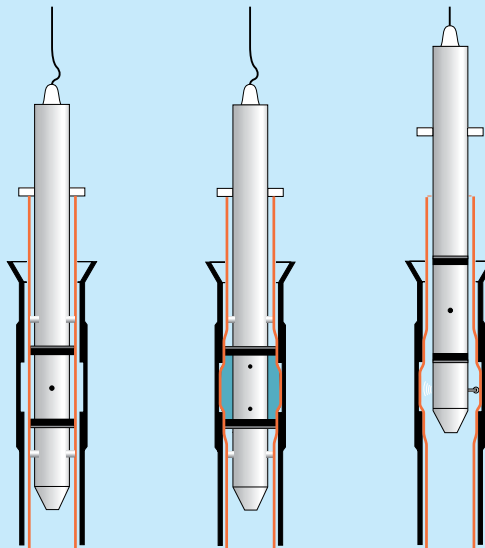

- 1 The Hydra-Lok™ tool is positioned inside the pile, opposite grooves in the pile sleeve.
- 2 With centralizing rams and isolation seals actuated, hydraulic pressure expands the pile into the grooves.
- 3 Connection is complete. An inspection system within the tool confirms connection geometry as the Hydra-Lok™ tool is retrieved.

P/V plot

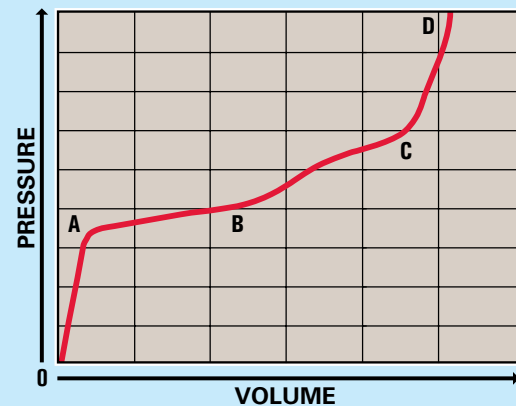

Hydra-Lok™ operators are guided by the above real-time plot, which depicts each phase of connection formation.

- 0-A Elastic expansion of pile.
- A-B Overall plastic expansion of pile between seals.
- B Pile contacts sleeve at groove corner radii.
- B-C Pressure increases as pile bends into grooves.
- C Pile contacts bottom of groove.
- C-D Pressure increase due to elastic restraint of sleeve on pile expansion. The connection is complete.

Jacket Leveling Systems

Oil States provides economical, standardized leveling systems for offshore structures anchored by foundation piles, including subsea templates, subsea manifolds, and platform jackets. During installation and after piles are driven, the structure can be leveled with precision to prevent misalignment of casing hangers and tie-back systems and other problems created by an out of level structure. Oil States Leveling Systems are applicable to all types and sizes of templates and to jackets with either skirt or main piles.

- Incorporated at the structure design stage, the system saves time, effort and risk during the leveling operation
- Deployed and operated from the installation vessel; no diver intervention or guidelines are required
- Straightforward, robust tool design and construction ensure reliable and durable performance
- Back-up tools can be furnished, and redundancy can be built into components as required
- Oil States can prepare economic and operational analyses for your project on request



The Latch-Lok™ Leveling Tool

The Oil States Latch-Lok™ Leveling Tool is a hydraulically actuated lifting device deployed after foundation piles have been driven. The tool is primarily used for leveling templates and jackets with skirt piles, although it can also be used at the surface on a jacket with main piles.

The Latch-Lok™ tool works at any water depth, and it can be used with conventional grouting or in combination with our Hydra-Lok™ pile-swaging system.

The Latch-Lok™ tool is deployed from the installation vessel onto the foundation pile at the lowest corner of the structure. The tool can be adjusted to accommodate various piling heights. No diver intervention or guidelines are required.

Oil States Latch-Lok™ Leveling Tools are available for multiple pile sizes and lift capacities.

- 30 - 42 inch pile sizes, 500 ton load rating
- 48 - 60 inch pile sizes, 500 ton load rating
- 60 - 84 inch pile sizes, 1,750 ton load rating
- 84 inch pile size, 3,000 ton load rating
- 84 – 96 inch pile sizes, 1,750 ton load rating
- 96 - 108 inch pile sizes, 3,000 ton load rating



84" X 1750 ton Latch-Lok™ Leveling Tool

Temporary Pile Grippers

Temporary Pile Grippers are structure-mounted, pile-gripping devices that hold templates or jackets in the leveled position while the structure-to-pile connections are completed. Both components are compatible with either conventional grouting or Hydra-Lok™ pile-swaged structural connections. Our temporary pile grippers allow you to prevent or remedy problems that can delay jacket installation. These economical, radial-gripping tools are welded into the skirt-pile sleeves during fabrication – no diver intervention is required. They actuate temporarily but securely in a variety of applications.



Pile Catcher and Skirt Pile Gripper Weldments Supplied Turnkey

Type ST (Standard) Grippers use compact, radially mounted hydraulic or pneumatic rams to drive serrated segments inward to secure the pile with a bi-directional grip.

Type CS (Collet Style) Grippers are pneumatically actuated devices that have an inflatable elastomer bladder behind serrated collet fingers.

Type PS (Packer Style) Grippers are economical, pneumatically actuated grippers that use an elastomer packer element to effect a friction grip on the pile.

Type SA (Spring Actuated) Grippers are economical, spring-actuated, "one-way" grippers designed for use on temporary drilling templates.



Why Temporary Pile Grippers?

- **Faster structural leveling** – easy to use until sleeve-to-piling connections are complete
- **Storm security** – total time required to secure a jacket is approximately 10 minutes
- **Improved grouting results** – ensuring stability while grout cures and prevent grout shear-bond reduction



Fixed Platform Installation

Pile Handling Systems

Our radial-gripping pile handling tools are the safest, most efficient way to lift, move and position large-diameter pilings for offshore platforms, conductor pipe for oil and gas wells, and other large-diameter tubulars. The remote-operated tools use a powerful radial-gripping action to hold heavy pipe sections securely, without costly and clumsy attachments. All our handling tools have radial-gripping segments that hold pipe around its full circumference, without deforming or damaging the tubular.

The Hydraulic-Actuated Internal Lift Tool stabs into pipe sections for pick-up and lay-down and for moving or holding in a vertical position.

The External Gripper, which can be either hydraulic or pneumatic, is a stationary device that grips pipe strings from the outside while sections are added or removed. Our standard tools are each designed to handle a specific range of pipe sizes. Easy size adjustments can be made by adding or removing standard spacers on the gripping segments. Standard spacers can also be machined in any shop to suit non-standard pipe diameters.



Custom designed motion- compensated ILT for small diameter casing applications

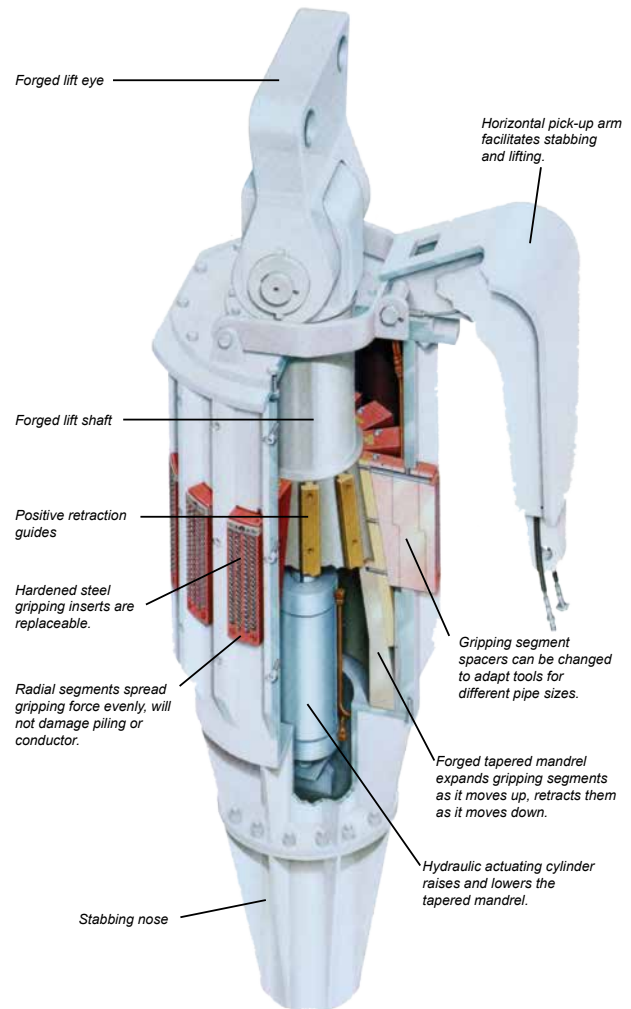

- **Lift, move and position** pilings and conductors without awkward rigging, weld-on lift eyes, weld-on stops or safety clamps.
- **Opposed-wedge tool design** is fail-safe and weight-energized; an increase in pipe load results in an increase in the radial gripping force and prevents accidental release.
- **Simple, sturdy and durable**, these tools minimize the risk of project downtime caused by tool failure.

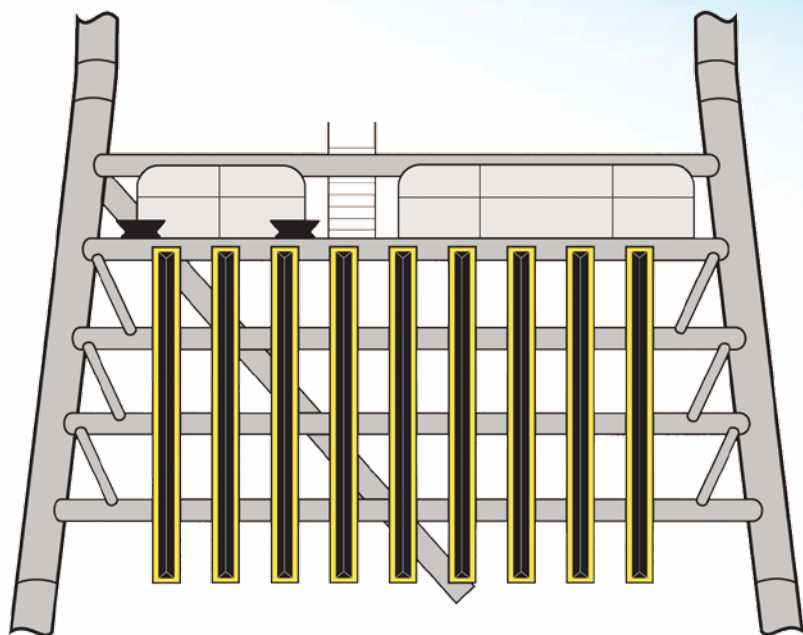

Platform Rub Strips



Photo shows Platform Rub Strips and the Defender Platform Protection System

Platform Fendering Systems

Oil States offers proven elastomeric fendering solutions that minimize structural damage caused by impact from offshore vessels. Our fendering components include:

- **Shock Cells** – tubular bushing mount-loaded along the longitudinal axis
- **Eccentric Bumper Rings** – spring-mass damper system found at the top and bottom of the fender face, typically deployed with a Load Cell assembly
- **Rub Strips** – our natural rubber Load Cells and D-Bumpers offer excellent impact strength, resilience, tensile strength, abrasion resistance, and flexibility at low temperatures

Our natural rubber Load Cells and D-Bumpers offer excellent impact strength, resilience, tensile strength, abrasion resistance, and flexibility at low temperatures.

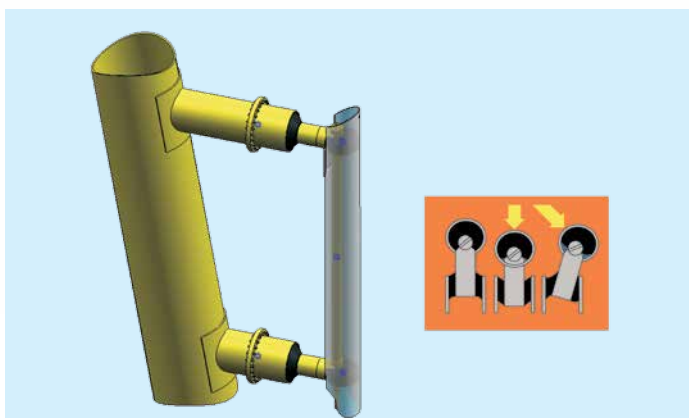

Efficient and economical, Regal Platform Protection Systems use engineered rubber to absorb impact loads.

- **Extremely Durable**
- **Easy to Install**
- **Virtually Maintenance-free**

Oil States Industries has been providing products, services and support to the offshore industry for more than 65 years. Products range from simple grout packers for jacket installation to advanced diverless pipeline equipment and our unrivalled riser FlexJoint™ assemblies. Regardless of function or complexity, you can rely on Oil States to provide the highest quality solution, based on extensive experience backed by world class engineering standards.



Houston Hobby Facility



Houston Ship Channel Facility



FIXED PLATFORM SYSTEMS

OIL STATES INDUSTRIES
Manufacturing, Engineering
& Sales

6120 E. Orem Drive
Houston, Texas 77048 USA
Tel +1 713 445 2210
Fax +1 713 445 2380
Tel +1 985 868 0630

Sales Offices:

Europe & Eurasia

FRANCE
5 Allée des Mésanges
13012 Marseille, France
Tel +33 491 95 60 51

AZERBAIJAN

Vagif Mustafazade Street 6/10
1st Floor, Sahibtat Business Centre
Old City, Baku AZ1010, Azerbaijan
Tel/Fax +994 12 598 1125

Asia & Oceania

SINGAPORE
42-H Penjuru Road
Singapore 609158
Tel +65 6773 7555
Fax +65 6773 7667

MALAYSIA

29-1, Pangapuri Servis
(Suite) Binjai 8 Premium SOHO
Lorong Binjai
Kuala Lumpur, Malaysia 50450
Tel +60 3 2710 7951

AUSTRALIA

Suite 139, Level 1580 Hay Street
Perth WA, 6000
Australia
Tel +61 8 9321 3777

Middle East & Africa

UAE

HDS Tower, Unit 2209, Cluster F
Jumeirah Lakes Towers
Dubai, United Arab Emirates
Tel +971 4 452 8482
Fax +971 4 368 8403

South America

BRAZIL

02 Corporate & Offices
Ed. Evolution III, Bloco 2, Sala 105
Av. Paisagista José Silva de Azevedo
Neto, 200
Barra da Tijuca, RJ Brazil
CEP 22775-056
Tel +55 21 3503 2400

oilstates.com

fixed.platform@oilstates.com