

# **UNIFIED FACILITIES CRITERIA (UFC)**

---

## **MAINTENANCE AND OPERATION: MAINTENANCE OF WATERFRONT FACILITIES**



## UNIFIED FACILITIES CRITERIA (UFC)

### MAINTENANCE AND OPERATION: MAINTENANCE OF WATERFRONT FACILITIES

Any copyrighted material included in this UFC is identified at its point of use. Use of the copyrighted material apart from this UFC must have the permission of the copyright holder.

U.S. ARMY CORPS OF ENGINEERS

NAVAL FACILITIES ENGINEERING COMMAND (Preparing Activity)

AIR FORCE CIVIL ENGINEER SUPPORT AGENCY

Record of Changes (changes are indicated by \1\ ... /1/)

Change No.	Date	Location
1	1 Sept 2012	<u>Various updates and editorial changes throughout.</u>

## FOREWORD

The Unified Facilities Criteria (UFC) system is prescribed by MIL-STD 3007 and provides planning, design, construction, sustainment, restoration, and modernization criteria, and applies to the Military Departments, the Defense Agencies, and the DoD Field Activities in accordance with [USD \(AT&L\) Memorandum](#) dated 29 May 2002. UFC will be used for all DoD projects and work for other customers where appropriate. All construction outside of the United States is also governed by Status of Forces Agreements (SOFA), Host Nation Funded Construction Agreements (HNFA), and in some instances, Bilateral Infrastructure Agreements (BIA.) Therefore, the acquisition team must ensure compliance with the most stringent of the UFC, the SOFA, the HNFA, and the BIA, as applicable.

UFC are living documents and will be periodically reviewed, updated, and made available to users as part of the Services' responsibility for providing technical criteria for military construction. Headquarters, U.S. Army Corps of Engineers (HQUSACE), Naval Facilities Engineering Command (NAVFAC), and Air Force Center for Engineering and the Environment (AFCEE) are responsible for administration of the UFC system. Defense agencies should contact the preparing service for document interpretation and improvements. Technical content of UFC is the responsibility of the cognizant DoD working group. Recommended changes with supporting rationale should be sent to the respective service proponent office by the following electronic form: [Criteria Change Request](#). The form is also accessible from the Internet sites listed below.

UFC are effective upon issuance and are distributed only in electronic media from the following source:

- Whole Building Design Guide web site <http://dod.wbdg.org/>.

Hard copies of UFC printed from electronic media should be checked against the current electronic version prior to use to ensure that they are current.

### AUTHORIZED BY:

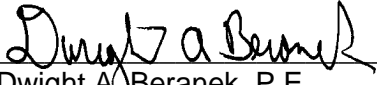
  
Dwight A. Beranek, P.E.  
Chief, Engineering and Construction Division  
U.S. Army Corps of Engineers

  
Dr. Ger Moy, P.E.  
Chief Engineer and  
Director of Planning and Engineering,  
Naval Facilities Engineering Command

  
Michael Aimone, P.E.  
Deputy Civil Engineer  
Deputy Chief of Staff, Installations & Logistics  
Department of the Air Force

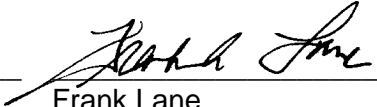
  
Frank Lane  
Director of Analysis & Investment  
Deputy Under Secretary of Defense  
for Installations  
Department of Defense

UFC 4-150-07  
19 June 2001  
Change 1, 1 September 2012

*This page intentionally left blank.*

## TABLE OF CONTENTS

			<u>Page</u>
CHAPTER 1 INTRODUCTION			
Paragraph	1-1	SCOPE.....	1
	1-2	PURPOSE.....	1
	1-3	APPLICATION.....	1
	1-4	TECHNICAL SECTIONS.....	2
CHAPTER 2 MAINTENANCE PLANNING AND TYPES OF FACILITIES			
Paragraph	2-1	MAINTENANCE PLANNING .....	3
	2-1.1	Cooperation and Coordination .....	3
	2-1.2	Joint Service Responsibility .....	3
	2-1.3	Maintenance Standards and Criteria .....	5
	2-1.4	Maintenance Program .....	5
	2-2	TYPED OF FACILITIES.....	6
	2-2.1	Berthing Facilities .....	.7
	2-2.2	Piers .....	7
	2-2.3	Wharves and Quaywalls .....	9
	2-2.4	Drydocking Facilities.....	9
	2-2.5	Coastal Protection Structures .....	12
	2-3	COMPONENTS OF WATERFRONT STRUCTURES.....	15
	2-3.1	Fender Systems .....	16
	2-3.2	Piling .....	17
	2-3.3	Dolphins .....	17
	2-3.4	Fleet Mooring .....	17
	2-3.5	Deck and Mooring Hardware .....	17
	2-3.6	Utility Distribution Systems .....	17
CHAPTER 3 MATERIALS AND PREVENTIVE MAINTENANCE			
Paragraph	3-1	GENERAL .....	19
	3.2	WOOD AND TIMBER.....	20
	3.2.1	Maintenance.....	20
	3.2.2	Wood Deterioration.....	21
	3-2.3	Preventive Maintenance for Wood and Timber .....	25
	3-3	CONCRETE .....	31
	3-3.1	Deterioration.....	32
	3-3.2	Components of Concrete.....	32
	3-3.3	Reinforcing Steel .....	34
	3-3.4	Special Types of Concrete Mixtures .....	34
	3-3.5	Causes of Concrete Deterioration.....	34
	3-3.6	Preventive Maintenance for Concrete.....	35
	3-4	STEEL.....	37
	3-4.1	Steel for Waterfront Construction.....	38
	3-4.2	Deterioration of Steel.....	39
	3-4.3	Preventive Maintenance for Steel .....	40
	3-5	NONFERROUS METALS AND ALLOYS.....	42

3-5.1	Aluminum .....	42
3-5.2	Copper .....	43
3-5.3	Nickel .....	43
3-5.4	Deterioration of Nonferrous Metals and Alloys .....	43
3-5.5	Preventive Maintenance for Nonferrous Metals and Alloys .....	43
3-6	SYNTHETIC MATERIALS .....	44
3-6.1	Fiber-Reinforced Plastics (FRP) .....	45
3-6.2	Plastic and Fiberglass Piles .....	45
3-6.3	Foams .....	46
3-6.4	Rubber and Elastomers .....	46
3-6.5	Other Synthetic Materials .....	46
3-7	SOIL FILL FOR QUAYWALLS AND MOLES .....	47
3-7.1	Description .....	47

**CHAPTER 4 SAFETY AND ENVIRONMENTAL COMPLIANCE**

Paragraph	4-1	INTRODUCTION .....	49
	4-2	OCCUPATIONAL SAFETY .....	50
	4-3	ENVIRONMENTAL COMPLIANCE .....	52
	4-3.1	Environmental Regulations .....	52
	4-3.2	Environmental Documentation .....	55
	4-3.3	Working in Compliance .....	58
	4-3.4	Environmental Training .....	58
	4-3.5	Treated Wood – Environmental Issues .....	59

**CHAPTER 5 INSPECTION**

Paragraph	5-1	GENERAL CONSIDERATIONS .....	61
	5-1.1	Inspection Objectives .....	61
	5-1.2	Information an Inspection Should Provide .....	62
	5-2	LEVELS OF INSPECTION .....	62
	5-2.1	Level I – General Visual Inspection .....	62
	5-2.2	Level II – Close-Up Visual Inspection .....	62
	5-2.3	Level III – Highly Detailed Inspection .....	63
	5-3	PLANNING FOR INSPECTION .....	63
	5-3.1	Inspection Frequency .....	66
	5-3.2	Inspectors .....	68
	5-3.3	Collecting Inspection Plan Data .....	68
	5-3.4	Equipment and Tools .....	69
	5-3.5	Preparing Inspection Documentation .....	70
	5-4	INSPECTION OF TIMBER STRUCTURES .....	75
	5-4.1	Scoping the Problem .....	75
	5-4.2	Surface Inspections .....	75
	5-4.3	Underwater Inspection .....	80
	5-5	INSPECTION OF CONCRETE STRUCTURES .....	84
	5-5.1	Scoping the Problem .....	84
	5-5.2	Surface Inspections .....	84
	5-5.3	Underwater Inspection .....	89
	5-5.4	Level III Test Procedures for Concrete Inspection .....	89

5-6	INSPECTION OF STEEL STRUCTURES .....	91
5-6.1	Scoping the Problem .....	91
5-6.2	Surface Inspections .....	91
5-6.3	Underwater Inspections .....	92
5-7	INSPECTION OF SYNTHETIC MATERIALS AND COMPONENTS	97
5-7.1	Structural Members .....	97
5-7.2	Coatings, Patches and Jackets.....	97
5-7.3	Foam-Filled Fenders .....	97
5-8	INSPECTION OF QUAYWALLS.....	98
5-9	INSPECTION REPORT.....	99

**CHAPTER 6 REPAIR OF WOOD AND TIMBER STRUCTURES**

Paragraph	6-1	GENERAL .....	103
	6-1.1	Repair Methods .....	103
	6-2	REFERENCES .....	104
	6-3	PLANNING THE REPAIRS .....	104
	6-3.1	Reviewing Inspection Reports .....	104
	6-3.2	Engineering Considerations.....	104
	6-3.3	Special Skill Requirements .....	104
	6-3.4	Equipment Requirements .....	105
	6-4	REPAIR PROCEDURES .....	105
	6-5	ENVIRONMENTAL CONCERNS .....	106
	6-6	QUALITY ASSURANCE CONCERNS.....	107

**CHAPTER 7 REPAIR OF CONCRETE STRUCTURES**

Paragraph	7-1	CONCRETE FOR REPAIRS .....	133
	7-1.1	Portland Cement Concrete .....	133
	7-1.2	Special Types of Repair Concrete .....	136
	7-2	PLANNING THE REPAIRS .....	138
	7-2.1	Seismic Impact of Repairs.....	138
	7-2.2	Special Skill Requirements .....	138
	7-2.3	Special Equipment Requirements.....	139
	7-3	METHODS OF PLACING CONCRETE AND MORTARS .....	139
	7-4	CONCRETE REPAIR PROCEDURES .....	153

**CHAPTER 8 REPAIR OF STEEL STRUCTURES**

Paragraph	8-1	GENERAL .....	173
	8-2	PLANNING THE REPAIRS .....	174
	8-2.1	Special Skill Requirements .....	174
	8-2.2	Equipment Requirements .....	174
	8-3	REPAIR PROCEDURES.....	175

**CHAPTER 9 REPAIR OF SYNTHETIC STRUCTURES**

Paragraph	9-1	GENERAL .....	199
	9-2	ISPECTION OF SYNTHETIC MATERIALS .....	199

CHAPTER 10 REPAIR OF BULKHEADS AND QUAYWALLS

Paragraph	10-1	GENERAL .....	207
	10-2	PLANNING THE REPAIRS .....	207
	10-3	REPAIR PROCEDURES OF EARTH-FILLED STRUCTURES .....	208
	10-3.1	Problem .....	208
	10-3.2	Description of Repair/maintenance .....	208
	10-3.3	Future Inspection Requirements .....	211
APPENDIX A		REFERENCES .....	213

**FIGURES**

<u>Figure</u>	<u>Title</u>	
2-1	Single-Deck, open Pier .....	8
2-2	Double-Deck, Open Pier .....	8
2-3	Solid-Fill Pier .....	9
2-4	Floating Pier Design Concept.....	9
2-5	Drydocking Facilities .....	10
2-6	Seawall Configurations .....	13
2-7	Groin .....	14
2-8	Typical Location of Jetties .....	15
2-9	Breakwater .....	16
3-1	Three Groups of Marine Borers.....	23
3-2	Fumigant Vials for Timber Piles .....	28
3-3	Pile Top Bonnet for Timber Piles.....	29
3-4	Timber Pile Jacket for Ice Protection.....	31
4-1	Safety Plan Format .....	51
4-2	Environmental Documentation Process .....	54
5-1	Exposure Zones on Piling .....	67
5-2	Tools and Equipment Used for Waterfront Inspection .....	71
5-3	Standard Pile Inspection Report Form .....	72
5-4	Pile condition Ratings for Concrete Piles .....	73
5-5	Pile Condition Ratings for Timber Piles.....	74
5-6	Damage Areas Involving Timber Members .....	76
5-7	Damage to Timber Piles from Biological Sources .....	77
5-8	Damage to Timber Piles from Non-Biological Sources .....	78
5-9	Damage to Timber Sheet Piling .....	79
5-10	Timber Structures and Attachments (Above Water) Checklist .....	82
5-11	Timber Structures and Attachments (Below Water) Checklist.....	83
5-12	Concrete Structures and Attachments (Above Water) Checklist.....	86
5-13	Inspection Areas for Visual Indications of Concrete and Reinforcement Deterioration.....	87
5-14	Typical Damage to Concrete Piles form Non-Biological Sources.....	88
5-15	Concrete Structures and Attachments (Below Water) Checklist .....	90



5-16	Inspection of Steel Structures (Above Water) Checklist.....	93
5-17	Corrosion Damage to Steel Bearing and Sheet Piling.....	94
5-18	Damage to Steel Bearing and Sheet Piles from Overloading, Wall Movement or Scour.....	95
5-19	Underwater Steel Structures Checklist.....	96
5-20	Quaywall Surface and Underwater Inspection Checklist.....	99
6-1	Repairs to Timber Pier Structure.....	110
6-2	Repair by Replacing Timber Fender Pile and Damaged Chocks and Wales .....	112
6-3	Wrapping Timber Piles with Polyvinyl Chloride .....	114
6-4	Posting Timber Pile with Pile Butt and Fish Plates.....	116
6-5	Concrete Encasement Repairs to Timber Pile .....	118
6-6	Repair by Oriented Fiber Wraps.....	120
6-7	Replacing Damaged Pile with a New Timber Pile .....	122
6-8	Replacing a Damaged Timber Pile with a New Concrete Pile under a Concrete Deck .....	124
6-9	Installing or Replacing Tie-Back System for Timber Sheet Piling Wall.....	126
6-10	Installing a Tie-Back system at Top of a Timber Sheet Piling Wall .....	128
6-11	Installing a Concrete Cap and/or Face on a Timber Sheet Piling Wall.....	130
7-1	General Steps to Concrete Repair .....	154
7-2	Typical Crack Repair with Epoxy Grout Injection .....	157
7-3	Joint and Crack Repair.....	160
7-4	Repairs to Concrete Seawalls .....	162
7-5	Miscellaneous Repairs to Concrete Piles.....	164
7-6	Jacketing Concrete Piles.....	166
7-7	Typical Concrete Wall Repair.....	171
8-1	Protecting Steel Piles by Coating or Jacketing.....	178
8-2	Cathodic Protection for Steel Bearing Piles.....	180
8-3	Repair by Partially Replacing the Steel Pile .....	182
8-4	Repair by Steel Pile Using Concrete Encasement .....	184
8-5	Replacing Damaged or Deteriorated Steel Piles .....	186
8-6	Coating/Cathodic Protection of Steel Sheet Pile Wall .....	188
8-7	Repairs to Steel Sheet Pile Walls using Different Patching Methods .....	190
8-8	Installing or Replacing Tieback Systems for Steel Sheet Pile Wall .....	192
8-9	Replacing Existing Steel Sheet Pile Wall with New Steel Sheetpiling or Timber Pile Wall .....	194
8-10	Installing a Concrete Cap and/or Face on a Steel Sheetpiling Wall .....	196
8-11	Scour Protection for Steel Pile Supported Waterfront Structure.....	198
9-1	Typical Caisson Wood Seal Assembly .....	204
9-2	Steel Reinforced All-Rubber Caisson Seal Assembly .....	205

**TABLES**

<u>Table</u>	<u>Title</u>	
3-1	Summary of Preventive Maintenance Actions.....	19
5-1	Capability of Each Level of Inspection for Detecting Damage to Waterfront Structures.....	64
5-2	Production Rate for Surface and Underwater Inspection of Structural Elements .....	65
5-3	Daily Rates for Underwater Inspection Tasks .....	66
5-4	Sampling Equipment, Measurements and Ratings for Timber Structures.	80
5-5	Sampling Equipment, Measurements and Ratings for Concrete Structures .....	85
5-6	Inspection Equipment, Measurements and Ratings of Steel Structures ...	92
5-7	Report Format of Underwater Inspections and Assessments .....	100
6-1	Repair Techniques for Wood and Timber Structures .....	106
7-1	Recommended Mix Proportions .....	137
7-2	Placement of Concrete and Mortar .....	140
7-3	Repair Techniques for Concrete Structures .....	153
8-1	Repair Techniques for Steel Structures .....	176
9-1	Repair Techniques for Synthetic Material .....	199

## CHAPTER 1

### INTRODUCTION

1-1 **SCOPE.** UFC 4-150-07 is a guide for the inspection, maintenance, and repair of waterfront structures and related facilities. It is a source of reference for planning, estimating, and performing technical maintenance and repair work; and may serve as a training manual for waterfront facilities maintenance personnel.

1-2 **PURPOSE.** This document provides guidance for maintenance and repair of waterfront facilities to retain them in continuous readiness for use by the Fleet and in support of military marine operations.

1-3. **APPLICATION.** The types of waterfront facilities covered include:

- Berthing facilities for mooring and for providing support to ships and craft.
- Drydocks used for modification, inspection, maintenance and repair of ships.
- Components of waterfront structures such as piling, dolphins, bulkheads, and decks.

Fender systems are briefly considered. Refer to MO-104.1, *Maintenance of Fender Systems and Camels*, for detailed coverage.

Not specifically considered in this document are:

- Coastal protection structures designed to protect shorelines or harbors.
- Components of waterfront structures such as utility distribution systems and fleet moorings.

The maintenance and repair of coastal protection structures is included in the Army Corps of Engineers, *Shore Protection Manual*, Volumes I and II. Repair of coastal structures is covered in more detail in USACE, *Coastal Engineering Technical Notes and Repair, Evaluation, Maintenance, and Rehabilitation Technical Notes*. The maintenance of utility distribution systems is covered by various service manuals and commercial publications. NAVFAC MO-124, *Mooring Maintenance Manual*, provides details on the maintenance of fleet mooring systems.

These documents, and all Government documents referenced in this document, provide additional guidance primarily to DOD and U.S. Coast Guard activities.

They may also be useful, however, to commercial firms that provide waterfront repair for these activities. \\ /1/

1-4      **TECHNICAL SECTIONS.** The technical sections following this introduction include:

MAINTENANCE PLANNING AND TYPES OF FACILITIES (Chapter 2):

- Joint service responsibilities, maintenance policies, and the basic elements of maintenance planning.
- Overview of waterfront facilities.

MATERIALS AND PREVENTIVE MAINTENANCE (Chapter 3):

- Describes materials at the waterfront and the types of deterioration likely to be encountered.
- Describes preventive maintenance measures for each type of material.

SAFETY AND ENVIRONMENTAL CONSIDERATIONS (Chapter 4):

- Guidelines for personnel and work site safety.
- Guidelines for assuring compliance with environmental policies and regulations.

INSPECTION (Chapter 5):

- Overview of inspection levels, methods, planning, equipment and documentation.
- Guidance and checklists for above and underwater inspection of timber, concrete, steel, synthetics, and rubble-mound structures.

REPAIR (Chapters 6, 7, 8, 9, and 10):

- Describes and illustrates repair methods and techniques for the problems encountered.
- Guidance for selecting material along with pertinent references and standards.

## CHAPTER 2

### MAINTENANCE PLANNING AND TYPES OF FACILITIES

#### 2-1 MAINTENANCE PLANNING

##### 2-1.1 Cooperation and Coordination

2-1.1.1 **Intraservice Functions.** Cooperation and coordination of waterfront maintenance activities among the installation departments concerned should be continuous. Properly planned and executed maintenance programs prevent undesirable interruption of operations on military installations. Supply officers, through normal channels, provide standard items of materials and equipment for waterfront maintenance.

2-1.1.2 **Interservice and Interdepartmental Functions.** Cooperation and coordination in conducting waterfront maintenance are encouraged at all levels of command. Appropriate liaison should be established and maintained between major commands and installations in a geographical area. Cross-service assistance should be provided as necessary in the interests of economy and maximum utilization of manpower and equipment. Technology transfer of improved maintenance methods and materials should be continuously encouraged.

2-1.1.3 **Fleet Requirements.** All maintenance and repair activities should be scheduled and coordinated to minimize pier down time for the fleet. Direct communication with the fleet command is vital for ensuring fleet requirements are considered when planning pier maintenance or repair.

2-1.2 **Joint Service Responsibility.** The responsibility for inspection, maintenance, and repair of waterfront structures and related facilities rests with each service. Because of the quantity of waterfront facilities in inventory, the Navy retains a strong technology base in design, construction, and maintenance of waterfront structures: such as piers, wharves, quaywalls, dry-docks, dolphin assemblies, and moorings. The Army maintains a similar capability for coastal harbor facilities, such as breakwaters, jetties, groins, and seawalls.

2-1.2.1 **Army.** Staff, command, and technical responsibility for maintenance and repair of waterfront structures at Army installations will conform to assignments set forth in AR 415 and 420-10 series. Policy and standards for the maintenance of shore protection works are contained in ER-1110-2-2902, *Prescribed Procedures for the Maintenance and Operation of Shore Protection Works*.

U.S. Army Engineer divisions and districts provide specialized expertise in evaluation of coastal erosion, and design and maintenance of coastal and harbor facilities.

\1\ /1/2-1.2.2 **Navy.** The Naval Facilities Engineering Command (NAVFAC), \1\ is /1/ responsible for organizing and performing waterfront inspection, maintenance, repair, and minor construction programs to support the Commanding Officer at each Naval shore installation. NAVFAC MO-322, *Inspection of Shore Facilities*, (Volumes 1 and 2) contains Navy guidelines for shore facilities inspection and preventive maintenance programs.

\1\ NAVFAC provides design, maintenance, and repair management expertise to assist the shore activities in carrying out their mission of maintaining waterfront facilities. Requests for assistance should be directed to the appropriate local NAVFAC office. /1/

Specialized expertise in waterfront materials, structures, and related topics can be provided to DOD and other Federal activities by the Naval Facilities Engineering Service Center (NFESC), Port Hueneme, California. Current criteria documents for maintenance and repair of waterfront facilities are developed and maintained by \1\ NAVFAC LANT C11. /1/

The Navy's underwater construction teams (UCT) provide military responsive capability for construction, installation, inspection, repair, and removal of ocean facilities. \1\ NTRP 4-04.2.8, *Conventional Underwater Construction and Repair Techniques* and NTRP 4-04.2.9, *Expedient Underwater Construction and Repair Techniques*, provide guidelines /1/ for UCT teams in underwater inspection and repair techniques that may be useful to facilities maintenance personnel. UCT ONE is located in Norfolk, Virginia; UCT TWO is located in Port Hueneme, California.

2-1.2.3 **Air Force.** Policy and standards for the maintenance, repair, and minor construction of Air Force facilities are set forth in Air Force Instruction \1\ 32-1023, *Design and Constructing Military Construction Projects*. /1/

The installation commander, assisted by the Base Civil Engineer (BCE) and others on the staff, is responsible for identifying, planning, and programming all real property maintenance, repair, and minor construction requirements necessary to properly support assigned missions and people (including tenants) and to care for and preserve Air Force real property. Major commands provide oversight to ensure compliance with law, Department of Defense (DOD) and Air Force policies and are responsible for establishing quality standards. The Civil Engineer, HQ USAF/ILE provides programming guidance, oversight, and policy as required. The Air Force Civil Engineer Support Agency (AFCESA) and Air Force Center for Environmental Excellence (AFCEE) provide technical engineering guidance.

### 2-1.3 Maintenance Standards and Criteria.

2-1.3.1 **Engineering.** The need for and accomplishment of major repairs and rehabilitation of existing waterfront facilities will be based on experience, judgment, and engineering evaluation. The services of qualified technical personnel will be used to assist in the establishment of waterfront maintenance programs.

2-1.3.2 **Related Published Material.** Navy requirements for the design and construction of waterfront facilities are found in UFC 4-152-01, *Design: Piers and Wharves* and UFC 4-151-10, *General Criteria for Waterfront Construction*. These documents provide guidance and recommendations on port design and construction and port maintenance primarily for Navy activities. MO-322, NTRP 4-04.2.8, and NTRP 4-04.2.9 /1/ are especially important relative to inspection of waterfront structures. Maintenance of fendering systems and camels are described in MO-104.1. Reference to other published materials, which provide related or more extensive information on specific areas of waterfront maintenance, is made where appropriate throughout this handbook. A Glossary of waterfront terms is provided in this handbook.

2-1.4 **Maintenance Program.** The maintenance program shall be designed to include prevention of deterioration and damage, prompt detection of deficiencies, and early accomplishment of maintenance and repairs to prevent interruptions to operations or limiting full use of a facility. The Navy's principal guide for maintenance management is NAVFAC MO-321, *Facilities Management*.

2-1.4.1 **Planning and Economic Considerations.** In maintenance planning and execution, consider future expected use of each facility, the life expectancy of the facility, and the life cycle cost of periodic repairs versus replacing a facility or major components. The level of maintenance and programming of major repairs should be planned in consonance with the future requirement for the facility and planned replacement. When waterfront structures are in an inactive status, the maintenance policies will be in accordance with the inactivation plan.

2-1.4.2 **Inspection.** Periodic, rigorous inspections are necessary for an effective maintenance program. Types of inspections and detailed procedures for waterfront facilities are described in Chapter 5.

2-1.4.3 **Maintenance.** Maintenance is the recurrent day-to-day, periodic, or scheduled work that is required for a facility to be used for its designed purpose. It includes routine work undertaken to prevent damage or deterioration of a facility that otherwise would be more costly to restore. The more common concerns in maintenance of waterfront facilities are:

- Painting and protective coating.

- Routine replacement or mending of fender components (e.g., rub strips) to prevent damage to ships and the pier.
- Maintenance of utility systems to prevent outages.
- Routine mending of protective plastic wraps.
- Routine patching of small concrete spalls and cracks.
- Maintenance of the cathodic protection system.

Chapter 3 provides details of maintenance procedures in addition to descriptions of waterfront materials and deterioration causes.

2-1.4.4 **Repair.** Repair is the restoration of a facility to such a condition that it can be used for its designed purpose. The repair is done by overhaul, reconstruction, or replacement of deteriorated constituent parts or materials that have not been accomplished through maintenance. The more common repair projects for waterfront facilities are:

- Replacement or reconstruction of fender systems.
- Repair of eroded or failing quaywalls.
- Repair and resurfacing of pier decks.
- Reconstruction of major concrete spalls and cracks.

Chapters 6 through 10 provide details of repair options for waterfront structures. These sections are organized to guide engineering and maintenance personnel in selecting repairs to waterfront facilities. Each repair procedure is a stand alone document, with the repair description on the left and the illustration on the right hand page. In Sections 6, 7 and 8, repair procedures are numbered (for example, TR-1; timber repair number one) to permit identification and reference. For many of the repair procedures, problem definition and application constraints are also provided to guide the user in selecting the proper repair technique to match the problem.

2-2 **TYPES OF FACILITIES.** The types of waterfront facilities include:

- Berthing facilities for mooring and for providing support to ships and craft.
- Drydocks used for construction of ships and to expose the underwater portion of the ship for repair, modification, inspection, or maintenance.



- Coastal protection structures designed to protect shorelines or harbors.
- Components of waterfront structures such as fender systems, piling, dolphins, utility distribution systems, deck and mooring hardware, and fleet moorings.

2-2.1 **Berthing Facilities.** The basic facilities to provide berthing support for ships and craft are piers and wharves. These facilities provide a safe space for ships to moor and receive shore utilities and other hotel services. They provide a platform for loading and unloading cargo and personnel, transferring ordnance, receiving fuel, and performing ship maintenance; repair; and fitting out. Berthing facilities are also provided for tugboats, small craft, barges, and harbor support equipment.

2-2.2 **Piers.** Piers are berthing facilities that extend outward from the shore into the water. Piers may be used for berthing on one or both sides of their length. There are three types of pier structures with distinct differences in configuration: open, closed, and floating piers. Combination piers combine open and closed configurations.

Open piers are pile-supported platform structures that allow water to flow underneath. Pile supported piers can be single-deck or double-deck structures. Figures 2-1 and 2-2 show schematics of a single- and double-deck, open piers.

Figure 2-1 Single-Deck, Open Pier

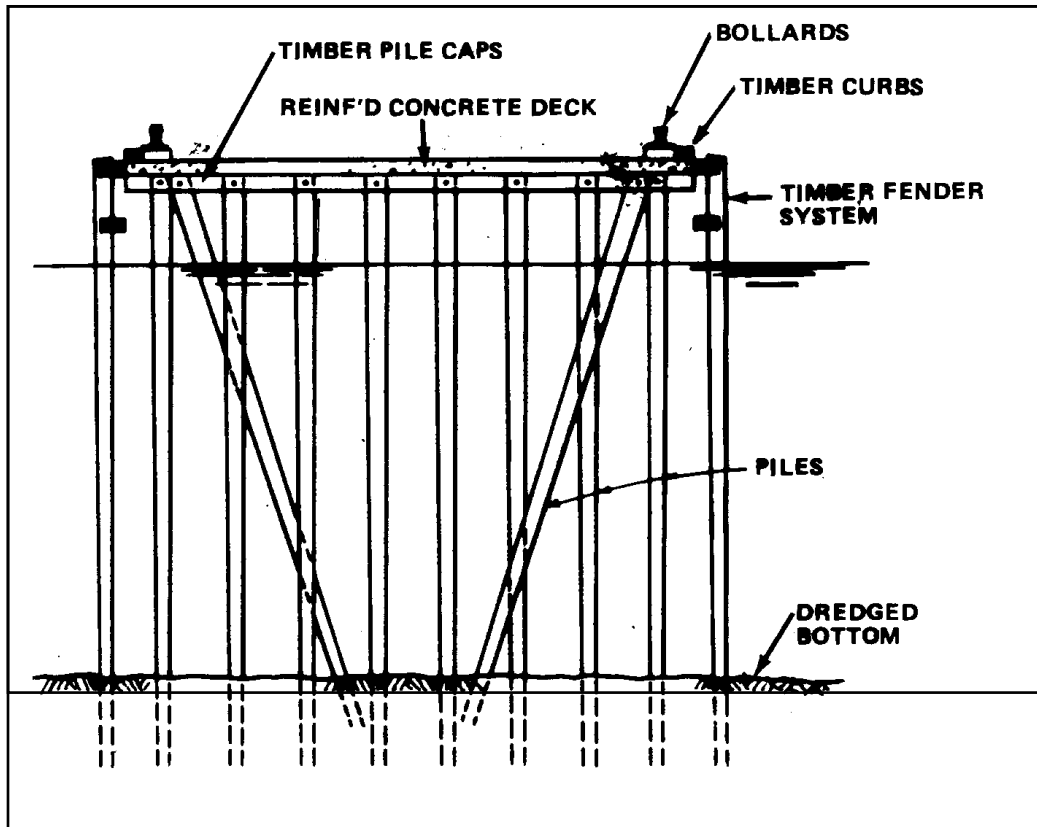
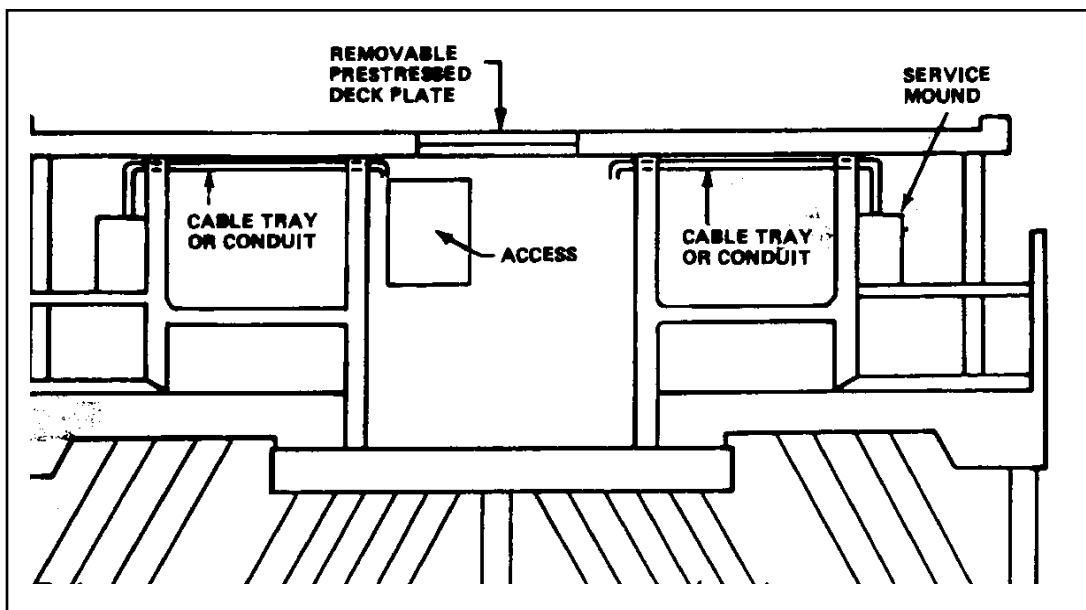

Figure 2-2 Double-Deck, Open Pier



Closed piers, or solid fill piers, are constructed so that water is prevented from flowing underneath. The solid fill pier is surrounded along the perimeter by a bulkhead to hold back fill. Figure 2-3 shows a schematic of a solid fill pier. A special type of solid fill pier is a mole pier. Mole piers are earthen structures that extend outward from the shore. The sides and offshore end of the pier are retained and protected by sheet piles, circular cells or walls of either masonry or concrete. If the water is deep, the pier can be used to berth ships.

Floating piers are constructed of steel or concrete and are connected to the shore with access ramps. Guide piles in the center of the pier, or a chain anchorage system, prevent lateral movement and allow the pier to move up and down with the tide. The floating pier may be a single-deck or a double-deck structure. A floating pier design concept developed by the Navy is shown in Figure 2-4.

A more detailed discussion of the design and configuration of piers is documented in \1\ UFC 4-152-01 /1/, *Design: Piers and Wharves*.

**2-2.3 Wharves and Quaywalls.** Wharves are berthing facilities that are parallel to the shore. They are normally connected to the shore along their full length, and a retaining structure is used to contain earth or stone placed behind the wharf. This retaining structure is often referred to as the quaywall or bulkhead. Ships are moored along the outshore face of the wharf. The wharf types are the same as the basic pier types and include open and closed (or solid fill) configurations. Figure 2-3 shows a solid-fill pier with a configuration similar to a closed wharf.

**2-2.4 Drydocking Facilities.** Navy drydocking facilities are used to expose the underwater portion of ships for repair, modification, inspection, or maintenance. Several different types of drydocks exist, including graving drydocks, floating drydocks, marine railways, and vertical ship lifts.

- Graving drydocks are fixed basins adjacent to the water's edge and are constructed of stone masonry, concrete, or sheet pile cells. They can be closed off from the waterway by a movable watertight barrier (entrance caisson or flap gate). After closing the barrier, the basin is pumped dry, which allows the ship to settle on blocking set on the dock floor. Figure 2-5 shows a schematic of a graving drydock.

Figure 2-3 Solid-Fill Pier

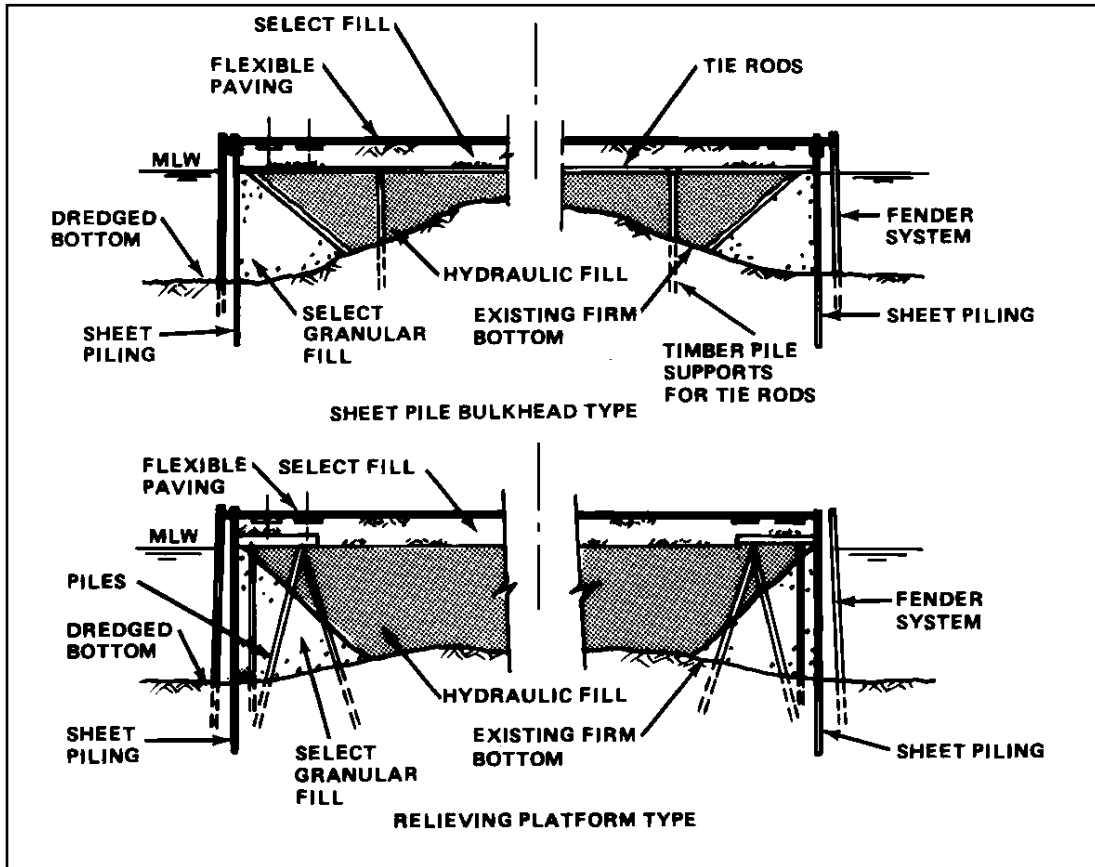

Figure 2-4 Floating Pier Design Concept

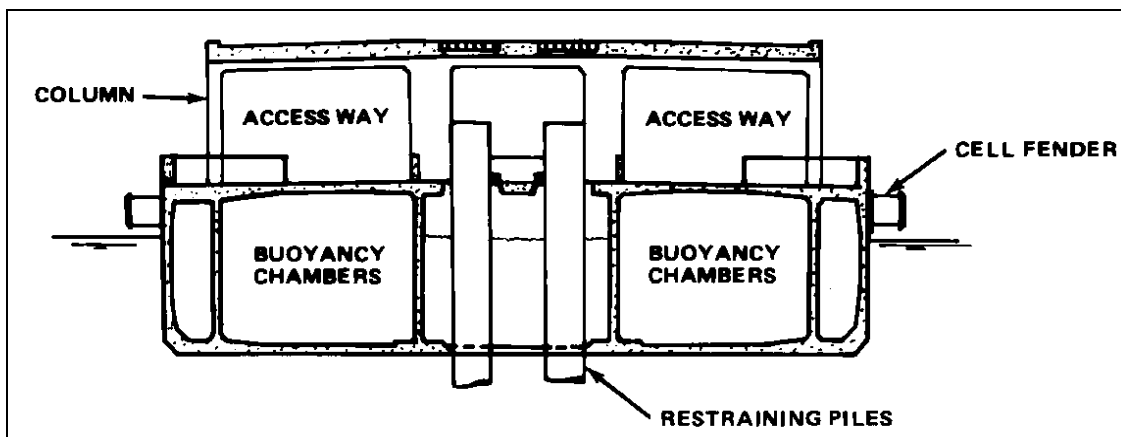
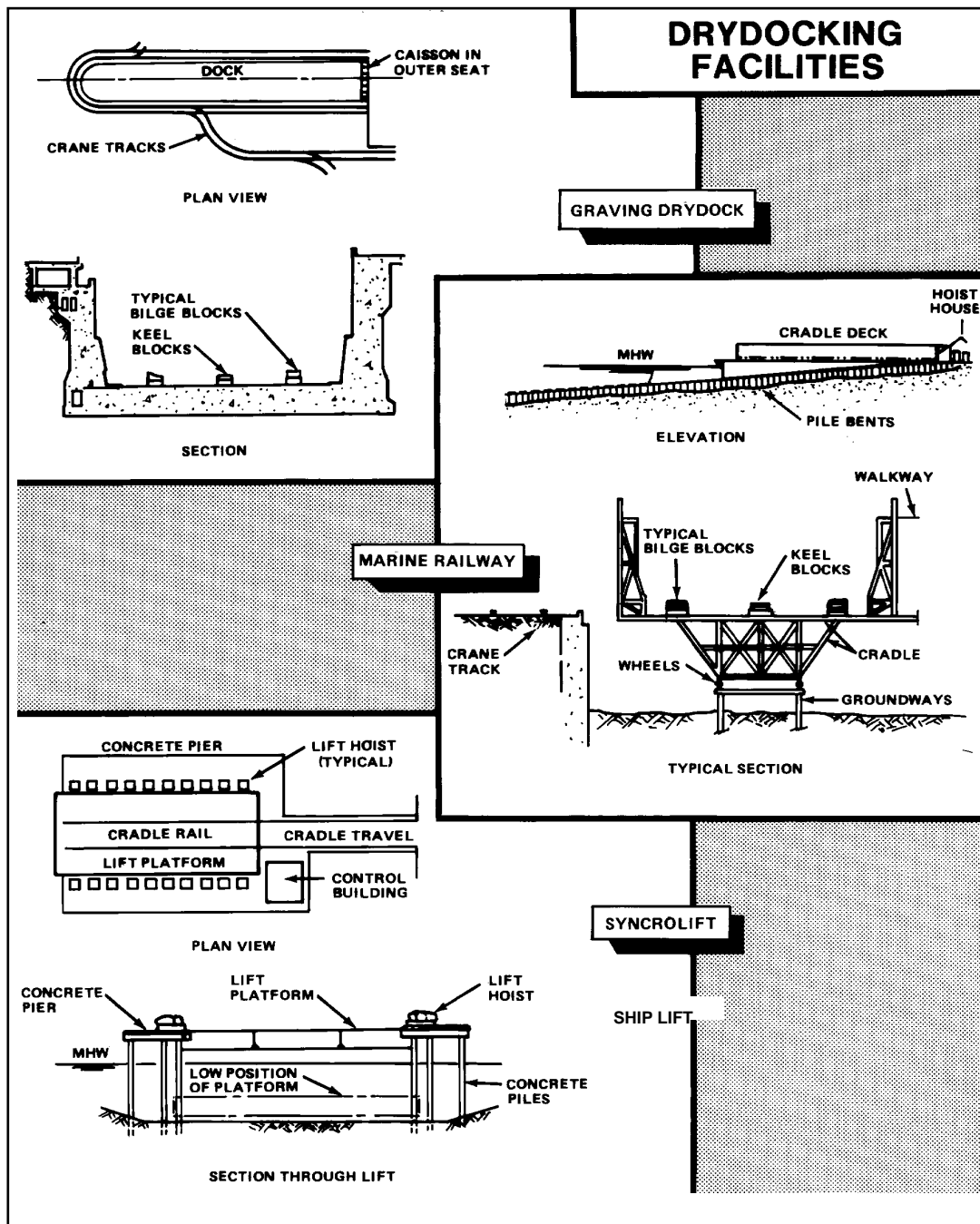

Figure 2-5 Drydocking Facilities



- Floating drydocks are ship or U-shaped structures that are submerged by flooding to permit a vessel to enter and then pumped dry to raise the vessel out of the water.
- Marine railways consist of a ramp extending into the water, a mobile ship cradle on wheels or rollers, groundway ship cradle tracks, hoisting machinery, and chains or cables for hauling the ship cradle endwise or sidewise. Figure 2-5 shows a marine railway.
- Ship lifts consist of platforms that are lowered into the water to receive ships. The ship is then lifted out of the water on the platform by electrical powered hoist equipment. Figure 2-5 shows a vertical ship lift drydocking system.

More detailed discussions of drydocking and marine railway facilities can be found in \1\ UFC 4-213-10, *Design: Graving Drydocks* and UFC 4-213-12, *Drydocking Facilities Characteristics*. /1/ Maintenance of drydocking facilities is not specifically covered in this manual.

**2-2.5 Coastal Protection Structures.** Structures designed to reduce the erosive effects of wave action, or to protect harbors from excessive wave action and the formation of sandbars, are classified as coastal protection structures. The common coastal protection structures are seawalls, groins, jetties, and breakwaters. \1\ The U. S. Army Corps of Engineers, *Shore Protection Manual* provides /1/ additional information on the design and configuration of coastal protection structures. Maintenance of coastal protection structures is not specifically covered in this handbook. Bulkheads are included, however, because they are an integral part of solid fill piers.

**2-2.5.1 Seawalls.** Seawalls are massive coastal structures built along the shoreline to protect coastal areas from erosion caused by waves and flooding during heavy seas. Seawalls are constructed of a variety of materials including rubble-mounds, granite masonry, or reinforced concrete. They are usually supplemented by steel or concrete sheet pile driven into the soil and are strengthened by wales and brace-type piles. Figure 2-6 shows three seawall configurations.

Figure 2-6 Seawall Configurations

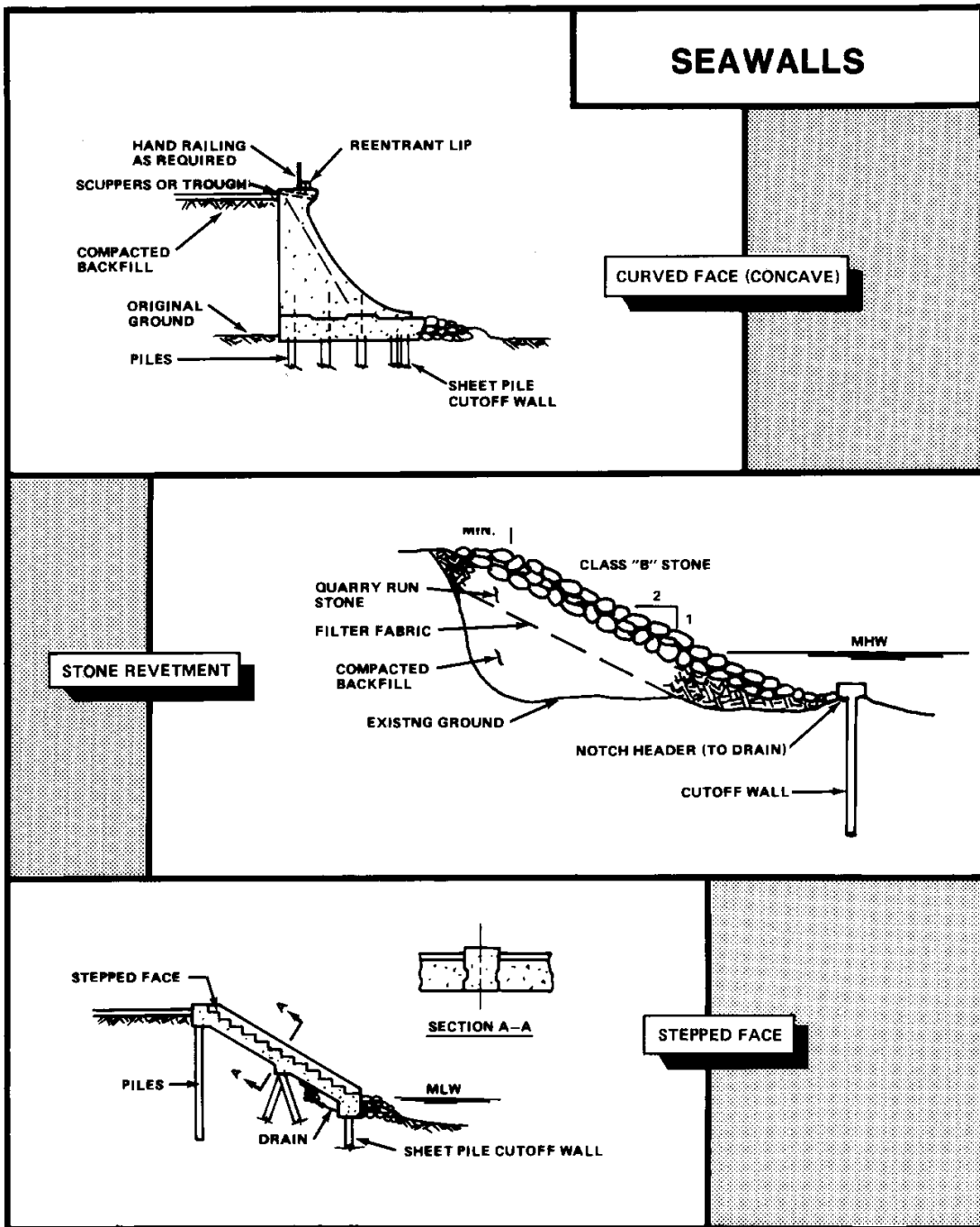

2-2.5.2 **Groins.** Groins are structures designed to control the rate of shifting sand by influencing offshore currents and waves so that erosion of the shoreline is minimized. Groins project outward, perpendicular to the shoreline, and are constructed of large rocks, pre-cast concrete units, reinforced or prestressed concrete piles, steel sheet piles, or timber cribbing filled with rock. Figure 2-7 is an example of a groin.

2-2.5.3 **Jetties.** Jetties are structures that extend from the shore into deeper water to prevent the formation of sandbars and to direct and confine the flow of water due to currents and tides. These structures are normally located at the entrance to a harbor or a river estuary. Jetties are usually constructed of mounds of large rubble about a meter above the high tide mark. Figure 2-8 shows the position of jetties at a harbor entrance.

Figure 2-7 Groin

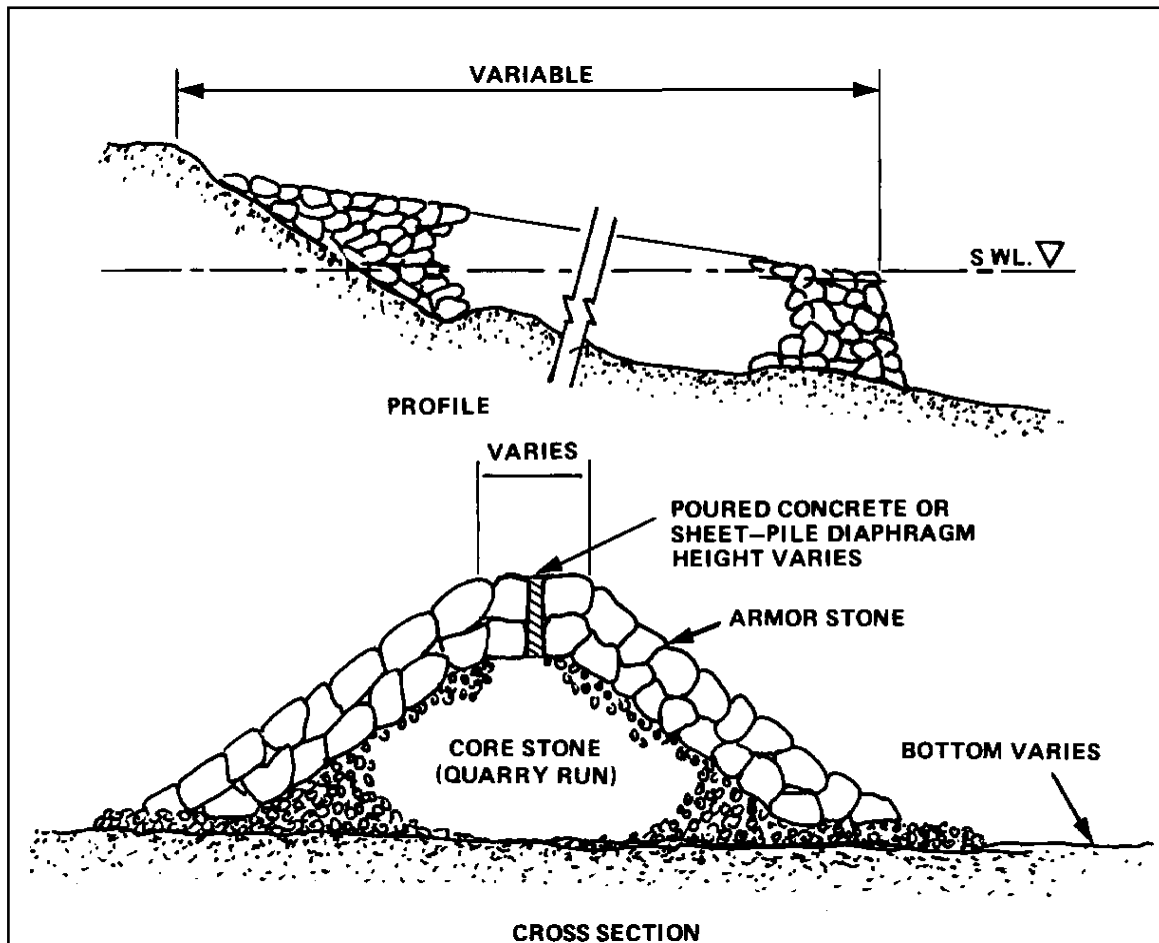
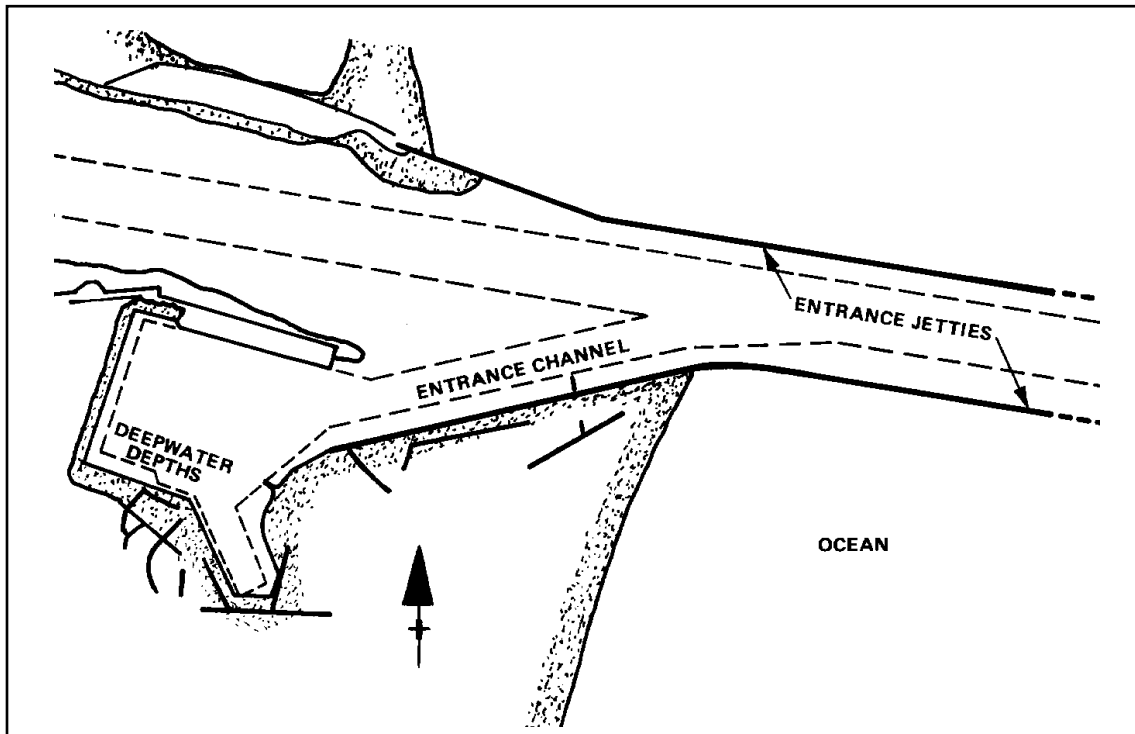



Figure 2-8 Typical Location of Jetties



2-2.5.4 **Breakwaters.** Breakwaters are large rubble-mound structures located outside of a harbor, anchorage, or coastline to protect the inner waters and shoreline from the effects of heavy seas. These barriers help to ensure safe mooring, operating, loading, or unloading of ships within the harbor. Breakwaters may be connected to the shore or detached from the shore. There are three general types of breakwaters, depending on the type of exposed face. The exposed face may be vertical, partly vertical and partly inclined, or inclined. Figure 2-9 shows a section of a breakwater.

2-3 **COMPONENTS OF WATERFRONT STRUCTURES.** Numerous components of basic facilities are present at the waterfront to aid in port operations. These components are integral parts of piers and wharves and include fender systems, piling, dolphins, deck and mooring hardware, and utility distribution systems, or they may be offshore systems vital to ship operations, such as fleet moorings. Utility distribution systems and offshore systems are not specifically covered in this manual.

Figure 2-9 Breakwater Section

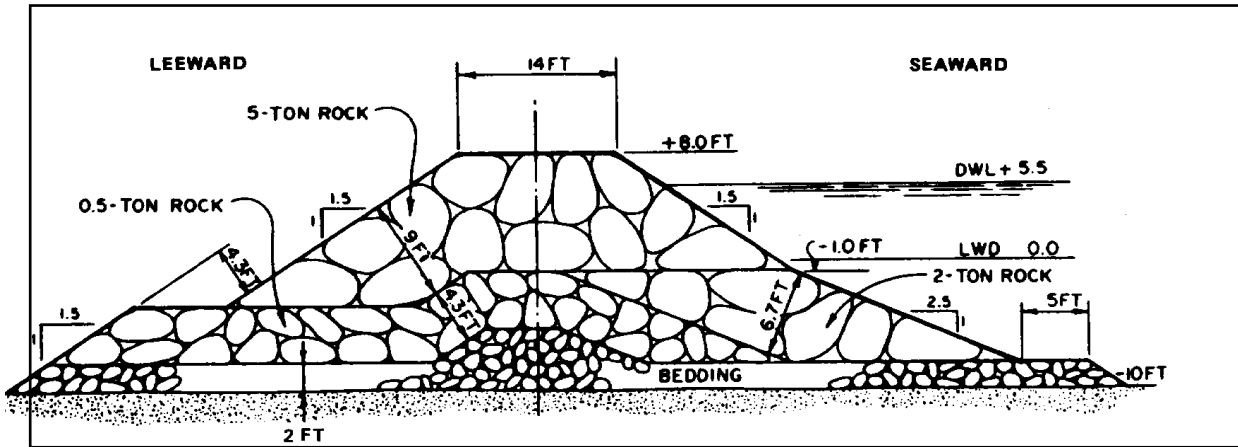

2-3.1 **Fender Systems.** Fender systems are used on piers to protect the ship and the pier during berthing operations and while the ship is moored. The most widely used fender system consists of timber fender piles, timber wales, and chocks, with rubber compression fender units between the system and the pier to absorb berthing impacts. This type of system is the highest maintenance cost portion of the pier. The trend is toward using longer lasting and more resilient fender systems with less reliance on treated timber because of environmental concerns.

The main types of fenders, and their components, that may be found installed in ports are:

- Fender pile systems: timber, steel, concrete, or composite piles.
- Fenders fixed to the pier (“rubber” refers to various elastomeric plastic materials):
  - a. Rubber-in-compression units: cylindrical, rectangular, trapezoidal, wing-type, and D-shaped units.
  - b. Rubber-in-shear fenders: rectangular rubber column and Raykin fender.
  - c. Buckling fender: buckling column fender and cylindrical cell fender.
- Resilient, floating pneumatic and foam-filled fenders connected or suspended from the pier or backed up by closely driven steel or

concrete fender piles. \1\ UFC 4-152-01 /1/ gives more in-depth descriptions of types of fender systems. The maintenance of fender systems is covered in MO-104.1.

2-3.2 **Piling.** Piling is an integral part of all open piers and wharves. The exposure of piling makes it susceptible to severe environmental attack: corrosion, marine borers, and erosion. Piling is made from concrete, wood, steel, or composite materials and requires protective coatings, preservatives, or wraps to ensure a long life.

There are four functional types of piling: vertical bearing piles, batter piles, fender piles, and sheet piles. Bearing piles are used to support the weight of the pier and loads on the pier. Batter piles provide lateral and longitudinal stability. Fender piles are used to absorb the impact of berthing ships. Sheet piling is used for various waterfront structures, e.g., quaywalls to retain fill.

2-3.3 **Dolphins.** A dolphin is a group of piles placed near piers and wharves, or in turning basins and ship channels. These structures are used to guide vessels into their moorings, to mark underwater structures (shoals or shore), and to support navigational aids.

2-3.4 **Fleet Mooring.** A fleet mooring is an offshore anchoring system that consists of various hardware items: chain, cable, sinkers, anchors, and buoys. The offshore anchoring system is placed in a fixed location so that vessels, when entering the port, can anchor to the buoys. NAVFAC MO-124, *Mooring Maintenance Manual* provides details on the maintenance of fleet mooring systems, therefore, they are not covered in this handbook.

2-3.5 **Deck and Mooring Hardware.** Various deck and mooring hardware, such as gratings, handrails, bollards, bits, cleats, chocks and rings, are used on piers and wharves. These items require inspection and maintenance to ensure personnel safety and adequate mooring facilities for ships.

2-3.6 **Utility Distribution Systems.** Utility distribution systems are provided on most piers and wharves to service the ships. Utilities available at most piers and wharves include:

- Steam
- Potable water
- Saltwater
- Sewage and oily waste collection
- Compressed air

- Electricity
- Fuel
- Telephone service
- Fire alarm systems

These utility systems require maintenance of conduit, piping, valves, expansion joints, drains, regulators, and insulation. The maintenance of utility systems and their components is covered by various service manuals and commercial publications, and is not included in this manual.

## CHAPTER 3

### MATERIALS AND PREVENTIVE MAINTENANCE

3-1 **GENERAL.** Common structural materials used for construction and repair in waterfront areas are: wood, reinforced concrete, steel, and plastic. Selecting the proper materials and systems can reduce maintenance costs and increase the life of facilities. Wood preservatives, coatings, quality control of the reinforced concrete materials, cathodic protection, and carefully selecting alloys and synthetic materials help extend the life of the materials and structures.

This Section describes types of materials used in the construction and repair of waterfront facilities; types of deterioration, corrosion, and other problems that may be encountered; and preventive maintenance (PM) actions that should be taken. Table 3-1 summarizes PM actions that should be a part of all waterfront maintenance programs.

**Table 3-1. Summary of Preventive Maintenance Actions**

PREVENTIVE MAINTENANCE ACTION	PARAGRAPH TITLE
<b>Wood and Timber – General</b>	
Use pressure-treated member	Pressure Treatment
Treat exposed areas: cuts, bolt holes, pile tops	Field Treating Exposed Areas of Wood Before Installation
Embed fumigant in pile top	Encasements and Retardants
Use pile top bonnet and preservative	Encasements and Retardants
<b>Timber Piles</b>	
Install plastic wrapping or jacket	Protection of Timber Piles
<b>Concrete - General</b>	
Use Type II or V cement	Cement
Avoid marine aggregates	Aggregates
Provide adequate cover over reinforcing steel	Reinforcing Steel
Use coating on concrete above splash zone	Preventive Maintenance for Concrete
Treat cracks with a flexible elastomeric or with polyurethane injection	Treatment of Cracks
<b>Steel – General</b>	
<b>Design Actions</b>	
Select proper protective coating for immersed steel	Protective Coatings for Steel
Provide cathodic protection system	Cathodic Protection of Steel
Substitute corrosion resistant metals for steel	Nonferrous Metals and Alloys
Increase thickness to allow for corrosion over life cycle	
Minimize galvanic corrosion:	Preventive Maintenance for Nonferrous Metals and Alloys

Minimize use of different metals	Preventive Maintenance for Nonferrous Metals and Alloys
Insulate different metals from each other	Preventive Maintenance for Nonferrous Metals and Alloys
Maintain protective coatings	Preventive Maintenance for Nonferrous Metals and Alloys
Keep cathodic area small relative to active metal	

3-2 **WOOD AND TIMBER.** Wood and timber members have been used for construction and maintenance of waterfront facilities due to availability, economy, and ease of handling relative to other construction materials.

Common wood products used include: dimension lumber, timber, piles, and poles. Engineered wood products such as glued and laminated timbers (glulam) are common and, if, properly preserved or protected, may be used. Plastics and composites can be used as substitute materials for non-load bearing wood members. The primary applications at the waterfront include:

- Older piers, wharves, bulkheads, and quaywalls built from timber piles.
- Fender systems built from timber and round timber piles.
- Pile dolphins built from round timber piles.
- Floats and camels built from logs, timber, dimension lumber, glued and laminated wood, or miscellaneous forms.
- Groins built from timber and round timber piles.

\1\ One critical aspect of timber construction is connection hardware. Typically, bolts are used. Problems observed from hardware misalignment and corrosion are exhibited in terms of: “necking down” of bolt shank, distortion/enlargement of washer holes, and bolt heads popping off or being drawn through the washer. /1/

3-2.1 **Maintenance.** Maintenance of wooden structures involves replacing decayed or damaged wood with properly treated wood or other suitable material. If repairs are to be reduced in the future, exposed wood and pile caps must be treated with an effective preservative to retain its strength and longevity against destructive fungi, marine organisms, insects, and bacteria attack.

Many wood species are used for treated dimension lumber and timber in the United States. Primarily, Douglas fir is used on the West Coast and southern pine is used on the East Coast due to availability. See Unified Facilities Guide Specification \1\ UFGS-06 13 33, *Pier Timberwork* /1/ for proper Navy

procurement and product inspection criteria of pier timber work. Round timber piles for marine use are also usually made from Douglas fir or southern pine according to availability and size requirements for piling. For Navy use, these piles must conform to UFGS 31 62 19.13, *Wood Marine Piles*. /1/

All wood products, including treated wood, must be inspected by agencies certified by the American Lumber Standards Committee (ALSC) and must be properly graded and marked before acceptance. General Navy criteria for accepting wood products are well described in NAVFAC MO-312.2, *A Field Guide for the Receipt and Inspection of Treated Wood Products by Installation Personnel*.

3-2.2 **Wood Deterioration.** Biological and physical deterioration of wood can bring about rapid destruction of waterfront facilities. Improper design and construction procedures that lead to biological deterioration include:

- Inadequate preservative treatment.
- Improper handling of treated wood.
- A design that promotes retention of water.
- A design that unnecessarily places wood timbers below water.

Major design deficiencies, which promote physical deterioration, include:

- Insufficient strength of piles resulting in overloading (loss of strength and embrittlement caused by treatment with salts and other preservatives are an important design considerations).
- Improper connection hardware or pile connections that restrict load transfer to other parts of the structure.
- Inability of sheet pile walls to retain backfill or insufficient strength in the soil foundation that results in sheet pile movement.

3-2.2.1 **Biological Deterioration.** Wood-destroying organisms infest wood structures both above and below the waterline. Marine borers are the principle cause of deterioration in the immersed zones and are found in harbors and estuaries worldwide. Marine fouling organisms found on the wood surface do not cause wood deterioration and may even serve to retard marine borer damage. Insects and fungi are the main wood-destroying organisms above the waterline.

3-2.2.1.1 **Marine Borers.** There are two general types of marine borers that attack marine timbers: crustaceans and mollusks. The major wood-boring crus-

taceans are the Limnoriids; the principle wood-destroying mollusks are the Teredines (Teredo and Bankia) and the Pholads (Martesia). See Figure 3-1.

- Crustaceans. Of the three common crustacean wood borers - Limnoria, Sphaeroma, and Chelura - Limnoria is considered to be the most economically important. These borers burrow just below the wood surface forming a network of interlacing tunnels. The weakened wood is easily eroded by wave action often resulting in a characteristic "hourglass" shape. Limnoria tripunctata is of particular importance because it can attack creosoted wood.
- Teredines. The Teredines are commonly referred to as "shipworms" because of their wormlike appearance. Penetration of the wood occurs during the microscopic larval stage. As the shipworms grow, their tunnels increase in diameter and length while the entrance holes remain about the same size. Attacked piles may appear sound on the surface, yet be completely riddled.
- Pholads. Pholads bore into wood, soft rock, or concrete for protection. These clams have pear-shaped shells that can reach 6 cm in length. Like the Teredines, Martesia can cause considerable structural damage to wood, but both of these mollusks can be more effectively controlled by creosote preservative treatment than the Limnoriids.



Figure 3-1. Three groups of Marine Borers.<sup>1</sup>

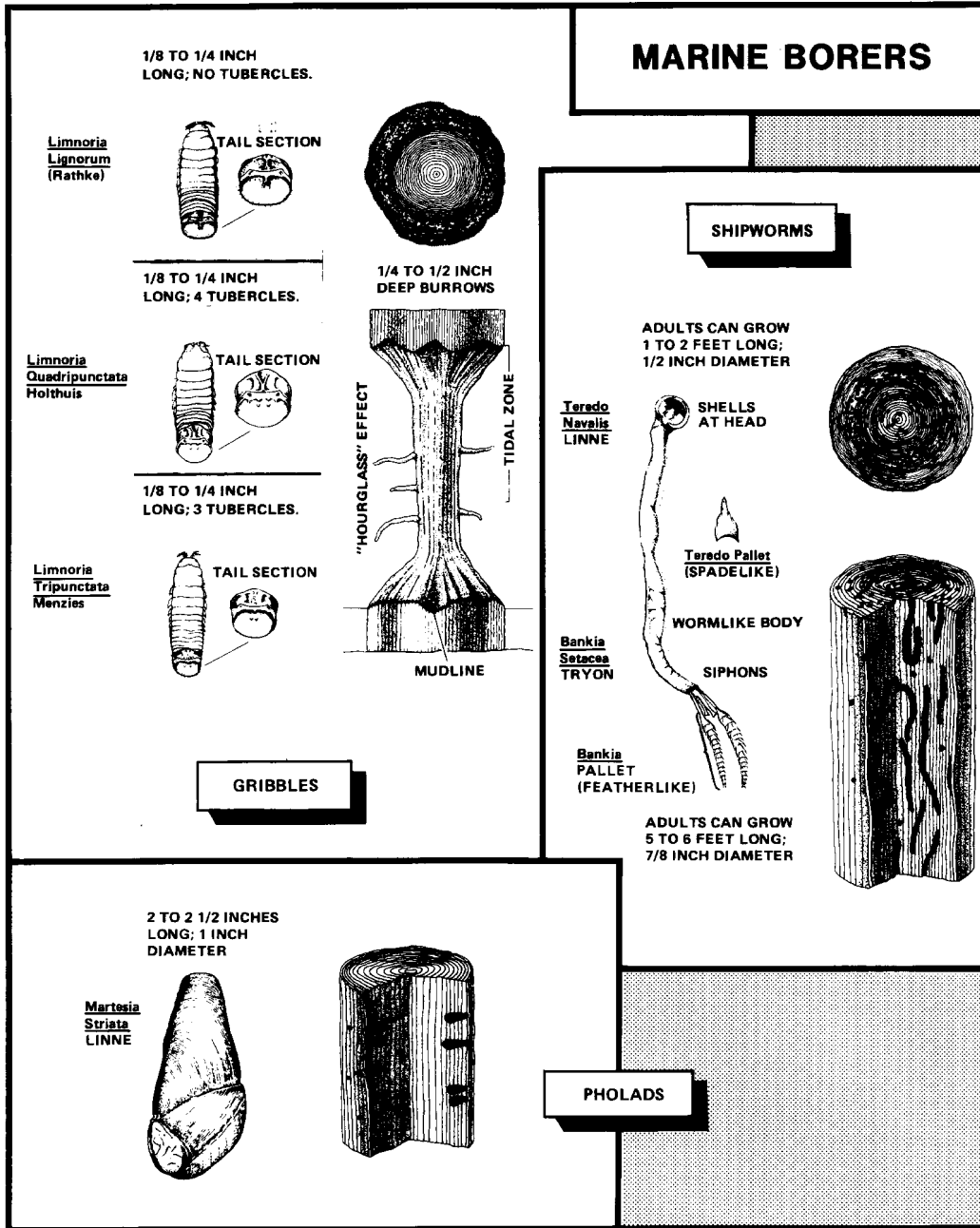

NOTE: Gribbles are 1/8 to 1/4 inch (3mm to 6mm) in length; Shipworms are 1 to 2 feet (30 to 60 cm) in length, 1/2 inch (12.7mm) in diameter; and Pholads are 2 to 2 1/2 inches (51mm to 63.5mm) in length.

<sup>1</sup> From Oregon State Research Bulletin 48, October 1984.

3-2.2.1.2 **Insects.** Termites are the most destructive wood-destroying insects found on waterfront structures. Other insect pests include: wood-boring beetles, ants, and bees. An insect frequently associated with damage to piers and docks is the wharf-borer, *Nacorda*, a beetle about 0.32 inch (8 mm) long, yellowish-brown to dark red in color. Some insects, such as termites, require wood for food and shelter; others, such as carpenter ants, require wood for nesting only. Most wood-destroying insects thrive under damp conditions.

3-2.2.1.3 **Fungi.** Three categories of wood-decay fungi are: white rot, which tends to bleach the affected wood; brown rot, often termed "dry rot," which produces a brown, crumbling type of decay; and soft rot, which softens the wood. Slight strength reduction of infected wood can be caused by stain fungi, which produce bluish black to steel gray or brownish discoloration of the wood. Molds also produce a discoloration of the wood surface and are regarded as merely a blemish, but their presence indicates that conditions may be favorable for decay organisms. Most wood-destroying fungi require damp conditions for growth.

3-2.2.2 **Physical Deterioration.** Physical deterioration of timber piles and other wood structures is generally due to the following causes:

3-2.2.2.1 **Abrasion.** Abrasion of timber piles occurs principally in the intertidal zone. The rate at which piles are destroyed by abrasion depends on the amount of floating debris in the harbor, the velocity of water moving past the piles, ice in the harbor, and the action of marine borers. Fender piles are also abraded by camels and ships.

3-2.2.2.2 **Overload.** Overloading of piles may result from a continuous heavy load or infrequent, severe loads. Overloading may be caused by vertical and horizontal loads. Failure of one pile requires the adjacent piling to carry the extra load. Continual overloading can lead to collapse of the entire structure.

3-2.2.2.3 **Connection Failure.** When a timber pile connection fails, the structure is free to move and will eventually fail. If untreated wood is exposed, connection failure may first allow the entry of marine borers if below the waterline, or insects and fungi if above the waterline.

3-2.2.2.4 **Timber Wall Movement.** Outward wall movement can result from horizontal loading of the backfill material caused by excessive loading behind the structure or failure of tie-backs. Loss of backfill material can result in movement in the opposite direction. If either condition continues, the structure will fail.

3-2.2.2.5 **Single Timber Piles.** Single timber piles or those used in light structures may be lifted by ice freezing to the pile and pulling it as the ice moves with the tide.

**3-2.3 Preventive Maintenance for Wood and Timber.** The primary preventive maintenance (PM) measure at the waterfront is to select the type of wood best suited for the particular use and to purchase wood products and timber piles that have been treated with quality preservatives and methods. Field techniques should be used to eliminate or minimize cuts and holes made in the members at the site, particularly for those members to be placed below water. If cuts and holes must be made, special field PM preservative treatment is required. In addition, there are other PM measures applicable to timber piles using encasements and retardants. The most important field PM for the exposed wood of waterfront buildings and related structures is the application of paint and other coatings. Preventive maintenance measures discussed in this section are summarized in Table 3-1.

**3-2.3.1 Pressure Treatment.** Pressure treatment of the outer sapwood of timbers with preservatives is the most important and effective method of protecting wood. Using pressure treatment allows the preservative to uniformly penetrate deeper and allows closer control of retention levels. The preservative penetrates the wood from .39 to 3.93 inches (1 cm to 10 cm), depending on the type of wood, and provides protection from fungi, marine borers, insects and bacteria. \1\ American Wood Protection Association (AWPA) /1/ Standards govern the treatment processes that must be performed on wood used in waterfront areas. MO-312.2, *A Field Guide for the Receipt and Inspection of Treated Wood Products by Installation Personnel*, is a field guide for acceptance of treated wood products and must be consulted by Navy activities and followed whenever treated wood is used.

The choice of preservative treatment depends on how and where the wood is to be used. Wood preservatives are classified in three categories: creosote preservatives, oil-borne preservatives, and water-borne preservatives.

**3-2.3.1.1 Creosote.** Creosote preservatives have been the most commonly used preservatives at the waterfront because they are not easily leached from the wood and are not corrosive to metals. Creosote and creosote-coal tar solutions, both derived from bituminous coal, can be used for immersed wood. Creosote is commonly diluted with petroleum oil for treatment of wood not subject to immersion. An important disadvantage of creosoted piling, however, is that it is readily attacked by the marine borer, *Limnoria tripunctata*. In addition, creosote and creosote solutions cannot be used where it may come in contact with people or where local environmental concerns have restricted its use in the marine environment. Consult your environmental office for the latest policies and regulations regarding its use.

**3-2.3.1.2 Oil-Borne.** Oil-borne preservatives are dissolved in a petroleum solvent and include pentachlorophenol, copper naphthenate, tributyl tin oxide, and copper-8-quinolinolate. Oil-borne preservatives are suitable for wood members out of the water for protection against insects and fungi but does not

provide adequate protection against marine borers and, thus, cannot be used for immersed wood. Treated wood can be painted, does not swell and distort, is easily handled, and will not corrode metal. Before the solvent evaporates, it is more flammable than untreated wood. Pentachlorophenol is the most effective of these preservatives but is also highly toxic. Consult the Consumer Information Sheet and your safety and environmental office before you consider using it.

**3-2.3.1.3 Water-Borne.** Water-borne preservatives are toxic metallic salts dissolved in water for easier application. The water-borne preservatives include chromated copper arsenate (CCA), ammoniacal copper zinc arsenate (ACZA), and ammoniacal copper arsenate (ACA). Wood treated with one of these water-borne preservatives can be used either above or below the waterline (wood used below the waterline is treated at higher retention levels). In addition, these salts in combination with creosote (dual treatment) are more effective in preventing marine borer damage than any single treatment. Other water-borne preservatives for use above the waterline include acid copper chromate (ACC), ammoniacal copper citrate (CC), and ammoniacal copper quat (ACQ)-Type B.

**3-2.3.1.4 Negative Aspects.** All preservative treatments have drawbacks that should be considered. Metallic salts, for example, will seriously embrittle wood. More importantly, these toxic chemicals present environmental and personnel safety concerns. All treated wood should be supplied with a Consumer Information Sheet that provides use, handling, and disposal precautions. Proper safety procedures should be carefully followed.

Plans for handling pressure-treated wood removed from service should be carefully considered, especially in areas where the disposal of treated wood may be restricted. Alternatives to landfilling include reuse as landscape timbers, recycled as fuel, etc. Wood treated with CCA should never be used as a fuel, and treated wood should not be recycled as mulch. Other restrictions may apply; Consult with your environmental office.

**3-2.3.2 Field Treating Exposed Areas of Wood Before Installation.** Cut surfaces of wood members, pile cutoffs, bolt holes, and any other exposed surfaces of treated wood members must be treated in the field before installation. All exposed, untreated wood should be treated in accordance with \1\ American Wood Protectors Association, Standard U1, *Use Category System: User Specification for Treated Wood /1/*. Treat holes for bolts and wood plugs inserted in piles and timbers with the same general type of wood preservative originally used for the member. Bolt holes should be treated under pressure with a mechanical bolt hole treater, if available, or thoroughly saturated. Wood preservatives are restricted use pesticides and must be applied in compliance with applicable standards. Consult your safety office or nearest EFD applied biologist.

Timber pile tops, cut off after the pile is driven, expose the untreated heartwood of the pile to rapid decay. AWWPA Standard U1 /1/ provides recommendations for preservative treatments for pile tops. Creosoted piles may be field treated with creosote solutions, or where particularly heavy coatings are required, a coal-tar roof cement meeting ASTM D4022/D4022M, *Specification for Coal Tar Roof Cement, Asbestos Containing*. Piles treated with ACA, ACZA, or CCA can be field treated with any of these water-borne preservatives. After field treatment, the pile top must be covered with a cap or bonnet consisting of two layers of tar saturated fabric, tar paper, or fiberglass cloth, which shall overlap the side of the pile at least 2 inch (5 cm) and securely fastened.

### 3-2.3.3 Remedial Treatment of Wood

**3-2.3.3.1 Fumigants.** Fumigants are used to prevent or eradicate fungal decay of large (6 by 6 inch (15 by 15 cm) or greater cross-sectional area) wood members. These products may be an available option in your area for waterfront structures. They are highly toxic, restricted use pesticides, and can be handled only by certified personnel. The most widely available product currently available is applied only by the manufacturer. Generally, an inspection of the prospective treatment site and a treatment plan is carried out by the contractor prior to actual treatments. Consult your environmental and safety offices before using these products.

**3-2.3.3.2 Brush On.** Brush on preservative pastes and bandages are commonly used as a remedial groundline treatment for southern pine utility poles. They may have some application to waterfront timbers. Diffusion of the preservative ingredients into the decayed portion of the wood depends on the moisture in the wood. Typically, the level of preservative penetration and long-term efficacy of these products is less than that of fumigants.

**3-2.3.3.3 Liquid Internal.** Liquid internal treatments are sometimes used when voids and cavities are present in wood. This treatment is not generally recommended for waterfront timbers. If voids and cavities are present, replacing the wood member is advisable.

**3-2.3.3.4 Solid Rod.** Solid rod treatments commercially available today are fused borate rods available in a variety of sizes. They are relatively easy and safe to handle. Like brush on pastes and preservative bandages, diffusion of the borate in these rods depends on wood moisture and the level of preservative penetration and long-term efficacy of these products is less than that of fumigants.

**3-2.3.3.5 Encasements and Retardants.** Two methods are available to protect timber pile tops by using encasements and retardants. They include:

- Remedial Treatment with Fumigant Vials. Commercial fumigant vials are embedded in the cut top of timber piles and slowly leach into the pile to retard and prevent rot. Holes are bored in the top of the pile, vials inserted, and the holes plugged with hardwood. See Figure 3-2. A pile cap can be installed (see following bulleted paragraph) after fumigants are applied. This method is useful where the pile top is accessible and subject to wetting by rain or spray. These are restricted use pesticides; application of fumigants over water is restricted in California and other areas. Consult your environmental or safety office before using.
- Pile Top Bonnet. This method uses liquid preservative in the pile top and a protective bonnet or cap fabricated of two layers of tar saturated fabric or tar paper or fiberglass. Formation of reservoir is optional. See the Paragraph entitled, "Field Treating Exposed Areas of Wood Before Installation" for selecting a preservative. This method can be used to repair a rotted pile top, as shown in Figure 3-3, or as a preventive measure on a sound pile.

**Figure 3-2. Fumigant Vials for Timber Piles**

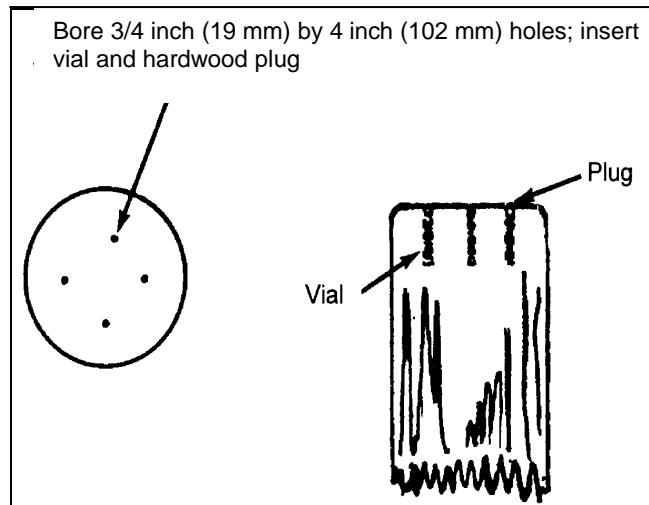
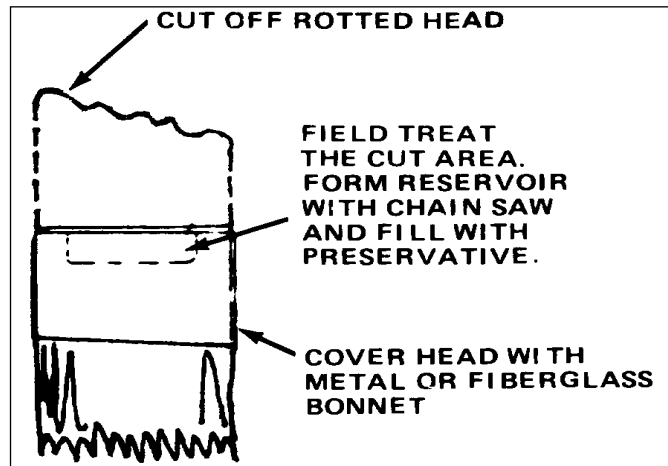

Figure 3-3. Pile Top Bonnet for Timber Piles



3-2.3.4 **Coatings for Wood Buildings.** Wooden structures continuously immersed in seawater or subject to immersion during tidal changes are not usually painted except for marking identification or location. In general, coating wood is confined to structures such as buildings located in waterfront areas to protect the wood from weathering and for appearance. Surface preparation of either previously coated wood or uncoated wood may consist of the following procedures:

- 100% removal of biological growth,
- removal of unsound coatings,
- removal of surface contamination such as oil, grease, dirt,
- light sanding of sound coatings and exposed wood.

Two coating systems may be used for either previously coated wood or uncoated wood as follows:

- 40% volume solids, exterior latex (water-based): 1 or 2 coats at 1.97 to 5.9 mils (0.05 to 0.15 mm) dry film thickness (DFT)
- 55% volume solids, flexible acrylic waterborne (water-based): 1 or 2 coats at 3.94 to 11.81 mils (0.1 to 0.3 mm) DFT.

3-2.3.5. **Protection of Timber Piles.** All timber piling in the marine environment, including piling properly treated, are eventually attacked by wood destroying organisms. Pilings are also commonly subjected to ice lift and

abrasion. As a result, protection with plastic wraps is often required, in order to minimize the impact of these environmental factors. In tropical environments, such as Roosevelt Roads, Puerto Rico, even dual-treated piling should be wrapped.

The use of plastic wrapping to protect piling against marine borer damage, at and below the waterline, does offer considerable economic benefit by effectively eliminating borer damage, reducing future repair costs. The polyvinyl chloride (PVC) or polyethylene wrapping smothers borers already in the wood and prevents the entry of more borers. Installation of barrier wraps are described in repair technique TR-3 in Chapter 6. Fender piles pre-wrapped with a thick, heat-shrink polyethylene provides a slippery surface that prevents exposure of untreated wood due to wear from camels. An example of a molded polyethylene jacket used for ice protection is shown in Figure 3-4.



Figure 3-4. Timber Pile Jacket for Ice Protection

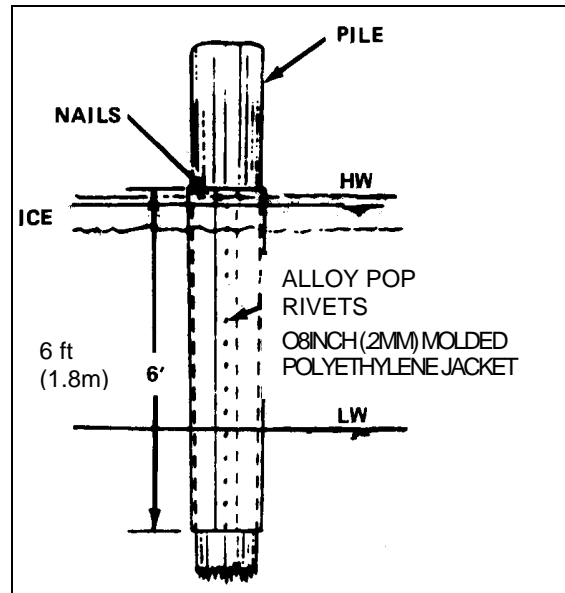

3-3 **CONCRETE.** Reinforced concrete is the predominant construction material for waterfront facilities due to its durability, strength, and economy as a bulk construction material. Steel and wood do not have the bulk properties and adaptability of concrete. In addition, basic components to make reinforced concrete are readily available at most locations. Applications of reinforced concrete at the waterfront include:

- Seawalls, bulkheads (quaywalls), and revetments use reinforced concrete as the dominant material of construction. It is used as the facing material to absorb wave impact, retain fill, and reduce the erosive effects of wave action. Concrete is used in piles, curved-faces, sheet piling, and other forms.
- Piers and wharves are usually built with reinforced concrete. Concrete is also used to protect wood or steel from corrosion, weathering, fungal decay, or marine organism attack. Prestressed concrete fender piles are effective and long lasting.
- Groins are built from concrete sheet piles and panels. The piles or panels are usually prestressed units and are tied in place with a concrete cap.
- Breakwaters use various shapes of precast concrete. These interlocking building blocks can be assembled in various shapes.

- Submerged structures use reinforced concrete that are cast in place or precast and used to support pilings and structures.
- Floating structures use reinforced concrete for pontoons, quays, wharves, piers, and facilities for small boats.
- Drydocks are made of reinforced concrete.

3-3.1 **Deterioration.** Deterioration of reinforced concrete near or in seawater is due to corrosion of the reinforcement. This corrosion can be accelerated due to improper concrete mix, insufficient concrete cover (thickness of concrete over the reinforcing steel), improper curing, operational loads, chemical attack, and volume changes. Using well established mix designs and construction practices, however, will enhance reinforced concrete durability.

Reinforced concrete in waterfront facilities must meet the criteria set by the American Concrete Institute (ACI) Standard 318, *Building Code Requirements for Structural Concrete*. This standard covers the building code requirements for concrete with and without reinforcing. Additional design information, with emphasis on waterfront facilities, is included in UFC 4-151-10, *General Criteria for Waterfront Construction*. These manuals provide general design and application data for a variety of waterfront structures. Unified Facilities Guide Specification UFGS 03 31 29, *Marine Concrete*, provides guidance for cast-in-place concrete subject to exposure to the marine environment. Unified Facilities Guide Specifications UFGS 31 62 13.13, *Cast-in-Place Concrete Piles*, UFGS 35 59 13.13, *Prestressed Concrete Fender Piling*, and UFGS 31 62 13.20, *Precast/Prestressed Concrete Piles*, provide guidelines on concrete piling.

3-3.2 **Components of Concrete.** Concrete is a mixture of Portland cement, coarse and fine aggregate, and water. Various admixtures, and pozzolans may be used to improve the strength, workability, and service life. Preparation and proportioning of concrete mixtures should follow the recommendations of the Portland Cement Association's, *Principles of Quality Concrete*, and ACI 211, *Recommended Practice for Selecting Proportions for Concrete*.

3-3.2.1 **Cement.** Five types of Portland cement are described in ASTM C150 / C150M, Standard Specification for Portland Cement. For concrete structures exposed to seawater, Types II and V should be used. Type II is a sulfate-resisting cement. Type V, however, is no longer being produced. Low alkali cements should be used with potentially reactive aggregates.

Do not use any product containing sodium or calcium, as it will likely accelerate the onset of rebar corrosion.

3-3.2.2 **Aggregates.** Aggregates are used in concrete mixtures to improve durability and reduce costs. They usually make up 60 to 80 percent of the volume

of the concrete. The shape and size of the aggregate should meet the requirements specified in ASTM C330/C330M. Aggregates are a mixture of sand and rock. Marine aggregates, such as coral, should not be used. However, if marine aggregate is the only available material, it must be washed thoroughly with freshwater to remove the salt.

In some applications, special aggregates may be used to make lightweight concrete for lightweight structures. Most lightweight concretes have a density between 79.9 and 109.87 pounds/cubic foot (1,280 and 1,760 kg/m<sup>3</sup>) compared to 149.83 pounds/cubic foot (2,400 kg/m<sup>3</sup>) for normal weight concrete. Lightweight aggregate concrete is generally more durable in the marine environment than concrete made with normal weight aggregate.

**3-3.2.3 Water.** Water quantity and quality will affect the durability, strength, and workability of concrete. In practice, use water equal in quality to drinking water. The ratio of water to cement has a direct effect on the strength of the concrete and its permeability. A maximum water-to-cement ratio of 0.40 by weight is crucial for concrete used in a marine environment. Seawater should never be used for making concrete because the salts will dramatically increase the corrosion rate of reinforcing steel.

**3-3.2.4 Admixtures.** Various chemical admixtures are used to give specific properties to the concrete to improve durability, finishability or workability. If admixtures are required, they should meet the appropriate ASTM or ACI specifications.

**3-3.2.4.1 Water Reducing.** Water-reducing admixtures are available to allow a reduction in the water-to-cement ratio while maintaining a workable slump. Normal range water reducers and superplasticizers are admixtures that permit the reduction of the water-to-cement ratio.

**3-3.2.4.2 Air-Entraining.** Air-entraining admixtures are available to improve the concrete's ability to resist freeze-thaw conditions and enhance workability. Air-entraining agents should be used to incorporate from 5 to 7 percent of entrained air into the concrete. \1\ ASTM C233 / C233M, Test Method for Air Entraining Admixtures for Concrete /1/, covers the air-entraining agents. Air-entraining agents also improve the workability of the concrete.

**3-3.2.4.3 Accelerator.** Accelerator admixtures are available for rapid setting products. These increase the early strength of concrete but have little effect on the final strength. Accelerators containing excessive chloride should not be used since they increase corrosion of reinforcing steel.

**3-3.2.4.4 Pozzolan Minerals.** Pozzolan minerals (fly ash Class F) are highly recommended as a replacement of 25% of the Portland cement. The ash reduces permeability, eliminates alkali-silicon reactions, and improves

workability. Silica fume can reduce permeability but may cause finishing problems and surface cracks. Avoid silica fume dosages about 5% by weight to concrete.

**3-3.3 Reinforcing Steel.** Reinforcing steel for concrete in waterfront facilities is the same as for conventional concrete structures and should conform to ASTM A615, *Specification for Deformed and Plain \1\ Carbon-Steel /1/ Bars for Concrete Reinforcement \1\* or ASTM A996/A996M, *Specification for Rail-Steel and Axle-Steel Deformed Bars for Concrete Reinforcement /1/*. Place 3.15 inch (8 cm) concrete cover, which is critical for durability, over the plain steel. \1\ /1/

**3-3.4 Special Types of Concrete Mixtures.** Special concrete mixtures include polymer concrete and polymer-Portland cement concrete. Concrete mixtures containing polymers are useful for repairing concrete and may provide improvements over conventional concrete mixtures when used and applied correctly.

**3-3.4.1 Polymer .** Polymer concrete does not contain Portland cement. Epoxy concrete is one common type of polymer concrete that is readily available and possesses excellent bond and tensile strength qualities. Use extreme caution when using polymer concretes for structures subject to thermal resistance due to a high coefficient of thermal expansion that often results in repair failure.

**3-3.4.2 Fiber Reinforced.** Fiber reinforcements may improve the tensile strength, toughness, and ductility of concrete. In general, steel fibers should not be used in the marine environment. Polypropylene fibers avoid the corrosion problem of steel fibers and improve impact resistance. Fiber should not be considered as a replacement for the reinforcement.

**3-3.5 Causes of Concrete Deterioration.** Cracking and spalling of concrete are the results of chemical attack and rebar corrosion.

**3-3.5.1 Chemical Attack.** The most common chemical attack is from sulfates in seawater that cause a softening of cement paste. Other causes of chemical attack are poor quality aggregates reacting with alkali in the cement (alkali-aggregate reaction). The alkali-aggregate reaction expands the aggregate and results in cracking throughout the concrete in the presence of moisture. Use of 25% Class F fly ash is extremely effective in reducing chemical attack.

**3-3.5.2 Corrosion of Reinforcing Steel.** The high alkalinity of cement paste protects steel from corrosion. With improper mix designs, chloride contamination and carbonation eventually reduce the alkali film around the steel. Corrosion will then occur if sufficient moisture and oxygen are present. In the splash zone, the wet and dry cycles provide conditions for the chloride and oxygen to corrode the steel. Accordingly, steel corrosion in concrete is most severe directly above the mean low water (MLW).

When steel corrodes, the rust product increases in volume many times over its original volume. Expansion of the rust causes cracking of the concrete. These cracks run parallel to the reinforcement. Eventually, concrete covering the reinforcing steel spalls off.

**3-3.5.3 Cracking of Concrete.** As concrete dries it shrinks, which in turn, can cause cracks. These cracks may increase in size as the internal water is lost over time and the concrete cannot contract freely. Temperature changes can also cause cracking. In addition, freezing water in the concrete can lead to deterioration, cracking, and spalling. Overload conditions can cause cracks. Waterfront structures are subject to settlement conditions. When settlement is uneven, cracks usually result.

Shrinkage cracking can be minimized by proper curing and using a minimum amount of cement and water in the mix. Temperature cracking can be controlled in concrete by using expansion joints and temperature reinforcement. Air entrainment is critical to minimize freeze-thaw damage.

Prevention and control of cracking may be improved by proper design of the concrete structure and measures taken during construction. The measures that must be taken during repair of concrete structures are discussed in Chapter 7.

**3-3.6 Preventive Maintenance for Concrete.** Measures to minimize deterioration of reinforced concrete must be taken during design of the structure and during construction. Proper design for concrete is contained in ACI standards and service design manuals.

The main objectives of preventive maintenance are to:

- Keep water out of the concrete.
- Protect the reinforcing steel.
- Prevent and control cracking.
- Prevent chemical actions.

The primary PM measure that should be considered for existing reinforced concrete structures is the application of a surface coating. Coatings should be reapplied periodically to concrete that was coated when new. This measure can be applied to old concrete but rebar corrosion, the principal cause of concrete deterioration and the reason these PM measure are applied, will not likely be inhibited.

The treatment of cracks, described briefly in this Chapter, is best considered as a repair technique and is presented in detail in Chapter 7.

**3-3.6.1 Surface Coatings for Concrete Waterfront Structures.** Sound concrete piles and other waterfront concrete structures are generally left uncoated and provide years of excellent service. Existing concrete structures, above the splash zone, however, may be successfully coated for aesthetics, for marking purposes, and for protection against wind driven rain and sand, and salt spray. The application of a coating over a penetrating sealer is not recommended because the sealer reduces the bond strength of the coating to the concrete.

It is both difficult and labor intensive to coat immersed concrete and concrete in the splash zone. These areas require using either cofferdams or divers to apply "splash zone mastics," high performance coatings that cure underwater, and other specialty coatings. The benefit of applying these coatings, however, may not warrant the high cost.

**3-3.6.2 Coatings for Deck Marking.** For use in identifying walkways and traffic lines, the following marking paints may be applied to clean/dry concrete decks.

- 54% volume solids, solvent-based, chlorinated rubber: 1 coat at 7.87 to 9.84 mils (0.2 to 0.25 mm) DFT
- 50% volume solids, solvent-based alkyd: 1 coat at 7.87 to 9.84 mils (0.2 to 0.25mm) DFT
- 60% volume solids, waterborne acrylic (water-based): 1 coat at 7.87 to 9.84 mils (0.2 to 0.25mm) DFT

**3-3.6.3 Other Coatings.** Concrete buildings above the splash zone may be coated for aesthetics and protection against wind driven rain. Surface preparation of concrete surfaces may consist of the following sequential procedures:

- 100% removal of biological growth
- removal of unsound coatings
- removal of surface contamination such as oil, grease, dirt, and efflorescence
- removal of weak surface cement (laitance)
- removal of surface chloride contamination
- brush-off blasting of sound coatings
- light abrasive blasting of uncoated concrete

The below acrylic system may be used as an overcoat for sound coating systems whereas all three systems are acceptable for use on uncoated concrete.

- 55% volume solids, flexible acrylic waterborne (water-based): 1 to 2 coats at 3.94 to 15.75 mils (0.1 to 0.4 mm) DFT
- Two-component, epoxy polyamide primer followed by two coats of a flexible acrylic topcoat: 3 coats at 19.67 mils (0.5 mm) total DFT (5.9 mils (0.15 mm) primer, 7.87 mils (0.2 mm) topcoat)
- Two-component, epoxy polyamide primer followed by two coats of a two-component, aliphatic urethane topcoat: 3 coats at 9.84 mils (0.25 mm) total DFT (5.9 mils (0.15 mm) primer, 3.94 mils (0.1 mm) topcoat, 3.94 mils (0.1 mm) topcoat)

3-3.6.4 **Treatment of Cracks.** Cracks in concrete are typically caused by shrinkage during curing, thermal expansion and contraction, rebar corrosion, operational loading, or structure settlement. Cracks are routed out and repaired using a flexible elastomer over bond-breaker tape. Hairline cracks may be repaired by pressure injecting polyurethane or methyl methacrylate through injection ports. Chapter 7 provides details of materials and procedures to use to repair both static and dynamic cracks in concrete.

3-4 **STEEL.** Steel is used extensively in construction and repair of waterfront facilities due to availability, cost, ease of fabrication, physical and mechanical properties, and design experience. Structural steel and cast or fabricated steel are used in all areas of the waterfront. Typical applications include:

- Piers and wharves use steel H-piles or pipe piles to support or brace the structure. Structural steel shapes are used for framing.
- Bulkheads and quaywalls use interlocking steel sheet piling with tie rods and wales. Steel sheet piling is used to retain fill.
- Fender systems incorporate steel H-piles.
- Mooring hardware such as cleats, bollards, bitts, and chocks are made from cast or fabricated steel.
- Other items such as utility lines, grating, opening frames, manhole covers, fences, bolts and nuts, handrails, and concrete reinforcement are made of steel.
- Steel components are used in some camels.

Maintenance of steel structures and components will entail repair or replacement of damaged or corroded steel, periodic coating of steel surfaces for corrosion protection, and maintenance of cathodic protection systems. Although physical damage from impact or loading may occur, corrosion is the major cause of the deterioration of steel structures. The extent or severity of corrosion will vary with the exposure zone of the material; that is, whether it is in the atmospheric zone, the splash or tidal zone, or the submerged zone. The selection of materials for waterfront use must consider each of these varied conditions. \1\ Additionally, instances of failure of steel structures, i.e. sheet pile bulkheads with interior wales resulting from galvanic incompatibility have occurred. Consult NFESC metallurgist for proper selection of materials. /1/

The use of steel should follow design guidelines in \1\ UFC 4-151-10, *General Criteria for Waterfront Construction*; UFC 3-301-01, *Structural Engineering*, /1/ and the American Institute of Steel Construction's *Manual of Steel Construction*. The material specifications of ASTM and other organizations document chemical and physical characteristics of the various types of steel. Material selection and procurement should conform to these specifications.

**3-4.1 Steel for Waterfront Construction.** Carbon steel and carbon steel alloys are the most important types of metals used for construction of waterfront facilities. In general, only low carbon steels with a carbon content less than 0.35 percent by weight are used due to welding characteristics.

**3-4.1.1 Carbon Steel.** Carbon steel is an alloy of iron and carbon with a carbon content less than 2 percent. The requirements for structural carbon steel are contained in ASTM A36/A36M and this grade is suitable for welding.

Carbon steel will corrode in all exposure zones, but the most severe corrosion occurs in the splash zone and just below MLW. Coatings and cathodic protection are necessary to prevent excessive corrosion of steel in the waterfront environment. Coatings are covered in the Paragraph entitled, "Protective Coatings for Steel". Cathodic protection is covered in the Paragraph entitled "Cathodic Protection of Steel".

**3-4.1.2 Low-Alloy Carbon Steels.** Corrosion resistant, low-alloy carbon steel may be used instead of carbon steel if greater corrosion resistance is required. Low-alloy carbon steels contain small amounts of other elements such as copper, chromium, nickel, molybdenum, silicon, and manganese. Up to 1.5 percent of these elements is added for increased strength or heat treatment capability. These alloys have a better resistance to corrosion because the rust does not easily break away from the metal surface.

The common low-alloy steels include:



- ASTM A690/A690M, \1\ Specification for High-Strength Low-Alloy Nickel, Copper, Phosphorus Steel H-Piles and Sheet Piling with Atmospheric Corrosion Resistance for Use in Marine Environments /1/, (also called "Mariner steel").
- ASTM A572/A572M, *Specification for High-Strength, Low-Alloy Columbium-Vanadium \1\ Structural Steel /1/*.
- ASTM A242/A242M, *Specification for High-Strength, Low-Alloy Structural Steel*.

Steel conforming to ASTM A690/A690M is recommended for steel H-piles and sheet piling, because of its greater corrosion resistance over plain carbon steel in the splash zone. The low-alloy steels offer no more resistance to corrosion than ordinary carbon steel, however, when submerged. Under this condition, the low-alloy steels require coatings or cathodic protection, or both. Composite piles of ASTM A690/A690M and ASTM A36/A36M, *Specification for \1\ Carbon /1/ Structural Steel* may be used when more resistance in the splash zone is required. ASTM A242/A242M steels are not recommended for buried structures, submerged conditions, and marine atmospheres unless they are exposed to the wind, rain, and sun.

Coatings for, and cathodic protection of, low-alloy steels are the same as for plain carbon steel as discussed in the Paragraph entitled, "Preventive maintenance for Steel".

3-4.1.3 **Stainless Steels.** Stainless steels have application in the marine environment under certain conditions. They do well when exposed to wind, rain, sun, or high-velocity conditions in seawater. In calm or stagnant waters, salt spray zones, or in buried conditions, corrosion is likely to occur. Stainless steels in the 300 series (302, 304, 316) are substantially more corrosion resistant than the 400 series stainless steels. Except in certain atmospheric environments, stainless steels should only be used for specialized applications where performance experience has been superior to more commonly used materials to justify the high cost.

3-4.2 **Deterioration of Steel.** Although exposure to the atmosphere, severe temperature changes, and wind erosion all contribute to the deterioration of steel in waterfront facilities, exposure to saltwater is the major concern. Corrosion rates of metals exposed to seawater are much higher than those of similar metals exposed to freshwater.

Biological fouling, the growth of marine organisms on the steel, also contributes to increased corrosion. This type of fouling can be decreased by using antifouling coatings.

The other major causes of deterioration are: wave and current effects, abrasion from objects, and elements in the seawater.

**3-4.3 Preventive Maintenance for Steel.** The primary preventive measures available to increase the life of steel are protective coatings and cathodic protection. The decision of which approach to use is a function of location on the waterfront structure (submerged or not) and economics. The use of cathodic protection is restricted to submerged or buried structures.

**3-4.3.1 Protective Coatings for Steel.** Steel in a marine environment will corrode freely if left unprotected and without a coating system. Coating systems are designed according to three marine zones:

- constantly submerged
- intertidal and splash zone
- above the splash zone

Steel in the submerged zone is best protected through a combination of a coating system and cathodic protection. Maintenance coating systems are employed as follows:

- Overcoats on sound coatings
- Repairs to coating systems with spot failing
- Complete reapplication where coating systems have failed

Surface preparation of previously coated steel may consist of the following sequential procedures:

- 100% removal of biological growth
- removal of unsound coatings and rust
- removal of surface contamination such as oil, grease, dirt
- removal of surface chloride contamination
- brush-off blasting of sound coatings
- abrasive blasting of uncoated steel to produce an angular anchor profile between 2 to 3 mils (0.05 to 0.08 mm)

**3-4.3.2 Coating Systems.** The below coating systems have displayed high performance and may be used for either spot repairs or complete reapplication. It

is recommended that a coating specialist be contacted prior to specifying one of the below coating systems for overcoating sound coatings. DOD and other Federal activities may wish to contact an NFESC coating specialist.

#### 3-4.3.2.1 Submerged

- Underwater cure, two-component, 100% solid liquid epoxy: 1 to 2 coats at 7.87 to 11.81 mils (0.2 to 0.3 mm) DFT
- Underwater cure, two-component, 100% solid epoxy putty: 1 coat at 118.1 to 236.22 mils (3 to 6 mm) DFT

#### 3-4.3.2.2 Intertidal/Splash Zone

- Two-component, coal tar epoxy: 1 to 2 coats at 7.387 to 15.75 mils (0.2 to 0.4 mm) DFT
- Single-component, coal tar urethane: 1 to 2 coats at 3.94 to 11.81 mils (0.1 to 0.3 mm) DFT
- Three-component, aggregate-filled epoxy: 1 coat at 118.1 to 236.22 mils (3 to 6 mm) DFT
- Additional systems are presented in \1\ UFGS 09 97 13.26, *Coating of Steel Waterfront Structures. /1/*

#### 3-4.3.2.3 Above Splash Zone

- Two-component epoxy polyamide primer followed by two coats of a two-component, aliphatic urethane topcoat: 3 coats at 9.84 mils (0.25 mm) DFT (5.9 mils (0.15 mm) primer, 3.94 mils (0.1 mm) topcoat, 3.94 mils (0.1 mm) topcoat)
- Single-component, zinc-rich urethane primer followed by two coats of a single-component, aliphatic urethane topcoat: 3 coats at 7.87 mils (0.2 mm) DFT (3.94 mils (0.1mm) primer, 3.94 mils (0.1 mm) topcoat, 3.94 mils (0.1 mm) topcoat)
- Two-component epoxy polyamide primer followed by two coats of a flexible acrylic topcoat: 3 coats at 19.67 mils (0.5 mm) DFT 5.9 mils (0.15 mm) primer, 7.87 mils (0.2 mm) topcoat, 7.87 mils (0.2 mm) topcoat)

**3-4.3.3 Cathodic Protection of Steel.** The natural corrosion of steel structures immersed in water or buried in soil can effectively be controlled by using anodes and direct current systems to minimize or stop the corrosion

process, by establishing the steel as a cathode. Cathodic protection systems are best installed when the structure is constructed, but can be added to existing structures. They can effectively stop corrosion but cannot restore the material already lost by corrosion. Design and maintenance of cathodic protection systems can be found in \1\ UFC 3-570-02N, *Electrical Engineering Cathodic Protection*. /1/

**3-4.3.3.1 Galvanic Anode.** Galvanic anode cathodic protection systems rely on the corrosion of active metals such as zinc, magnesium or aluminum to generate the electrical current needed to protect buried or submerged steel structures. Since these anodes are sacrificed to protect the structure, they are known as sacrificial anodes. The anodes must be buried or submerged near the structure to be protected and electrically connected to it with a low resistance bond. As the anodes are consumed, they must be periodically monitored and replaced when over 80 percent of the metal is consumed, or when they will be consumed before the next scheduled inspection. The level of protection provided can be determined by measuring the potential of the structure being protected by comparison with a standard reference electrode.

**3-4.3.3.2 Impressed Current.** Impressed current cathodic protection systems use an external source of electrical alternating current, and a rectifier, to provide the protective direct current to be impressed across the system. This system also requires anodes buried or submerged in the vicinity of the structure being protected, but these anodes can last much longer than galvanic anodes, since they only conduct the protective current into the water or soil and are not the source of the current. Impressed current cathodic protection systems also require periodic inspection and maintenance to ensure effectiveness in controlling corrosion.

**3-5 NONFERROUS METALS AND ALLOYS.** A variety of materials are available that, if used properly, are more resistant to corrosion by seawater and marine atmosphere than steel. These materials are used for specialized applications and are not used as much as steel due to higher costs. The common nonferrous metals are aluminum, copper, nickel, titanium, and alloys of each.

**3-5.1 Aluminum.** Many alloys of aluminum are available for applications requiring high corrosion resistance to the marine atmosphere as well as good strength-to-weight ratios. The common uses of aluminum at the waterfront include: Brows and platforms, decking and catwalks, and light poles and bases.

Aluminum should not be used as a substitute for steel solely for its corrosion resistance quality. Aluminum and its alloys are subject to pitting and crevice corrosion in marine environments, especially in submerged conditions. If pitting can be tolerated and crevices eliminated, aluminum alloys may be used successfully where low weight and other unique properties are required.

ASTM specifications define compositions and mechanical properties of aluminum alloys. Alloys 5083, 5086, 5052 and 6061 are the most popular alloys for structures exposed to the marine atmosphere.

3-5.2 **Copper.** Copper and copper alloys are suitable for waterfront use because of their uniform, low corrosion rate. Copper is used for electrical conductors, pipe, sheathing, and many hidden uses on supporting equipment at the waterfront. The copper alloys usually selected for marine corrosion resistance are: copper, cupro-nickel 90-10, cupro-nickel 70-30, arsenical admiralty brass, and most true (zincless) bronzes. These alloys form films of corrosion products that provide protection even in flowing water.

3-5.3 **Nickel.** Nickel base alloys have good corrosion resistance to seawater and to cavitation damage. These materials are used for specialized applications in springs, cable connectors, expansion joints, rupture disks, valves, fasteners, heat exchangers, and piping. The high cost of these materials makes them unsuitable for bulk construction at the waterfront.

The most common nickel alloys used are: Inconel Alloy 625 (nickel-chrome alloy), Hastelloy Alloy "C" (nickel-chrome-molybdenum alloy), and Monel 400 (nickel-copper alloy). Inconel and Hastelloy "C" are essentially immune to corrosion in marine environments. Monel 400 has good corrosion resistance when it has been cathodically protected with a more active metal. If not protected, Monel will develop pitting and crevices.

3-5.4 **Deterioration of Nonferrous Metals and Alloys.** Nonferrous metals and alloys will corrode and develop pits and crevices under normal atmospheric conditions. In general, these metals are not given preservative coatings, but may be painted for color/appearance in certain uses. Corrosion rates can be greatly accelerated when two or more dissimilar metals are in contact with each other and exposed to a corrosive environment. Particularly when they are buried or submerged, accelerated corrosion of one of the metals can occur due to an electrochemical reaction called galvanic corrosion. Galvanic corrosion rates depend on the metals' electrical properties and the medium in which the metals are exposed. Galvanic series tables have been developed indicating lists of metals in order of decreasing corrodibility when exposed to a certain solution or medium. Generally, the closer one metal is to another in the galvanic series, the lower the corrosion rate with the more active metal, and conversely, the further apart, the greater will be the corrosion rate of this metal.

3-5.5 **Preventive Maintenance for Nonferrous Metals and Alloys.** PM measures depend on whether or not dissimilar materials are involved:

- Similar Nonferrous Metals and Alloys. The only formal PM measure is regular and careful inspection to determine the condition of the component. In the later part of a component's life expectancy, it

may prove economical to coat the metal to prevent further corrosion rather than to replace the component.

- Avoiding Galvanic Corrosion. Galvanic corrosion can effectively be eliminated by making the structure out of as much of the same metal as possible, placing a protective insulator between the two dissimilar metals, and by providing cathodic protection if buried or immersed. When galvanic corrosion cannot be effectively eliminated, it can be reduced by using appropriate protective coatings on the steel, ensuring not to coat the anodes. Detailed information on treatments of galvanic corrosion is given in MIL-STD-889B, *Dissimilar Metals* for metal exposed to the saltwater environment.

If dissimilar metals must be joined, the following preventive measures should be taken:

- Choose metals close together in the galvanic series.
- Keep the cathodic area small in relation to the anode area; for instance, bolts or screws of stainless steel for fastening aluminum sheets, but not the reverse.
- Provide a protective insulator between the two metals.
- Use special coatings on the metals.

3-6 **SYNTHETIC MATERIALS.** Numerous synthetic materials are used in waterfront facilities and components. They are extremely versatile in application and serve as a structural material, coating material, or buoyancy material. In general, these materials do not corrode in the marine environment, but deteriorate due to other reasons, such as water absorption and swelling and degradation by ultraviolet light. The common synthetic materials include:

- Fiber-reinforced plastics (FRP)
- Foams, rubbers, and elastomers
- Plastic pile wraps and piping
- Synthetic fibers
- Adhesives

Deterioration of these synthetics, other than physical damage, increases with aging; plastics crack or separate, some become brittle; foams crumble with age

and lose resiliency; and elastomers stretch and deteriorate from the effects of sun and exposure. In general, no preventive maintenance measures are performed other than inspection. Certain materials and components can be economically repaired when damaged.

3-6.1 **Fiber-reinforced Plastics (FRP).** FRP are used for applications requiring high strength-to-weight ratios and resistance to deterioration, such as:

- Pile jackets for steel, concrete, and timber piling to reduce corrosion or erosion; for reinforcement; and to prevent marine borer attack.
- Lightweight, sandwich construction for small buildings and containers.
- Floating structures, such as buoys and landing floats, when used in combination with closed-cell foams.
- Deck hardware such as lighting posts, grating, utility line hangars, and handrails on piers.
- Filament wound piping for lightweight, low temperature pipelines transporting steam condensate, seawater, freshwater, sewage, oil, and potable water.

Carbon fiber sheets, strips, and rods are used to upgrade existing pier decks. The sheets and strips can be used by bonding them to the underside of the deck and the rods embedded into the top deck for negative reinforcement. These techniques can increase the shear capacity of the deck to permit greater loads. For more information see Chapter 7 on concrete.

FRP are a composite of resin and fibrous material. The common resins are polyester and epoxy. Polyester resins are general purpose resins that cost less than epoxy. Epoxy resins have superior strength properties, greater resistance to chemical and water degradation, and lower shrinkage during curing.

Materials used as reinforcement for FRP include: continuous strands, woven cloth, chopped fibers, and in some cases, glass flakes.

3-6.2 **Plastic and Fiberglass Piles.** Piles made primarily of plastic or fiberglass are being used as replacements for timber fender piles. Among the plastic piles are recycled plastic piles of which there are two basic types. One type uses a steel pipe core encapsulated in a mixture of high density and low density polyethylene. The second uses either steel or fiberglass rebar as the reinforcement in high-density polyethylene (HDPE). Early versions of the plastic piles had problems associated with cracking of the outer skin. Later editions of

the plastic piles have had fewer cracking problems attributed to them. In addition to the plastic piles, there are fiberglass piles that consist of a fiberglass tube, which can be filled with concrete for increased strength. The fiberglass piles have performed extremely well as fender piles.

In general, the fiberglass tube type piles that are filled with concrete provide more stiffness than the plastic piles. However, the fiberglass piles are vulnerable to abrasion. High-density polyethylene or ultra high molecular weight polyethylene (UHMW) should be used as a rub strip on the fiberglass fender piles. Both the plastic and composite fender piles have been employed successfully at many Navy piers. Most of the plastic and composite piles have been used as part of the secondary fendering system. It is recommended that the plastic and composite piles not be used as the primary fendering system at this time. Furthermore, the plastic and composite piles are not recommended for use as bearing piles. Currently, there are no ASTM or other industry standards for these piles, but they are being developed.

**3-6.3 Foams.** Foams are used at the waterfront as filler material for sandwich construction, to provide buoyancy for buoys; landing floats; and floating brows, and in foam-filled fenders to absorb the energy of berthing ships. Foams are resistant to deterioration in the marine environment if encased in an impermeable, durable material.

The common foams are polyurethane, polystyrene, polyethylene, and foams formed of ionomer resins. Polyurethane foams can be foamed on-site. However, before the foam hardens it is unstable in direct sunlight and is flammable.

Polystyrene foams are relatively inexpensive compared to polyurethane. They can be purchased in large quantities and cut to shape. Polystyrene foams are used in decks for buoyancy of small boat moorings in marinas.

Closed cell cross-linked polyethylene foams are used in foam-filled fenders. The foam, encased in an elastomer cover, absorbs the impact energy of berthing ships. Ionomer foams have been used in buoys and fenders. The outer skin of the products is a denser version of the low-density encased foam.

**3-6.4 Rubber and Elastomers.** Numerous natural and synthetic rubbers and elastomers are used at the waterfront in hose lines, gaskets, fender system components, and other specialized applications. These materials are resistant to the marine environment provided the appropriate rubber or elastomer is used. The more common material is a urethane elastomer as used for the shell of foam-filled fenders. The elastomer ethylene propylene dimonomer (EPDM) is used in arch-type rubber fenders.

**3-6.5 Other Synthetic Materials.** Synthetic materials are also used at the waterfront for pile wraps, piping, and as adhesives. Pile wraps are made of



flexible polyvinyl chloride (PVC) or polyethylene (PE) films and prevent growth of wood boring organisms. PVC piping is widely used for numerous applications, as it is lightweight and corrosion resistant. Some degradation of the piping will occur if exposed to sunlight and other weathering factors. Normally, PVC pipe becomes brittle as it ages.

Adhesives, coatings, and putties made from epoxy have been developed for bonding to damp and underwater surfaces. They are used to bond structures or components, connections, joints, and other metal configurations susceptible to corrosion; to fill voids; and to protect surfaces. They can also be used to patch holes above the water or underwater.

**3-7 SOIL FILL FOR QUAYWALLS AND MOLES.** Soil is the most common backfill material behind quaywalls, shoreline walls, and solid fill/mole piers; dikes; and levees. Refer to \1\ UFC 3-220-10N, , *Soil Mechanics*, and UFC 3-220-01N, *Geotechnical Engineering Procedures for Foundation Design of Buildings and Structures /1/* for further information on geotechnical issues.

**3.7.1 Description.** A complete description of a soil includes classification, density, shear strength, moisture content, and mineralogic content. For soils used in waterfront structures, it is often sufficient to classify them according to size (clay, silt, sand, and gravel.) The density, plasticity, and moisture content are important for the finer-grained soils, while soundness and gradation are applicable to the coarser-grained soils and rock fills.

The particle size, which marks the boundary between the fine-grained, generally cohesive soils (silts and clays) and the coarse-grained, granular soils (sands and gravels), is approximately the minimum size retained on the No. 200 standard sieve. Organic soils, such as elastic silts and peats, are never used in the construction or repair of engineering structures.

Maintenance problems increase as the grain size of the soil gets smaller. Finer-grained soils in the cohesionless range are extremely susceptible to leaching and erosion, whereas fine-grained cohesive soils are difficult to compact satisfactorily and may undergo undesirable shrinkage or swelling.

With granular soils, gradation is important. Uniformly graded soils with a narrow range of particle sizes are difficult to compact, are extremely porous, and have lower densities and strengths than soils with a broader distribution of particle sizes. However, where compaction of sands and gravels is involved, large, oversize cobbles can interfere with the compaction of the finer materials present. Such large particles should be removed from the compacted fills and used as riprap or slope protection.

*This page intentionally left blank.*

## CHAPTER 4

### SAFETY AND ENVIRONMENTAL COMPLIANCE

4-1           **INTRODUCTION.** Diverse types of work are performed at the waterfront during maintenance and repair of facilities. Much of this work contains elements hazardous to personnel, equipment, and property, as well as to the environment. The purpose of this chapter is to familiarize the reader with the areas of safety and environment that must be addressed during the planning and execution of waterfront maintenance or repair projects.

This section is divided into two topics: Occupational Safety and Environmental Compliance. Responsibility for safety and environmental compliance lies with each individual during each phase of a maintenance and repair project. However, all safety and environmental issues must be considered during the planning stage and be adequately relayed to the work site employees through training and consultation by the appropriate work supervisor.

There are many references to safety and environmental compliance that can be applied to waterfront construction and operations. Several primary military references are:

- OPNAVINST 5100.23, *Navy Occupational Safety and Health Program Manual*, U. S. Department of the Navy Instruction.
- OPNAVINST 5090.1, *Environmental and Natural Resources Program Manual*, U. S. Department of the Navy Instruction.
- COE EM 385-1-1, *Safety and Health Requirements Manual*, U.S. Army Corps of Engineers Manual.
- AFD 91-3, *Occupational Safety and Health*, U. S. Department of the Air Force Publications Document.
- 29 CFR 1910, *Occupational Safety and Health Standards for General Industry*
- 20 CFR 1915, *Occupational Safety and Health Standards for Shipyard Employment*
- 29 CFR 1917, *Occupational Safety and Health Standards for Marine Terminals*
- 29 CFR 1926, *Occupational Safety and Health Standards for Construction*

- NAVFAC P-307, *Management of Weight Handling Equipment Maintenance and Certification*.

4-2           **OCCUPATIONAL SAFETY.** At each Navy installation, a Safety Office exists to oversee all base operations for compliance with federal, state, and local occupational safety regulations. The Safety Office is the primary point of contact for information and assistance with project safety issues. It is their responsibility to give direction and guidance on what safety regulations are applicable for each project, and which safety measures are required for compliance. To adequately identify the hazards associated with this type of work operation, the Safety Office may require a safety plan for any new project. The safety plan is sometimes called an “accident prevention plan” or “job hazard analysis” and includes activity hazard analyses for each phase of the project. This plan identifies the sequence of work operations, hazards associated with each task and the recommended controls (engineering, elimination, isolation, substitution and/or personal protective equipment) to ensure safe work operations. This plan is submitted by the project planner(s) before the project begins. COE EM-385-1-1 recommends submitting the safety plan at least 15 calendar days before the work starts at the job site. However, individual Safety Offices may require longer review periods. The Safety Office reviews the plan and provides feedback to the project planner on safety requirements. Appendix A of \1\ USACOE EM-385-1-1 /1/ provides a minimum basic outline for Accident Prevention Plans. An example of a safety plan format is given in Figure 4-1. Project work for a new project is usually not allowed to proceed until the safety plan has been signed and approved.

Figure 4-1 Safety Plan Format

1. Proposed Project: \_\_\_\_\_
  - a) Description: \_\_\_\_\_  
\_\_\_\_\_
  - b) Project Site/Diagrams: \_\_\_\_\_
  - c) Dates/Times of Operation: \_\_\_\_\_
  - d) Project Personnel: \_\_\_\_\_
  - e) Safety Coordinators: \_\_\_\_\_
2. Preliminary Hazard Analysis:
  - a) List hazards, triggering events, and estimate seriousness: \_\_\_\_\_  
\_\_\_\_\_
  - b) Assign Risk Assessment Code (based on hazard severity and mishap probability): \_\_\_\_\_
  - c) Hazard Control Mechanisms/Safety Measures (attach SOPs): \_\_\_\_\_  
\_\_\_\_\_
3. Training and Medical Surveillance (list project personnel, their training, medical surveillance dates and signatures): \_\_\_\_\_  
\_\_\_\_\_
4. Hazardous Waste Operations and Emergency Response (describe applicable HW operations and emergency plans): \_\_\_\_\_  
\_\_\_\_\_
5. Personal Protective Equipment (list all PPE to be used for each task): \_\_\_\_\_  
\_\_\_\_\_
6. Medical surveillance (list personnel who have had the required medical surveillance exams for each task): \_\_\_\_\_  
\_\_\_\_\_
7. Industrial hygiene (identify requirements for air, personnel and environmental monitoring): \_\_\_\_\_  
\_\_\_\_\_
8. Site control measures (identify any site control measures instituted): \_\_\_\_\_  
\_\_\_\_\_
9. General information: \_\_\_\_\_
10. Phone contacts: \_\_\_\_\_
11. Emergency contacts: \_\_\_\_\_

4-3      **ENVIRONMENTAL COMPLIANCE.** Environmental compliance is a facility's or project's status with respect to a wide variety of federal, state, and local environmental regulations in existence to protect our environment. Environmental compliance involves aspects that affect the operation of a project, such as:

- Wastewater discharge
- Noise abatement
- Air quality attainment
- Hazardous waste (HW) and hazardous materials (HAZMAT) management

4-3.1    **Environmental Regulations.** Environmental regulations have increased exponentially in recent years due to a growing concern about the environment. All shore activities are now regulated by a number of federal, state, regional, and local agencies. Thus, compliance to all of the applicable regulations for a particular project can vary greatly depending on the project's nature and location.

Navy policies on environmental compliance are contained in OPNAVINST 5090.1. Although this instruction generally addresses the responsibilities of the facility's Commanding Officer and higher agencies, it should be reviewed for general policy and reference by all project personnel. OPNAVINST 5090.1 contains information on specific environmental topics including:

- Management of ozone-depleting substances
- Clean air ashore
- Clean water ashore
- Drinking water and water conservation
- Oil and hazardous substances contingency planning
- PCB management
- Pesticide compliance
- Noise prevention
- Installation restoration

- Natural resources management
- Solid waste management

4-3.1.1 **Other Services Documents.** The equivalent Army document is Army Regulation AR 200-1, *Environmental Protection and Enhancement*. The Air Force equivalent is the Air Force 32 Series instructions.

4-3.1.2 **Environmental Instructions.** In addition, most commands and activities have developed instructions that provide policy guidance for complying with regulatory requirements applicable to activity personnel. Consult with the Environmental Office to obtain relevant guidelines for that activity.

4-3.1.2.1 **Environmental Compliance Responsibility.** Environmental compliance is everyone's responsibility, from the Commanding Officer of the activity to the people performing the actual tasks of a project. The Department of Defense is fully committed to strict compliance, not only to protect our environment and conserve our natural resources, but also for the overall benefit to the mission or project. In the long run, proper compliance prevents time delays and operational shutdowns, and improves public relations.

4-3.1.2.2 **Environmental Office.** Depending on the reader's role in a waterfront maintenance and repair project, whether a planner or estimator, or a member of the activity requesting waterfront maintenance and repair, involvement with environmental documentation will vary. In all cases, however, each activity should have an Environmental Office that is responsible for overseeing the environmental aspects of all projects at that facility. Environmental Office personnel are responsible for: developing and implementing activity instructions and providing guidance on procedures for ensuring environmental compliance for projects. Specific services provided by the Environmental Office include:

- Preparing categorical exclusions
- Obtaining any necessary local permits
- Issuing site-approvals
- Contacting \1\ local NAVFAC offices /1/ and contractors when an Environmental Assessment (EA) or Environmental Impact Statement (EIS) preparation is appropriate

The flow chart in Figure 4-2 shows a typical process of environmental documentation.

Figure 4-2 Environmental Documentation Process

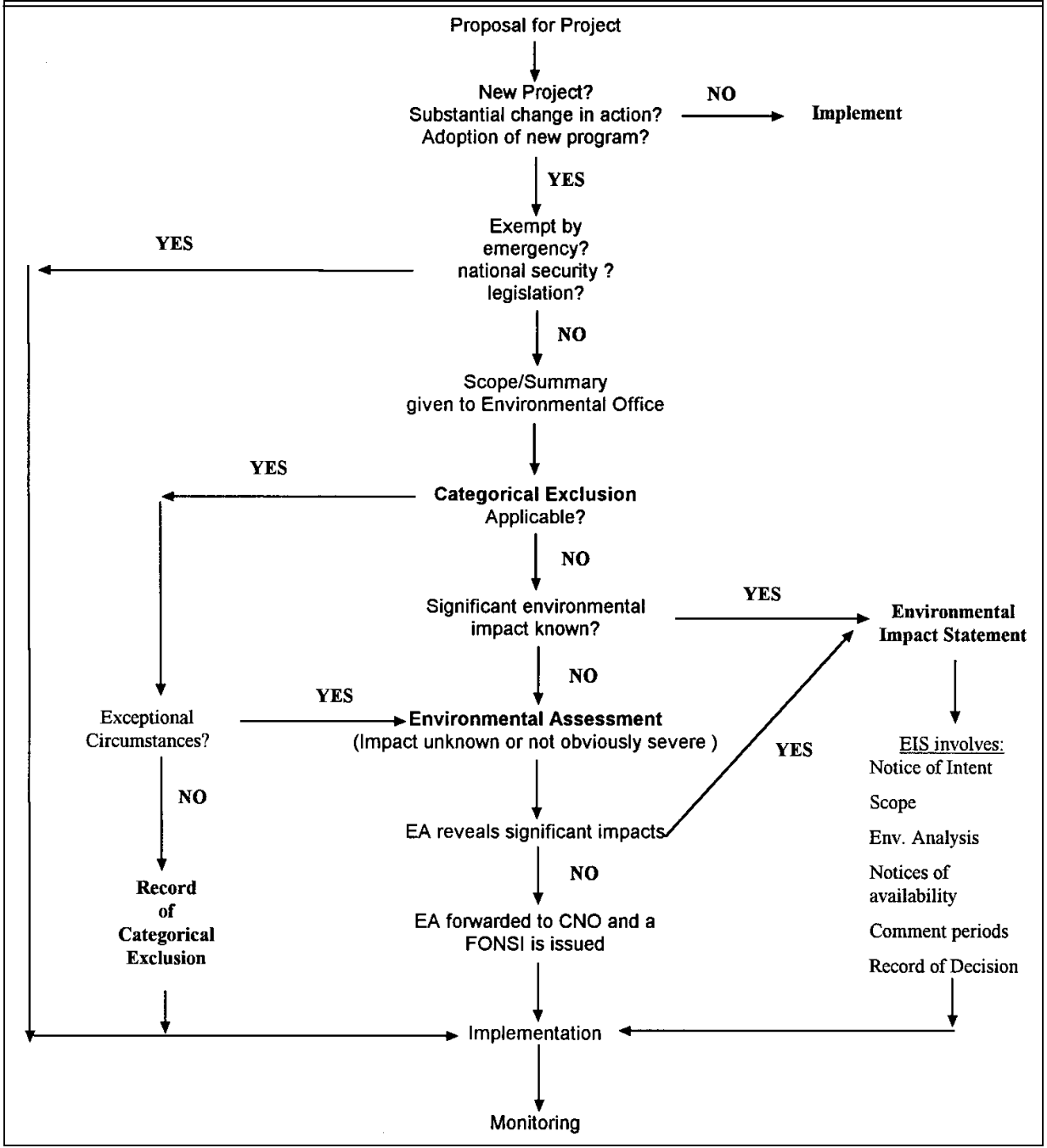



**4-3.1.3 National Environmental Policy Act (NEPA).** The National Environmental Policy Act (NEPA), first enacted in 1969, is the national charter (within the United States and its territories) for protection of the environment. It establishes policy, sets goals, and provides a means for carrying out environmental policy within the United States and its territories. NEPA impacts a wide variety of existing environmental legislation including the:

- Clean Water Act (CWA)
- Clean Air Act (CAA)
- Pollution Prevention Act (PPA)
- Coastal Zone Management Act (CZMA)
- Endangered Species Act (ESA)
- Marine Protection Research and Sanctuaries Act (MPRSA)

**4-3.2 Environmental Documentation.** Under the NEPA Council on Environmental Quality (CEQ), a three-tiered approach of environmental consideration and documentation has been established:

- Categorical Exclusion (Cat. Ex)
- Environmental Assessment (EA)
- Environmental Impact Statement (EIS)

**4-3.2.1 Categorical Exclusion.** A categorical exclusion is a statement that the intended project work or action does not have, under normal circumstances, individually or cumulatively, a significant effect on the environment. If a categorical exclusion is allowed, an EA or EIS will not be required. The Environmental Office is generally responsible for deciding on and preparing a categorical exclusion. To do this, the Environmental Office will require from the project coordinator or planner(s) a summary or scope of the work to be performed. This summary does not need to be a lengthy document but must contain sufficient detail of the work to allow the EO to determine whether a categorical exclusion is appropriate. Categorical exclusions include:

- Routine repair and maintenance of facilities and equipment to maintain existing operations and activities, including maintenance of improved and semi-improved grounds.

- Alteration and additions of existing structures to conform or provide conforming use specifically required by new or existing applicable regulations.
- Routine actions normally conducted to operate, protect, and maintain military-owned or controlled properties.
- New construction that is consistent with existing land use and, when completed, complies with existing regulatory requirements.
- Routine movement, handling, and distribution of materials, including HAZMAT or HW that is moved, handled, or distributed under applicable regulations.
- Demolition, disposal, or improvements involving buildings or structures neither on nor eligible for listing on the National Register of Historic Places.
- Actions which require the concurrence or approval of another Federal agency, where the action is a categorical exclusion of the other Federal agency.
- Maintenance dredging and debris disposal where no new depths are required, applicable permits are secured, and disposal will be at an approved site.

Even though a proposal generally fits the definition of a categorical exclusion, the categorical exclusion will not be used if the proposed action affects public health and safety, or involves an action that is determined to have the potential for significant environmental effects on wetlands, endangered species, HW sites, or archeological resources.

When it is unknown beforehand whether or not the proposed action will significantly affect the human environment or be controversial with respect to environmental effects, a categorical exclusion cannot be used.

**4-3-2.1.1 Environmental Office Documentation.** The Environmental Office must document the categorical exclusion(s), the facts supporting their use, and specific considerations of whether the exceptions to the use of categorical exclusions are applicable. This Record of Categorical Exclusion need not be more than a page or two, but must be signed by the Commanding Officer or a designee. The signed Record of Categorical Exclusion must be retained within the project files and be available for review during environmental compliance evaluations. Additionally, many Environmental Officers will prepare an Environmental Review Document (ERD), an in-house document listing impacts, or lack thereof, of the project on several environmental areas.

Even though a categorical exclusion is granted, it does not mean the end of the environmental compliance process. Local, regional, state, and federal agencies may require permits for certain operations, or for a specific type of equipment. It is the Environmental Officer's responsibility to obtain these permits, using the technical input from the project team. When work is contracted out, the contractor is responsible for providing an environmental protection plan, along with applicable permits and reports via the Contracting Officer.

4-3.2.1.2 **Permits.** Waterfront maintenance projects usually do not require permits unless special construction is required. Additionally, they will not need a new categorical exclusion if the work has been previously reviewed by the Environmental Officer. However, the Environmental Officer needs to be informed of any work taking place at the waterfront to ensure that environmental procedures are being followed. Normally, maintenance projects evolve from an annual inspection of waterfront structures by the Public Works Centers. The repair and/or maintenance requirements are then relayed to the facility customers who then submit a summary of the proposed work to the Environmental Office.

4-3.2.2 **Environmental Assessment.** An environmental assessment (EA) is an analysis of the potential environmental impact of a proposed action. An EA is prepared for projects or actions that do not fall under one or more of the listed categorical exclusions and that have the potential for significant environmental impacts. If significant impacts are obvious, an Environmental Impact Statement is directly prepared.

The EA discusses the need for the action, alternatives, impacts, and any environmental monitoring required. Additional information may be required of the project coordinators and other project planners to complete the EA. The EO will likely turn the preparation of an EA over to a local NAVFAC office or a contractor.

If after completion of the EA, it is determined that the proposed project will not significantly impact the environment, a Finding of No Significant Impact (FONSI) will be prepared and the project implemented. If it is determined that the proposed project will significantly impact the environment, an EIS must be prepared.

4-3.2.3 **Environmental Impact Statement.** An EIS is a detailed document that provides a full discussion of significant environmental impacts and informs decision makers and the public of reasonable alternatives that would avoid or minimize adverse impact, or enhance the quality of the human environment. EIS can be lengthy and are frequently prepared by contractors who can provide an unbiased analysis, thus avoiding a conflict of interest. An EIS is completed with a Record of Decision (ROD) and signed by the Secretary of the Navy. The

likelihood that an EIS would be required for a normal waterfront maintenance/repair project is small.

4-3.3 **Working in Compliance.** Once all permits for a project have been obtained and all documentation has been completed, the Environmental Officer will issue a “site-approval.” Generally, the Public Works Center performing the maintenance or repair will not start work until the site-approval has been issued.

Often, contact with the activity’s Environmental Office during planning and execution of waterfront maintenance and repair projects is all that will be required to assure compliance with environmental regulations. Project personnel in some circumstances, however, may need to establish direct contact with the various permitting and regulatory agencies concerned with the work. These might include but are not limited to:

- Port officials
- State Department of Health
- Department of Fish & Game
- State EPA office
- Coast Guard
- Army Corps of Engineers

Contact with these agencies should not be used to circumvent communication with the Environmental Office, but should be used to compliment it to help ensure environmental compliance and agency approval of the planned project tasks.

4-3.4 **Environmental Training.** All project personnel should be provided with formal training on the principles of environmental compliance and the regulations that govern them. Personnel working on projects that involve hazardous materials and wastes, operations which potentially could cause air, water, or noise pollution, or that may endanger the marine environment need more extensive training in these specific areas. OPNAVINST 5100.23 gives Navy requirements for training for hazardous materials handling and hazard communication.

The primary source of information concerning environmental training requirements is, again, the Environmental Office. They provide guidance on who must be trained, what training is required, and how often. They frequently conduct the training sessions themselves.

4-3.5 **Treated Wood - Environmental Issues.** Since there is extensive use of treated wood at waterfront facilities, and since wood preservatives likely constitute the greatest percentage of chemicals used on the waterfront, a special mention about the environmental issues is warranted. In recent years, using treated wood in the marine environment raised concerns about its effect on surrounding aquatic life. Currently, wood preservatives are registered by the EPA for use in the marine environment, and treated wood is not considered a hazardous waste nor banned from landfills, according to Federal law. However, local and state regulations are more restrictive. The Environmental Office should be consulted for applicable restrictions at the waterfront facility of interest. See Chapter 6 of this handbook for more information on the environmental concerns of treated wood.

*This page intentionally left blank.*

## CHAPTER 5

### INSPECTION

5-1 **GENERAL CONSIDERATIONS.** The fundamental purpose of any inspection is to provide the information necessary to assess the condition (capacity, safety, and rate of deterioration) of a structure. Waterfront structures to be inspected include: piers, pilings, wharves, quaywalls, fender systems, dolphins, and drydocks.

5-1.1 **Inspection Objectives.** Inspections are classified according to the objectives. These include:

- Baseline - to obtain data on a facility that has not been inspected. This inspection involves the greatest “pre-inspection” effort.
- Routine - to obtain data on general condition, confirm drawings, estimate repair costs, etc.
- Design Survey - to obtain data for specifications or for detailed cost estimates.
- Acceptance - to obtain data confirming that a repair has been completed according to plan or specification.
- Research - to obtain data on deterioration rates, etc.

The usefulness of an inspection depends on establishing a clear and complete record. Although the level of inspection will determine the extent of information to be provided, in general the inspection will address the:

- Identification and description of all major damage and deterioration of the facility.
- Description of facilities inspected including updated layouts of pile plans (which occasionally differ significantly from the drawings available at the activity).
- Documentation of types and extent of marine growth, if applicable.
- Water depth, visibility, tidal range, and water current.
- Assessment of general physical condition including projected load capacities.
- Recommendations for required maintenance and repair (M&R).

- Budgetary estimates of costs of this M&R, including examples of how estimates were derived.
- Identification of any problems associated with mobilization of equipment, personnel, and materials to accomplish repairs/maintenance.
- Estimate of expected life of each facility.
- Recommendations for types and frequencies of future underwater inspections.

5-1.2 **Information an Inspection Should Provide.** There are a number of reference documents dealing with waterfront inspections. The inspection procedures and planning factors outlined in this section have been taken from several of them. Two important references are:

\1\

- NAVFAC MO-322, *Inspection of Shore Facilities*
- NTRP 4-04.2.8, *Conventional Underwater Construction and Repair Techniques*
- NTRP 4-04.2.9, *Expedient Underwater Construction and Repair Techniques*

/1/

5-2 **LEVELS OF INSPECTION.** For any inspection objective, three levels of inspection effort are used for inspecting waterfront facilities:

5-2.1 **Level I - General Visual Inspection.** This inspection involves no cleaning of any structural elements and, therefore, is the most rapid of the three types of inspection. The purpose of the Level I inspection is to confirm as-built structural plans, provide initial input for an inspection strategy, and detect obvious major damage or deterioration due to overstress, impacts, severe corrosion, or extensive biological growth and attack.

5-2.2 **Level II - Close-Up Visual Inspection.** This inspection is directed toward detecting and identifying damaged or deteriorated areas that may be hidden by surface biofouling or deterioration and obtaining a limited amount of deterioration measurements. The data obtained should help estimate the facility's load capability. Level II inspections will often require cleaning the structural elements. Since cleaning is time consuming, it is generally restricted to areas that are critical or which may be representative of the entire structure. The



amount and thoroughness of cleaning to be done is governed by what is necessary to determine the general condition of the overall facility.

5-2.3 **Level III - Highly Detailed Inspection.** It is recommended that a “Level III” above and under water inspection be performed on piers identified for mooring use during heavy weather conditions. This inspection normally includes underwater inspections, and will often require the use of nondestructive testing (NDT) techniques. It may also require using partially destructive techniques, such as core sampling of concrete and wood structures, physical material sampling, or surface hardness testing. The purpose of this type of inspection is to detect hidden or interior damage, loss in cross-sectional area, and material homogeneity. A Level III examination will normally require cleaning. The use of NDT techniques are usually limited to key structural areas, areas that may be suspect, or structural members that may be representative of the underwater structure. Level III inspections require more experience and training than Level I or Level II inspections, and should be done by qualified engineering or nondestructive testing personnel. This type of inspection is covered in MO-104.2.

Inspection of waterfront facilities is considered to be a specialized control inspection within the Navy. The underwater inspection should be done by a qualified, certified diver supervised by an engineer or a qualified engineering diver. The structural assessment must be done by an engineer with experience and skill in inspection procedures and techniques.

Table 5-1 lists the types of damage that are detectable with the three levels of inspection.

5-3 **PLANNING FOR INSPECTION.** The levels of inspection to be used for a particular task must be decided early in the planning phase. The inspection objectives (i.e., baseline, design survey, repair acceptance, research) should be clearly defined. A site survey of the facilities should be obtained, or conducted if doing a first-time inspection. A site survey for underwater inspections includes: bathymetric, oceanographic, and geological data, as well as information on nearby obstructions or activities. A site survey accelerates the planning process and will help determine the levels of inspection to be used.

The time and effort required to carry out the three different levels of inspection are quite different. The time required also depends on whether the inspection is surface or underwater; on environmental factors, such as visibility, currents, wave action, water depth, tides, severity of marine growth; and on the inspector’s skill and experience.

**Table 5-1. Capability of Each Level of Inspection for Detecting Damage to Waterfront Structures**

Level	Purpose	Detectable Defects		
		Steel	Concrete	Wood
I	General visual to confirm as-built conditions and detect severe damage	<p>Extensive corrosion</p> <p>Severe mechanical damage</p>	<p>Major spalling and cracking</p> <p>Severe reinforcement corrosion</p> <p>Broken piles</p>	<p>Major losses of wood due to marine borers \1\ (limnoria; see earlier section on Marine Borers) /1/</p> <p>Broken piles and braces</p> <p>Severe abrasion or marine borer attack</p>
II	Detect surface defects normally obscured by marine growth	<p>Moderate mechanical damage</p> <p>Major pitting</p>	<p>Surface cracking and crumbling</p> <p>Rust staining</p> <p>Exposed rebar and/or pre-stressed strands</p>	<p>External pile diameter reduction due to marine borers</p> <p>Splintered piling</p> <p>Loss of bolts and fasteners</p> <p>Early borer and insect infestation</p>
III	Detect hidden and imminent damage	<p>Reduced thick-ness of material</p>	<p>Location of rebar</p> <p>Beginning corrosion of rebar</p> <p>Internal voids</p>	<p>Internal damage due to marine borers,\1\ internal voids (teredines and pholads; see earlier section on Marine Borers) /1/</p> <p>Decrease in material strength \1\ (based upon section loss as determined by either nondestructive and/or destructive testing which are discussed in this chapter) /1/</p>

Table 5-2 provides a guide for estimating the time required to conduct Level I and Level II surface and underwater inspections.

Level III inspections depend on the extent of existing damage, the type of inspection techniques, and the equipment used (ultrasonic thickness measurements, increment borings, caliper measurements). Therefore, estimates of time for Level III inspection are not included in Table 5-2.

Table 5-3 shows daily rates for underwater inspection of piles and bulkheads.

**Table 5-2 Production Rate for Surface and Underwater Inspection of Structural Elements**

Structural Element	Inspection time per Structural Element (minutes)			
	Level I		Level II	
	Surface	Underwater	Surface	Underwater
12 inch (30 cm) steel H-pile	2	5	15	30
12 inch (30 cm) wide strip of steel sheet pile	1	3	8	15
12 inch (30 cm) square concrete pile	2	4	12	25
12 inch (30 cm) wide strip of concrete sheet pile	1	3	8	15
12 inch (30 cm) diameter timber pile	2	4	10	20
12 inch (30 cm) wide strip of timber sheet pile	1	3	7	15

NOTE: This information is based on a 11 to 15 yard r (10 to 14 meter) water depth; 3.1 to 6.6 feet (1 to 2 meter) visibility; warm, calm water; moderate marine growth about 2 inch (5 cm) thick; and an experienced engineering diver or diver supervised by an engineer. For the Level II inspection, it is assumed that 3.1 feet (1 meter) of the structural element is in the splash zone, 12 inch (30 cm) at mid-depth, and 12 inch (30 cm) at the bottom, and will be completely cleaned of marine growth. It is also assumed that the most efficient method of removing marine growth will be used.

**Table 5-3. Daily Rates for Underwater Inspection Tasks\***

Inspection Task	Pile/Day	Bulkhead in Linear Meters Day
Swim by	300 to 600	150 to 450
Cleaning	30 to 70 at 3 to 15% of each pile	150 to 450 at 15 to 90meter (16 to 98 yard) intervals
Measurements	50 to 200 for wood at 5 to 15% of each pile  30 to 60 for steel at 3 to 10% of each pile  30 to 70 for concrete at 3 to 15% of each pile	150 to 450 at 15 to 90meter (16 to 98 yard) intervals

\*Rates vary widely depending on the effects of many factors, such as: water visibility, facility size and age, marine growth, and construction.

5-3.1 **Inspection Frequency.** The frequency of routine or periodic inspections will depend on whether the inspection is on the surface or underwater, and the expected rate of deterioration and damage. An example of an area requiring more inspections is ships berthing, which deteriorates both fender and bearing piling. The frequency and level of inspection should, therefore, be closely tied to the historical deterioration rate of the facility. Statistical software has been developed that identifies inspection frequencies based on cost when known or estimated structural data. The frequencies obtained will be unique to the activity's situation (from NCEL CR 87-005, *Inspection Frequency Criteria Models for Timber, Steel, and Concrete Pile Supported Waterfront Structures*, December 1986.) As a general guide, recommended frequencies of inspection for the different types of waterfront structures are:

Figure 5-1. Exposure zones on piling.

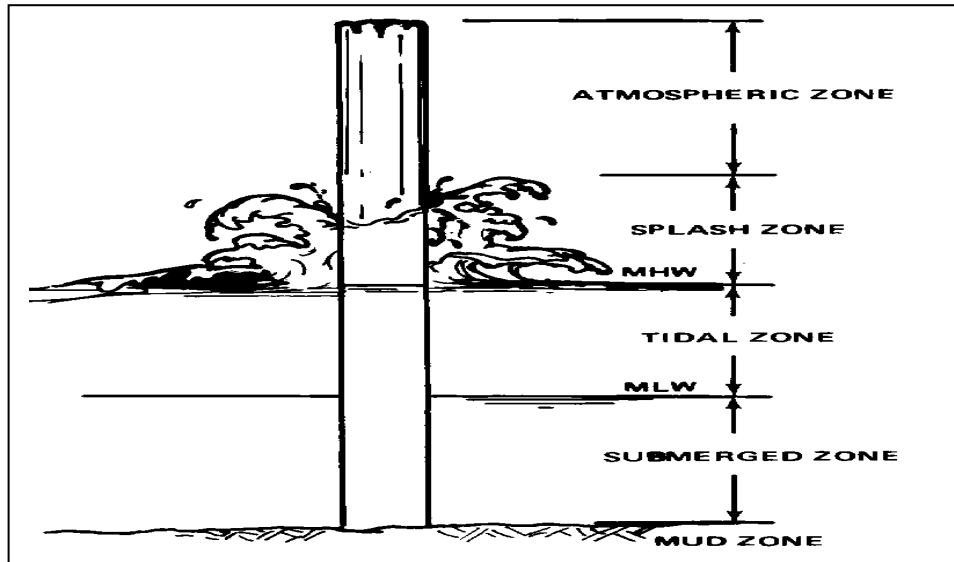

- a. All superstructure and piling/sheet piling above the waterline, including the splash and tidal zones (Figure 5-1), should be inspected annually.
- b. Concrete/steel structural members at the splash/tidal zones (Figure 5-1) and downward should be inspected at least every 6 years. As deterioration is discovered, the level of inspection and frequency needs to increase accordingly. For steel structures, the age of the structures is a primary factor since the rate of deterioration due to corrosion is fairly constant. Likewise, concrete in a saltwater environment deteriorates chemically with time, especially if cracks are present to allow the seawater to reach the structure's interior.
- c. Timber members should be inspected at least every 3 years and, as above, more frequently and intently as deterioration is discovered. In areas where marine animal infestation is known to be a problem, increased inspections are especially important.

If it is not feasible to thoroughly inspect all elements of a structure (e.g., underwater inspection of a series of piers with many piles), selecting an optimum number of structural elements or members is crucial to obtaining accurate information representative of the overall condition of the structure. Development and validation of sampling criteria and procedures has been reported in Naval Civil Engineering Laboratory's TN-1762 *Sampling Criteria and Procedures for Inspection of Waterfront Facilities*, September 1988. Statistical sampling techniques using probability theory provide a method for determining condition

parameters for the entire population based on information from the sample elements, with a calculated confidence level and precision.

5-3.2 **Inspectors.** Inspections may be by a variety of individuals at different times for different reasons. It should be noted that periodic comprehensive inspections are done as part of the Underwater Inspection Program administered by the \1\ Naval Facilities Engineering Service Center, East Coast Detachment.  
/1/

5-3.3 **Collecting Inspection Plan Data.** Before starting an inspection, all available information about the facility should be gathered. This includes prior maintenance and inspection records, facility drawings and site survey reports, general background information, and environmental data, including:

- Atmospheric temperature range
- Water temperature range
- Tidal range
- Water depths
- Water visibility
- Currents

Any condition could have a direct impact on the time required to perform an inspection, such as: the amount of biofouling growth on piles; ice; or seasonal flooding. Any other unique feature or special problems that may be encountered should also be noted.

The inspection plan should include CADD drawings showing individual piles and other structural members. The inspection could use pile numbering/designation systems often available on existing "as-built" drawings. Usually, combinations of numbers and letters are used with the number designating the bent and letter indicating the pile within the bent. CADD drawings should also be developed for the above and below deck portions of the pier. The existing positions of all topside bollards, bits, cleats, capstans, utility covers, as well as any under deck utilities and fittings should be shown on the CADD drawings. A legend should be created to represent such things as the:

- Degree of deterioration of individual structural members
- Level of inspection given to designated portions of a facility
- Shape of individual piles

- Type of materials
- Condition of bollards and bitts

Pile plans should be prepared for piers showing the lengths, widths, and spacing of bents. The plans must also include the numbering system used in the inspection and in the report, and these must be correlated with existing drawings of the facility. Also include design live load data on all pile plans, if available. Load testing of the pier decking, if heavy equipment or vehicles are driven onto the pier, should be considered.

Particular attention should be paid to mooring hardware as it relates to safe mooring of naval vessels during heavy weather. A more thorough treatment of this topic is contained in \1\ UFC 4-150-08, *Inspection of Mooring Hardware*. /1/

**5-3.3.1 Developing Inspection Plan.** Once the information about the facility structure and environment has been collected, an inspection plan is developed. The plan should be based on the inspection objective and the level of inspection required to meet that objective. It is important to select enough inspection areas per structural member. The written plan should be similar to a statement of work (SOW) specifying the sampling criteria, tasks, schedules, equipment to be used, and any additional responsibilities. The inspection plan must be prepared by a qualified engineer who is familiar with the structure.

The plan must specify that a qualified diver supervised by a qualified engineering diver should conduct the underwater inspections and an experienced engineer must perform the structural assessment of the entire pier.

#### 5-3.4 Equipment and Tools

**5-3.4.1 Surface Cleaning Tools.** To perform a Level II and Level III inspection, the marine growth on the structure must be removed. How this is done depends on the surface support available. For small sample areas, wire brushes, probes, and scrapers may be adequate. For larger areas or more detailed inspections underwater, a hydraulic grinder with barnacle buster attachment, or high-pressure water jet gun, may be used. Take care to prevent damage to pile wraps or coatings and to the preservative-treated layers of timber or deteriorating surfaces of concrete.

**5-3.4.2 Inspection Tools.** Inspection tools and equipment include:

##### 5-3.4.2.1 Hand-Held Tools.

- Portable flashlight, ruler, and tape measure for documenting areas

- Small or large hammers or pick-axes for performing soundings of the structural member
- Calipers and scales for determining thickness of steel flanges, webs, and plates, or diameters of piling
- Increment borer and T-handles for extracting core samples from timbers
- Chipping tools for prodding the surface of the concrete to determine the depth of deterioration.

5-3.4.2.2 **Mechanical Devices.** Mechanical devices including a Schmidt test hammer for measuring concrete surface hardness and rotary coring equipment for taking core samples from concrete structures.

5-3.4.2.3 **Electrical Equipment.** This includes electrical equipment, such as an underwater voltmeter for determining the level of cathodic protection on steel structures and underwater sonic and ultrasonic equipment for detecting voids in concrete and thickness of structural steel. It also includes underwater magnetic particle testing to locate and define surface discontinuities in magnetic materials. Figure 5-2 shows typical equipment applications used in underwater inspections.

5.3.4.3 **Recording Tools.** Recording tools and equipment are required to provide a complete documentation of the condition of the structure. Simple tools such as a clipboard, forms, and cassette recorder for above water inspections; or Plexiglas® slate and grease pencil for underwater inspection, provide the basic documentation tools. More in-depth documentation may be obtained with above water or underwater photography using either colored still-frame cameras, colored video, or closed-circuit television. The latter may be very valuable in expediting major underwater inspections. For underwater inspections in turbid water, a clear-water box may be fitted to the lens of the photographic or video equipment to improve visibility between the lens and surface to be inspected.

5-3.5 **Preparing Inspection Documentation.** For the information to be useful, documentation must be clear and concise. Inspectors should maintain daily logs of inspection details including measurement data, locations of observation, and water depths, if relative. Fill out inspection forms as the inspection progresses, and complete the reports soon after the inspection has been finished. Standard forms and report formats facilitate the documentation procedure and are essential for comparing the results of the present inspection with past and future inspections. Figure 5-3 is a standard form that may be used for reporting the condition of piles; Figure 5-4 is an explanation of the condition ratings for concrete piles used on the form; and Figure 5-5 is an explanation of



the condition ratings for timber piles. Steel pile inspection results are usually recorded in terms of remaining metal thickness.

Figure 5-2 Tools and Equipment Used for Waterfront Inspection



Figure 5-3 Standard Pile Inspection Report Form.

PILE INSPECTION RECORD																
LOCATION										DATE				DIVERS		
PIER NAME/NO										PILE TYPE <input type="checkbox"/> BEARING <input type="checkbox"/> FENDER <input type="checkbox"/> SHEET			PILE MATERIAL <input type="checkbox"/> TIMBER <input type="checkbox"/> STEEL <input type="checkbox"/> REINFORCED CONCRETE			
WATER DEPTH					TIME OF DAY					TIDE			DEPTH OF DAMAGE FROM DATUM-GAUGE DEPTH-TIDE			
BENT NO	PILE NO	NI	PILE CONDITION					TYPE DAMAGE			GAUGE DEPTH DAMAGE	DIMENSIONS OF DAMAGE			COMMENTS	
			ND	MN	MD	MJ	SV	MECH	BIO	FUNC		HGT	WIDTH	PENETR		

Figure 5-4 Pile Condition Ratings for Concrete Piles





<b>CONCRETE PILES</b>	
<u>CONCRETE PILE CONDITION RATING</u>	<u>EXPLANATION</u>
	<p>NI NOT INSPECTED, INACCESSIBLE OR PASSED BY</p>
	<p>ND NO DEFECTS:                      - hairline cracks                      - good original surface, hard material</p>
	<p>MN MINOR DEFECTS:                      - good original surface                      - minor cracks or pits                      - small chips or popouts                      - slight rust stains                      - hard material, sound                      - corrosion of the wires</p>
	<p>MD MODERATE DEFECTS:                      - limited spalling of concrete                      - minor corrosion of exposed re-bar                      - rust stains along re-bar                      - softening of concrete                      - reinforcing steel ties exposed                      - popouts or impact damage</p>
	<p>MJ MAJOR DEFECTS:                      - spalling of concrete results in (10-15%) loss                      - large spalls six inches or more in width or length                      - deep wide cracks along re-bar                      - major rust stains along rebar                      - wide spread surface disintegration</p>
	<p>SV SEVERE DEFECTS:                      - exposed rebar with 50% loss of steel section area                      - more than 15% loss of concrete</p>
<p>NOTE: Explanation of defect should be placed in the comments column.</p>	

Figure 5-5 Pile Condition Ratings for Timber Piles

<u>TIMBER PILE</u>	
<u>CONDITION RATING</u>	<u>EXPLANATION</u>
NI	NOT INSPECTED, INACCESSIBLE OR PASSED BY
	<p>ND NO DEFECTS:</p> <ul style="list-style-type: none"> <li>- Less than 5% lost material</li> <li>- sound surface material</li> <li>- no evidence of borer damage</li> </ul>
	<p>MN MINOR DEFECTS:</p> <ul style="list-style-type: none"> <li>- 5% to 15% lost material</li> <li>- sound surface material</li> <li>- no evidence of borer damage</li> <li>- minor abrasion damage</li> </ul>
	<p>MD MODERATE DEFECTS:</p> <ul style="list-style-type: none"> <li>- 15% to 45% lost material</li> <li>- significant loss of outer shell material</li> <li>- evidence of borer damage</li> <li>- significant abrasion damage</li> </ul>
	<p>MJ MAJOR DEFECTS:</p> <ul style="list-style-type: none"> <li>- 45% to 75% lost material</li> <li>- significant loss of outer shell and interior material</li> <li>- evidence of severe borer damage</li> <li>- severe abrasion damage</li> </ul>
	<p>SV SEVERE DEFECTS:</p> <ul style="list-style-type: none"> <li>- more than 75% lost material</li> <li>- no remaining structural strength</li> <li>- severe borer damage</li> </ul>
	<p>NOTE: Explanation of defect should be entered in the comments column.</p>

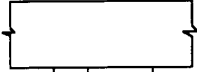
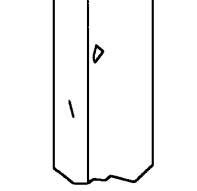
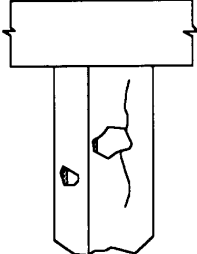
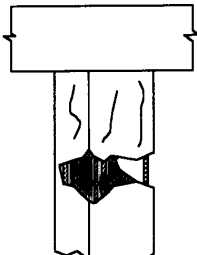
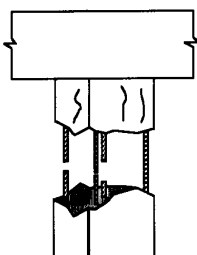
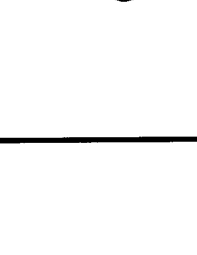
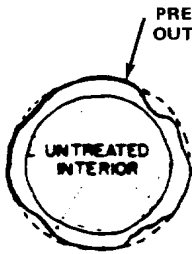
When appropriate, visual inspection should be documented with still photography and closed-circuit television. Still photography provides the necessary high definition required for detailed analysis, while video provides a continuous view of the inspection. All photographs should be numbered and labeled with a brief description of the subject. A slate or other designation identifying the subject should appear in the photograph. Video tapes should be provided with a title and lead-in describing what is on the tape. The description should include the inspection method used, the nature and size of the structure being inspected, and any other pertinent information.

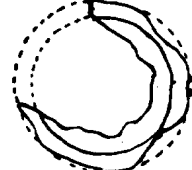
#### 5-4        **INSPECTION OF TIMBER STRUCTURES**

##### 5-4.1      **Scoping the Problem.** Timber damage is caused by:

- Fungal rot
- Marine borer and insect attack
- Shrinkage
- Overloading
- Connector Corrosion
- Abrasion
- Ice Lift

These are described in detail in Chapter 3. Typical damage found is illustrated in Figures 5-6, 5-7, 5-8, and 5-9.

Waterfront deterioration and damage is found by walking the pier, by inspecting dolphins and below pier decks in a small boat or barge, and by underwater inspections.

When inspecting above the water, the inspector should take maximum advantage of low tide conditions in order to visually inspect the overall condition of the piling. This may determine that an underwater inspection is necessary. The underwater inspection should, on the other hand, take advantage of high water conditions in order to compile the most comprehensive field data on existing conditions.

5-4.2      **Surface Inspections.** Use Figure 5-10, “Timber Structures and Attachments (Above Water) Checklist” to ensure that a thorough inspection of all timber structures and their attachments above water is done. Include annual load

testing of the pier decking if heavy equipment or vehicles are driven onto the pier. Sampling equipment and inspection data to be compiled are in Table 5-4.

Figure 5-6 Damage Areas Involving Timber Members

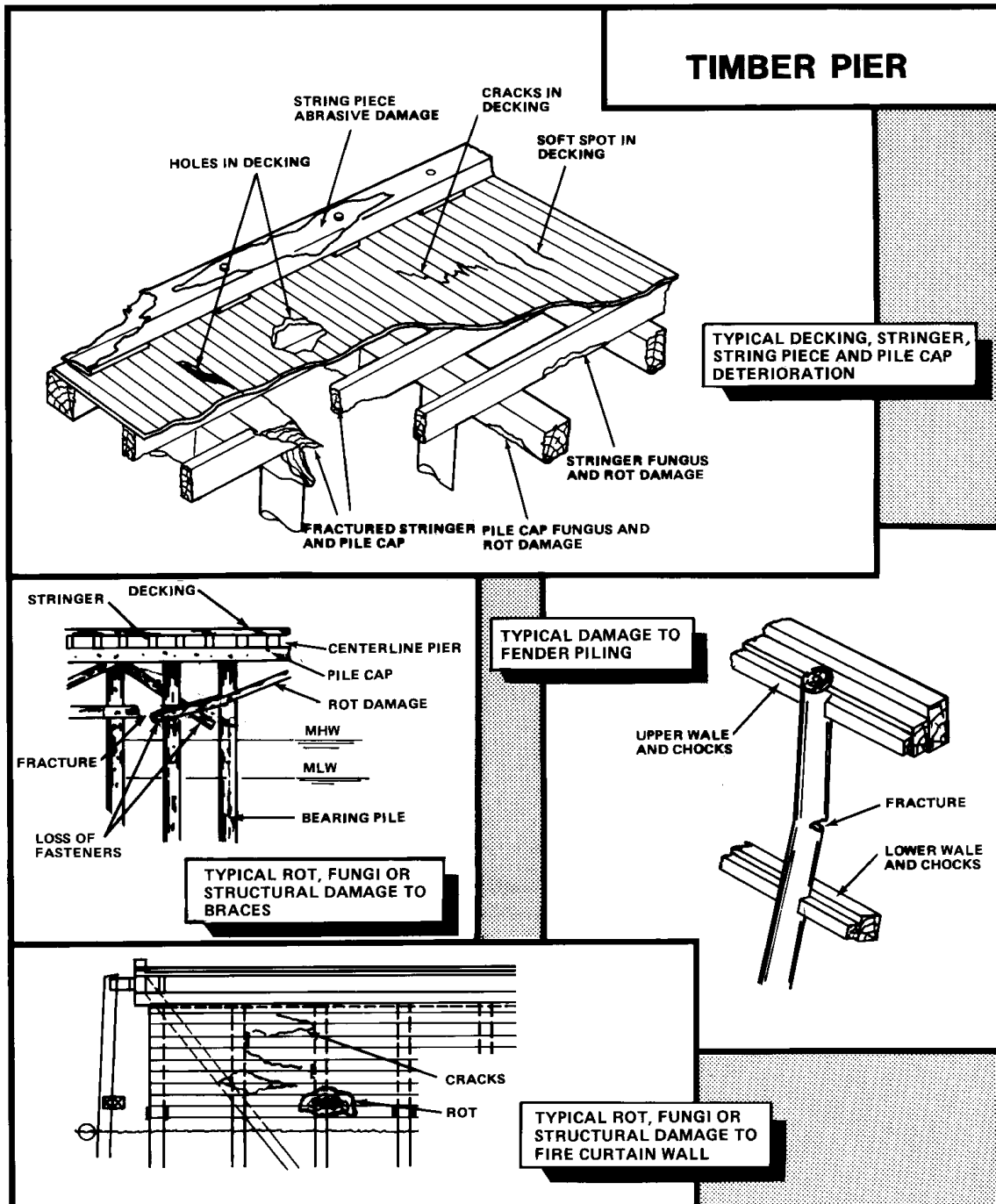

Figure 5-7 Damage to Timber Piles from Biological Sources

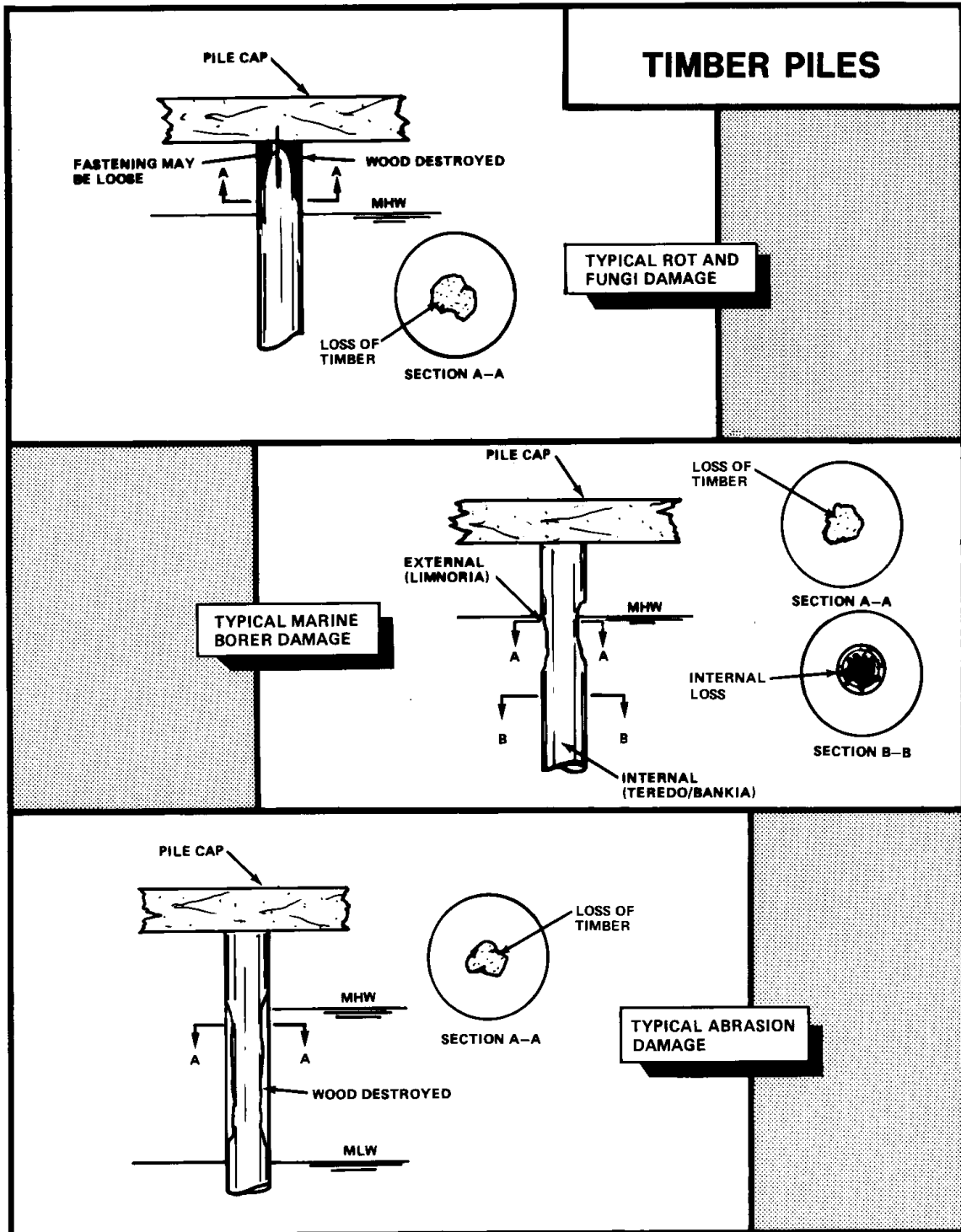

Figure 5-8 Damage to Timber Piles from Non-Biological Sources

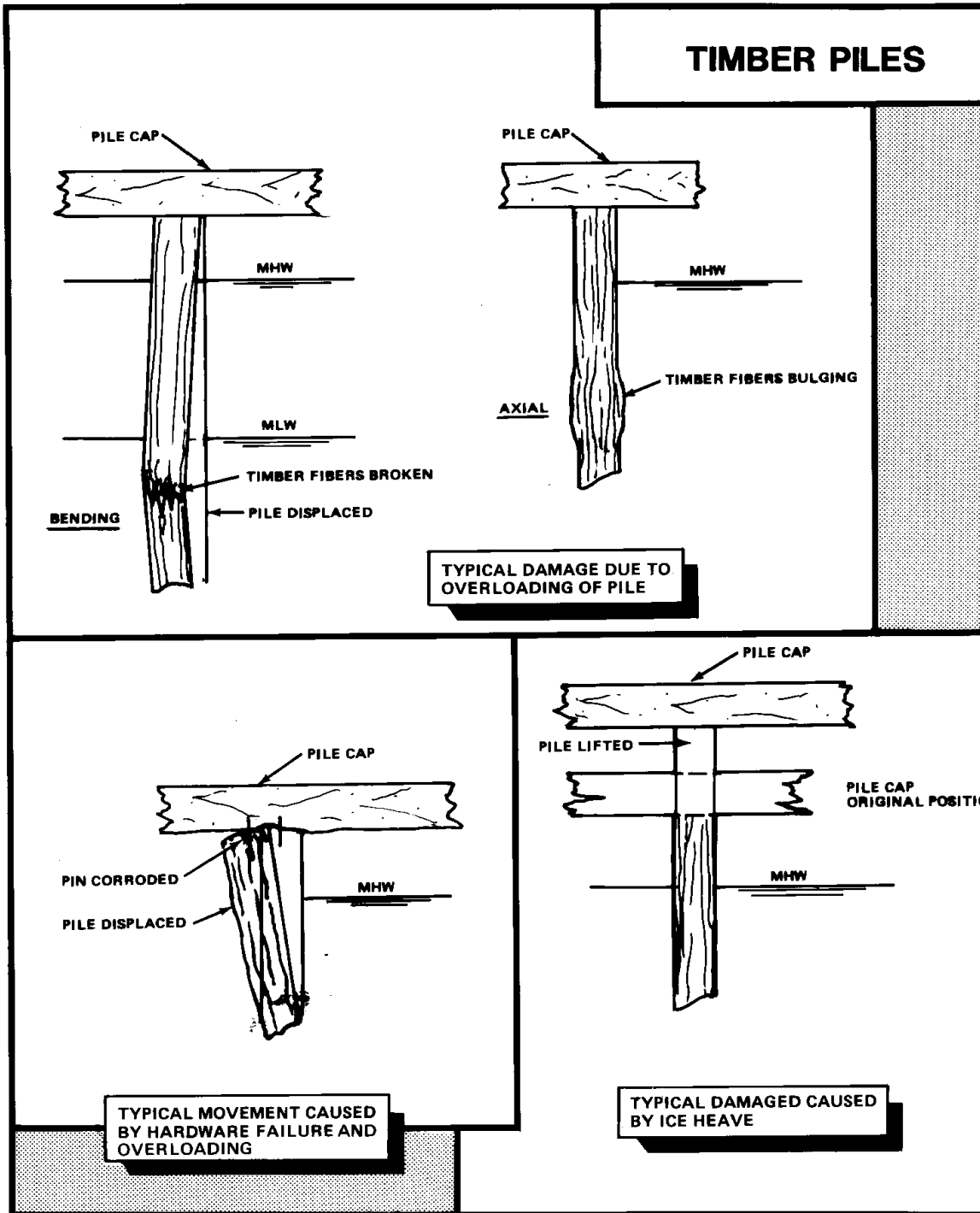
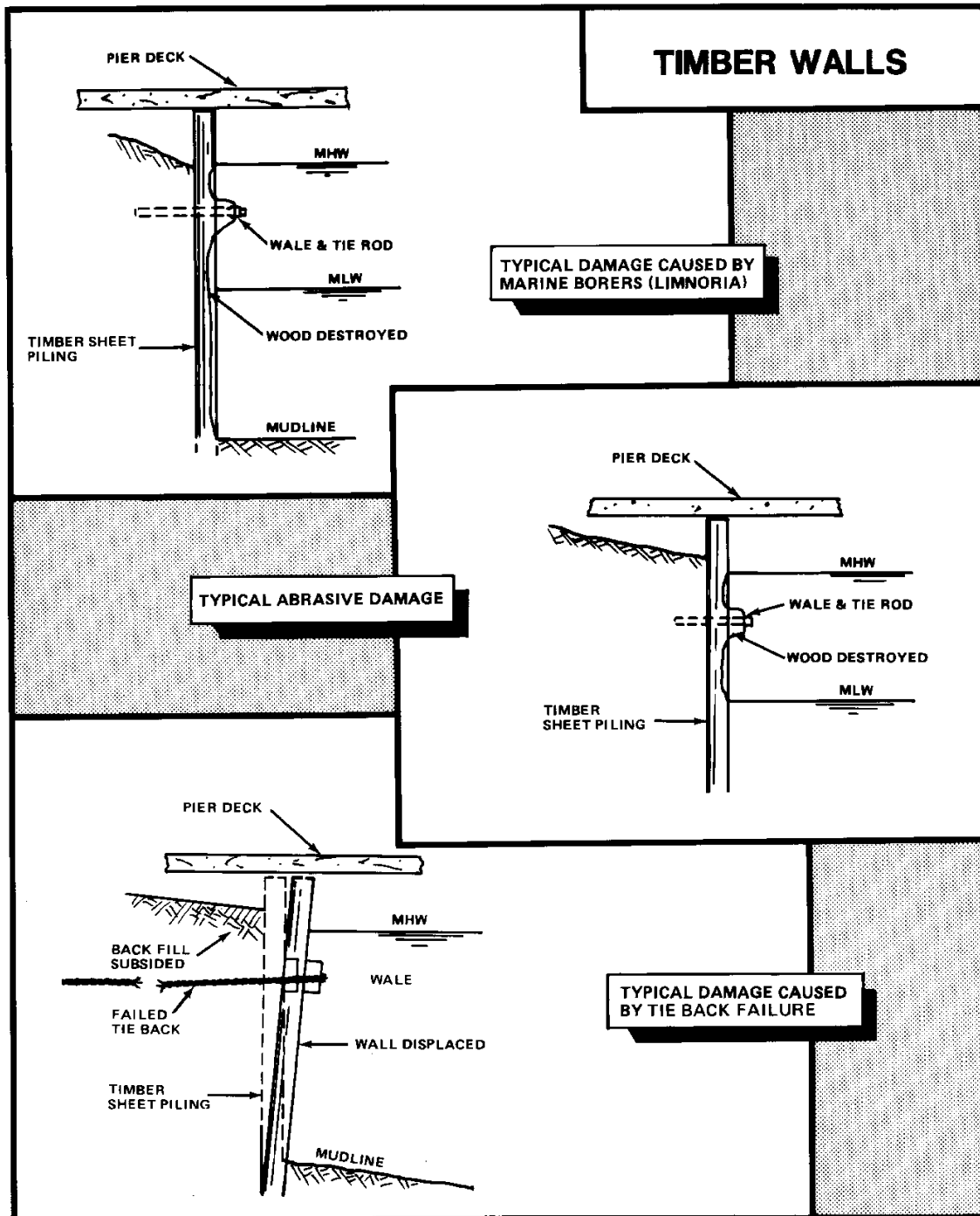



Figure 5-9 Damage to Timber Sheet Piling



The inspector should be alert, specifically in the areas of stringers, pile caps and top of piles, for signs of discoloration and softening of the wood, accompanied by a fluffy or cotton appearance. This may be an early sign of fungi damage. More advanced deterioration may take on the appearance of fruiting bodies, such as mushrooms. Further down the pile, the inspector should look for burrows or hollows in the wood, surface trenches in the outer layers of the pile, and loss of pile diameter. This may be evidence of marine borer attack.

**Table 5-4 Sampling Equipment, Measurements, and Ratings for Timber Structures**

Special Sampling Equipment	Measurements or Ratings
Increment borer (Install Treated wooden plugs in holes left after boring)	Quality of preservative or soundness of piling
Calipers	Pile diameter; rating of piling condition
Sonic Equipment	Data from sonic equipment; detection of hollow areas in piling
Ice pick or other sharp probe	Location and size of damaged areas  Depth of cracks and other damaged areas

**5-4.3 Underwater Inspection.** Use Figure 5-11 “Timber Structures and Attachments (Below Water) Checklist” to ensure that a thorough inspection of all timber structures and their attachments below water is done. An engineer should explain to the diver exactly what should be looked for: number and size of piles, type and depth of bulkheads, location of tiebacks, and cross bracing. The engineer shall evaluate the diver’s observations and determine the degree of hazard.

\1\

Additionally, when observing damage from marine borers (teredos) precautions need to be taken. As the diver swims up to the pile, he may be able to see the cilia, “waving,” as the worm filters food from the water, Otherwise, the worm feels the disturbance and withdraws the feeding hairs (and closes the opening). The diver is unable to see anything because the opening is:

- Small
- Closed
- Obscured by marine growth and shellfish

/1/

**Figure 5-10 Timber Structures and Attachments (Above Water) Checklist**

Deck Area	
___	Check for cracked, rotted, loose or worn decking or string pieces, loose hardware, soft spots in decking (Figure 5-6), and termite or pest infestations.
___	Check the tops of fender piles and visible chocks and wales for physical damage, dry rot and termite or pest infestations.
___	Check horizontal and vertical alignment.
___	Check for missing, broken, or loose connections; obstructions; and other hazardous conditions of curbing, handrails, and catwalks.
___	Check bollards, bits, cleats and capstans for wear, breaks, rough or sharp surfaces or edges and missing or loose bolts.
___	Check deck drains and scuppers for loose, missing or broken screws, standing water, and other deficiencies.
___	Check manhole covers and grating for rust, corrosion, bent or worn hinge pins, and other damage.
___	Inspect asphalt deck coverings (if applicable) for cracks, holes, and other damage.
___	Check ladders for rust and corrosion, broken, bent or missing rungs, and rot, termite or pest infestations.
___	Check grounding connections for tightness.
Exposed Area Under Pier or Along Wharf or Dolphin Assembly	
___	Check wood stringers, pile caps, bearing, batter and fender piles, for missing or broken members and evidence of fungal decay and insect damage. Check for loose, fractured or missing wales and chocks.
___	Check dolphins for broken, worn or corroded cables and cable connectors; and corroded, loose, broken or missing wedge block, chafing strips and bands, or chock bolt hangers.
___	Check dolphins for poor vertical pile alignment.
___	Visually examine piling and other wood in the splash and tidal zones for marine borer damage.
___	Sound the pile areas with a hammer and carefully probe with a thin-pointed tool such as an ice pick.
___	Check for pile shrinkage, overloading damage, connector corrosion, abrasion, and ice heaving damage.
___	Take a small boring for laboratory analysis using an increment borer if an area of rot or marine borer damage is in question. Once the core is extracted, seal the hole with a creosote treated plug to prevent easy access of borers to the interior of the pile.

**Figure 5-11 Timber Structures and Attachments (Below Water) Checklist**

___	Start at the splash/tidal zones. Note: A Level I inspection should be done first to identify areas of mechanical damage, repair and new construction.
___	Clear a section of the structure of all marine growth and visually inspect it for surface deterioration. This is done at spot locations rather than cleaning the entire structure.
___	Sound the cleaned area with a hammer and carefully probe with a thin-pointed tool, such as an ice pick.
___	If an area is in question, take a small boring for laboratory analysis using an increment borer. Plug the hole with a creosote treated plug to prevent easy access for marine borers.
___	Descend down to the pile, sounding the structure with a hammer wherever there is minimal marine growth, as well as probing carefully with an ice pick.
___	At the bottom, note and record the depth of the water on a Plexiglas® slate with a grease pencil.
___	Record visual observations, i.e., the presence of marine borers, losses of cross-sectional area, organism-caused deterioration, location and extent of damage, alignment problems, and condition of fastenings. Use calipers and scales and required.
___	Use ultrasonic techniques if internal marine borer damage is suspected. Ultrasonic techniques are available to support the underwater inspection program.
___	After finishing the underwater work, return to the surface and record all data into the inspection log. Similar procedures would be followed for timber retaining walls.

## 5-5 INSPECTION OF CONCRETE STRUCTURES

5-5.1 **Scoping the Problem.** Concrete damage appears in the following forms:

- Corroded rebar
- Alkali-silica reaction
- Freeze/thaw deterioration
- Abrasion wear
- Chemical deterioration from saltwater
- Overloading deterioration
- Shrinkage

These forms of damage are described in detail in Chapter 3. As with timber structures, concrete damage is found by walking the pier deck, inspecting below the pier deck in a small boat or barge, and underwater inspections.

The primary method of inspecting concrete is visual observation and sounding with a hammer. Only after problems are detected should other inspection methods be used. These other methods may include chipping away loose concrete to reveal the steel, coring, or Schmidt hammer.

5-5.2 **Surface Inspections.** Use Figure 5-12 “Concrete Structures and Attachments (Above Water) Checklist” to do a thorough inspection of all concrete structures and their attachments above water. Include annual load testing of the pier decking if heavy equipment or vehicles are to be driven onto the pier. Sampling equipment and inspection data to be compiled are given in Table 5-5.

Areas where the inspector should be particularly watchful for signs of deterioration, include:

- Inside corners and areas where radical changes occur in size of deck sections, curbs, and bollards.
- Construction joints.
- Poorly designed scuppers, drips, and curb slots, and other areas where inadequate drainage exists.

- Joints between the deck and pile cap, expansion joints where insufficient gap is allowed, and rigid joints between precast piles and cast-in-place pile caps.

**Table 5-5 Sampling Equipment, Measurements and Ratings for Concrete Structures**

Special Sampling Equipment	Measurement, Ratings or Samplings
Half-cell potential measurements	Location and size of damaged area
Schmidt hammer	
Hammer	
Chipping tool	Depth of chips, cracks, spalls, etc.  Powder samples for chloride contamination
Concrete-core rotary drill	Drilled concrete cores for laboratory analysis
Pachometer	Rebar locator

The inspector should be alert for any change in appearance of the concrete surface and any change in the sound from the hammer:

- Erosion of the surface material or by cracking on the surface are signs of chemical attack.
- Erosion of surface material is a sign of freeze-thaw deterioration.

Use a hammer or gad (sharp pointed tool) to chip or probe the surface to detect the depth of deterioration.

Corrosion of the reinforcement can be detected from rust stains on the surface. More advanced stages of corrosion is indicated by cracks that run parallel to the steel reinforcing bars. At times, corrosion is hidden from view, but will be indicated by a hollow sound from the hammer. This can occur on heavily reinforced slabs, such as pier decks, where the reinforcement has corroded enough to delaminate a layer of concrete at the level of the reinforcing mat.

**Figure 5-12 Concrete Structures and Attachments (Above Water) Checklist**

Deck Area	
___	Check horizontal and vertical alignment
___	Check for missing, broken, or loose connections, obstructions and other hazardous conditions of curbs, handrails and catwalks.
___	Check bollards, bits, cleats and capstans for wear, breaks, rough or sharp surfaces or edges, and missing or loose bolts.
___	Check deck drains and scuppers for loose, missing or broken screws, water ponding and other deficiencies.
___	Check manhole covers and grating for rust, corrosion, bent or worn hinge pins, and other damage.
___	Inspect concrete deck surface, curbs, utility trenches and gallery areas for cracks, spalling, loose joint sealers, and other damage. Closely inspect for corrosion of reinforcing steel and visual signs of rust.
___	Check ladders for corrosion, and broken, bent or missing rungs.
___	Check grounding connections for security
Exposed Area Under Pile or Along Wharf or Dolphin Assembly	
___	Check pile caps and bearing, batter and fender piles for damaged or broken members, cracks and spalling of concrete, rust stains, and exposed reinforcing steel.
___	Check for efflorescence, and general disintegration of the underside of pier decking and pile caps (Figure 5-13).
___	Check bottom scouring or undermining.
___	Check for evidence of shrinkage, swelling, and chemical deterioration; freeze/thaw deterioration; abrasion wear; and overload damage of piles as shown in Figure 5-14.
___	Sound the piling or structure with a hammer to detect any loose layers of concrete or hollow spots. A sharp ringing noise indicates sound concrete. A soft surface will be detected, not only by a sound change, but also by the change in the rebound, or feel, of the hammer. A thud or hollow sound indicates a delaminated layer of concrete, most likely for corrosion of steel reinforcement.



Figure 5-13 Inspection Areas for Visual Indications of Concrete and Reinforcement Deterioration

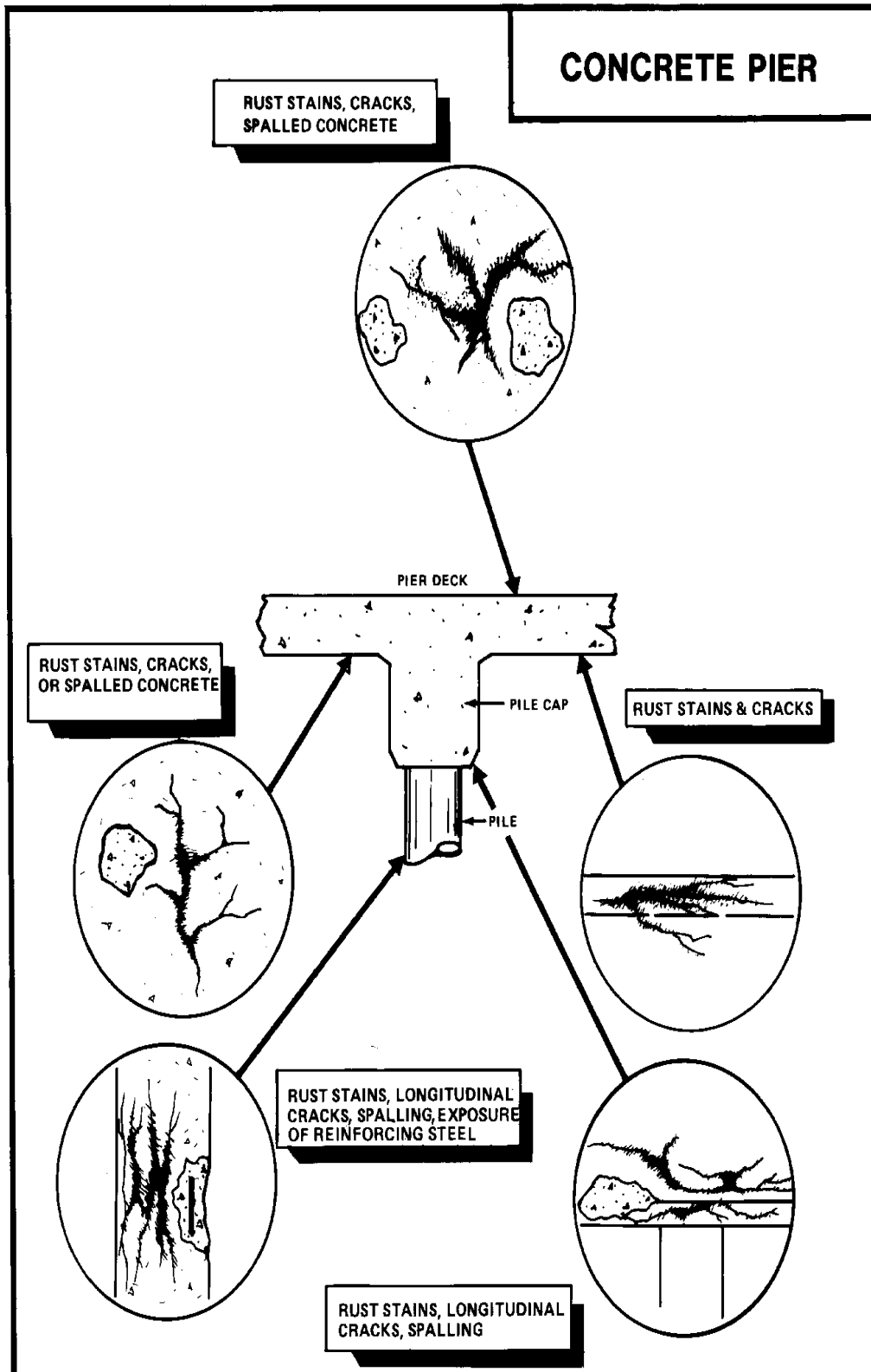
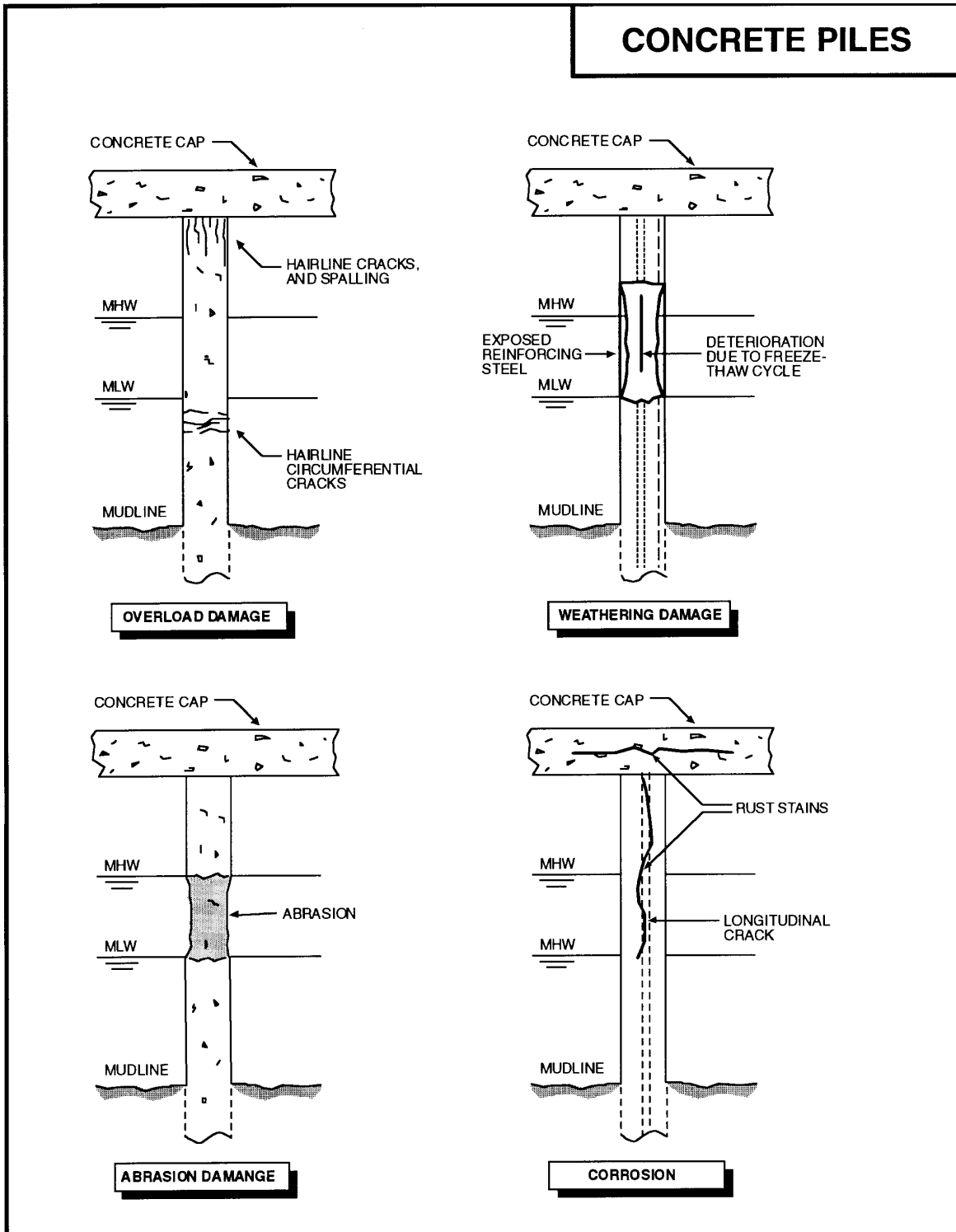

Figure 5-14 Typical Damage to Concrete Piles from Non-Biological Sources



Give special attention to cracks found on the surface of a concrete structure. Make sketches that show the length and direction of the cracks. Overall cracking patterns and changes in crack length, width and direction with time are meaningful data to a structural engineer. Photographs are helpful, but only as a supplement to the sketches.

If there is evidence of significant deterioration, more detailed NDT techniques may be used in a scheduled Level III inspection. Refer to the Level III test procedures for concrete inspection for mechanical and electrical test methods in the Paragraph entitled, "Level III Test Procedures for Concrete Inspection". The plan and sampling techniques shall be tailored to the specific areas of concern.

5-5.3 **Underwater Inspection.** Use Figure 5-15 "Concrete Structures and Attachments (Below Water) Checklist" to ensure that a thorough inspection of all concrete structures and their attachments below water is done. An engineer should explain to the diver exactly what should be looked for: number and size of piles, type and depth of bulkheads. The engineer will evaluate the diver's observations and determine the degree of corrosion.

5-5.4 **Level III Test Procedures for Concrete Inspection.** If signs of deterioration or damage are found by Level I or II inspections then a Level III inspection, involving either nondestructive or destructive tests, may be required. Level III concrete inspections use mechanical and electrical test methods.

Mechanical and electrical test methods include:

- The Schmidt test hammer may be used in order to compare the relative surface quality of concrete at different locations on the same structure. The instrument measures the hardness of concrete surfaces by the extent of rebound of a spring-loaded steel plunger in a tubular frame. The relative surface quality of the concrete, which is also an indication of its compressive strength, can be obtained. Surface texture may reduce values obtained.
- Core samples are destructive in nature and should only be used if other techniques cannot satisfactorily define the damage. Core samples may be taken from selected areas in order to determine the cause and depth of deterioration, chloride, ion contamination for petrographic analyses, and the actual compressive strength. Take special care when setting up to drill a core, in order to avoid hitting steel reinforcement, especially prestressed steel. Steel reinforcement near the surface can be located by using a pachometer (rebar locator). The length of the core sample should be twice the diameter. After the core has been taken, patch the hole with non-shrink cementitious mortar.

**Figure 5-15 Concrete Structures and Attachments (Below Water) Checklist**

___	Inspect the structure beginning in the splash/tidal zone. This is where most mechanical and biological damage is normally found.
___	Clear a section about 16 to 24 inches (40 to 60 cm) in length of all marine growth.
___	Visually inspect this area for cracks with rust stain, spalling or impact damage, and exposed reinforcing steel.
___	Sound the cleaned area with a hammer to detect any loose layers of concrete or hollow spots in the pile or structure. A sharp ringing noise indicates sound concrete. A soft surface will be detected, not only by a sound change, but also by a change in the rebound, or feel, of the hammer. A thud or hollow sound indicates a delaminated layer of concrete, most likely from corrosion of steel reinforcement.
___	Visually inspect the pile or structure where marine growth is minimal, and sound with a hammer.
___	Inspect, in greater detail, the base of mass concrete structures, such as retaining walls and foundations. These structures are prone to undermining by wave and current action, which, if not rectified, could lead to failure of the structure.
___	At the bottom, record the water depth along with any observations of damage on a Plexiglas® slate.
___	After returning to the surface, immediately record all information into the inspection log.

- ASTM C876, *Corrosion Potentials of Uncoated Reinforcing Steel in Concrete* can be used to determine the extent of active corrosion and the degree of susceptibility of corrosion in other areas in the structure. Corrosion can be detected before visible signs appear. The method detects corrosion by measuring the electrical potential of the steel. An electrical connection is made from one side of a voltmeter to an embedded steel-reinforcing bar that has been exposed. The other side of the voltmeter is connected to a copper sulfate half-cell, which is then put in contact with the concrete surface at various locations. The magnitude and sign of the resulting voltage is an indication of corrosion activity.
- Ultrasonic methods are available to inspect concrete for voids that cannot be seen, such as honeycomb pockets, and for internal deterioration by cracking. Pulse velocities and fundamental frequencies are imposed in the concrete structure to search for imperfections. Sonic methods conducted at specific time intervals can monitor progressive deterioration. Interpretation of data is a highly specialized skill.

Before starting any of the above tests, a test plan must be prepared and the areas to be tested must be cleaned thoroughly.

## 5-6 INSPECTION OF STEEL STRUCTURES

5-6.1 **Scoping the Problem.** There are six major types of steel structure deterioration to watch for in the marine environment:

- Corrosion
- Abrasion
- Loosening of structural connections
- Fatigue
- Overloading
- Loss of foundation material

The causes and forms of steel deterioration are described in detail in Chapter 3.

5-6.2 **Surface Inspections.** Generally, visual inspections will detect most forms of deterioration of steel structures. Use Figure 5-16 “Inspection of Steel Structures (Above Water) Checklist” to ensure a thorough inspection of steel structures above water is done. In the event that more detailed NDT techniques

are required under a Level III inspection, a plan and sampling techniques must be developed and tailored to the specific areas of concern.

Some types of corrosion, however, may not be detected by visual inspections. For example, inside steel pipe piling, anaerobic bacterial corrosion caused by sulfate-reducing bacteria (Figure 5-17) is difficult to detect by visual inspection. Fatigue distress can be recognized by a series of small hairline fractures perpendicular to the line of stress but these are difficult to locate by visual inspection. This type of problem, however, is more prevalent to offshore platforms with welded structural connections than to standard piers and wharves.

Cathodic protection systems need to be closely monitored both visually and electrically for signs of loss of anodes, wear of anodes, disconnected wires, damaged anode suspension systems, and low voltage.

Table 5-6 summarizes special sampling equipment, measurements required, and ratings used in the inspection of steel structures.

**Table 5-6. Inspection Equipment, Measurements, and Ratings of Steel Structures**

Special Sampling Equipment	Measurements, Ratings, or Samplings
Scale or calipers for determining thickness	Metal thickness
Ultrasonic equipment for determining thickness	Deformation of structural members Cathodic protection potentials
Voltmeter and half-cell for measuring electronic potentials on cathodically protected steel	Location and size of damaged areas
Pit Gauge	Depth of pits and extent of their occurrence.
Scraper	Samples of corrosion products or damaged coatings

5-6.3 **Underwater Inspections.** Use Figure 5-19 “Under Water Steel Structures Checklist” to ensure that a thorough inspection of underwater steel

structures is done. An engineer should explain to the diver exactly what to look for: number and size of piles, type and depth of bulkheads. The engineer shall evaluate the diver's observations and determine the degree of hazard.

**Figure 5-16 Inspection of Steel Structures (Above Water) Checklist**

Deck Area	
___	Refer to either Timber Structures (Figure 5-10) or Concrete Structures (Figure 5-12) Surface inspection Checklist, depending on construction.
Exposed Area Under Pier or Along Wharf	
___	Check for corrosion evidence: rust, scale and holes, in H-piles and sheet piling, especially in the splash zone and approximately 24 inches (60 cm) below mean water low water (Figure 5-17).
___	Sound the surface with a hammer to detect any scaled steel or hollow areas.
___	Indicate the location, extent and type of corrosion (density pitting, etc.) found.
___	Check for loosening of structural connections as indicated by misalignment of mating surfaces and by looseness or distortion of structural members
___	Check for deformation or distortion of a structural member in the form of a sharp crimp, or compression of a bearing or batter pile (Figure 5-18). This indicates possible overloading.
___	Check for deflection of steel sheet piling caused by failure of tiebacks or overload of backfill or live load.
___	Check for abrasion of steel structures as indicated by a worn, smooth, polished appearance.
___	Check for loss of foundation material caused by scour of materials from around the piles supporting the structural element (Figure 5-18). A loss of foundation material in front of a sheet pile bulkhead may cause kick-out of the toe of the wall and result in total failure.
___	Inspect welds for signs of corrosion, cracking or looseness.
___	Inspect coating or wraps for any peeling, blistering, erosion, tears, etc.
___	Inspect holes in steel sheeting for loss of backfill material through the opening and subsidence of adjacent ground surface.

Figure 5-17 Corrosion Damage to Steel Bearing and Sheet Piling

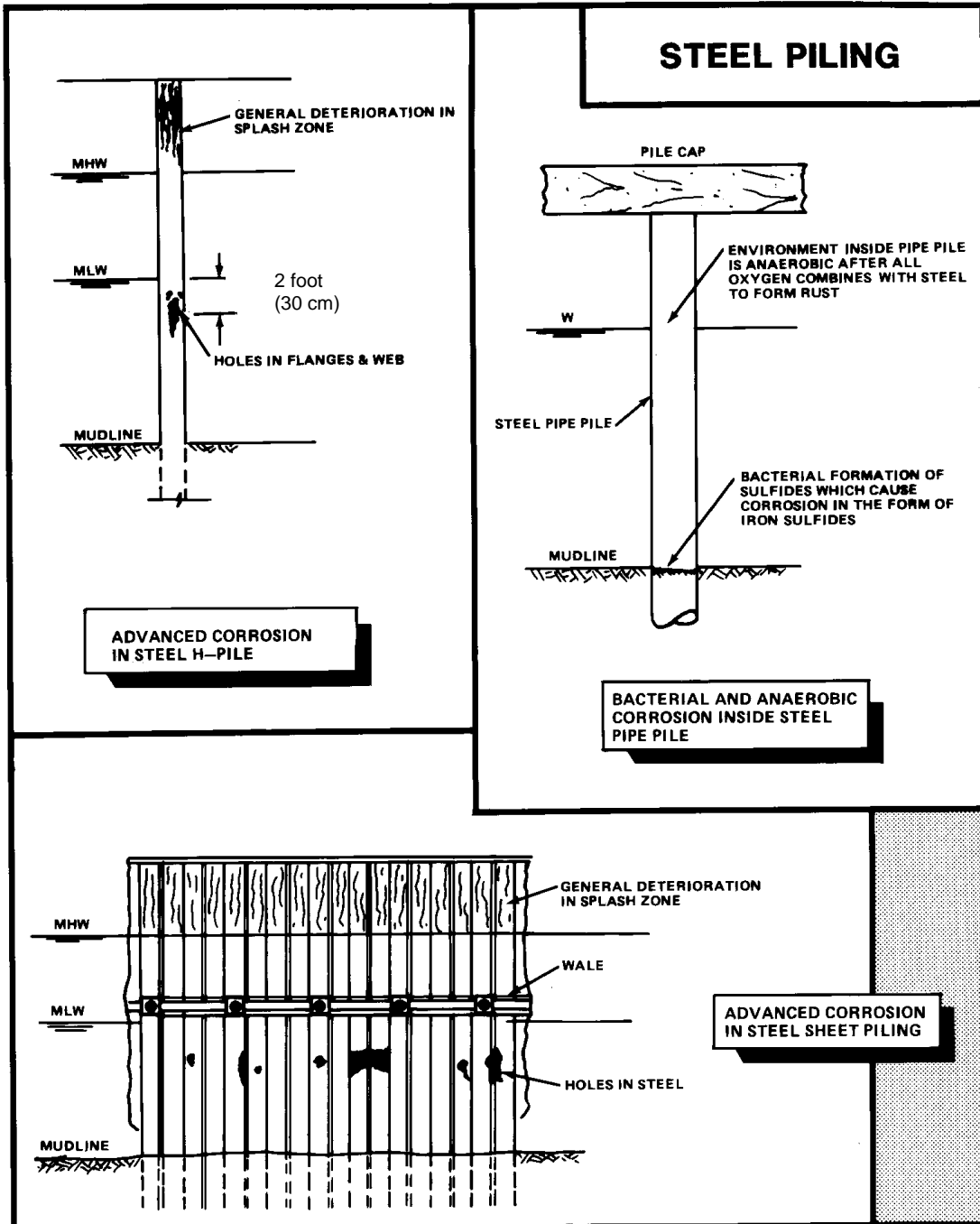
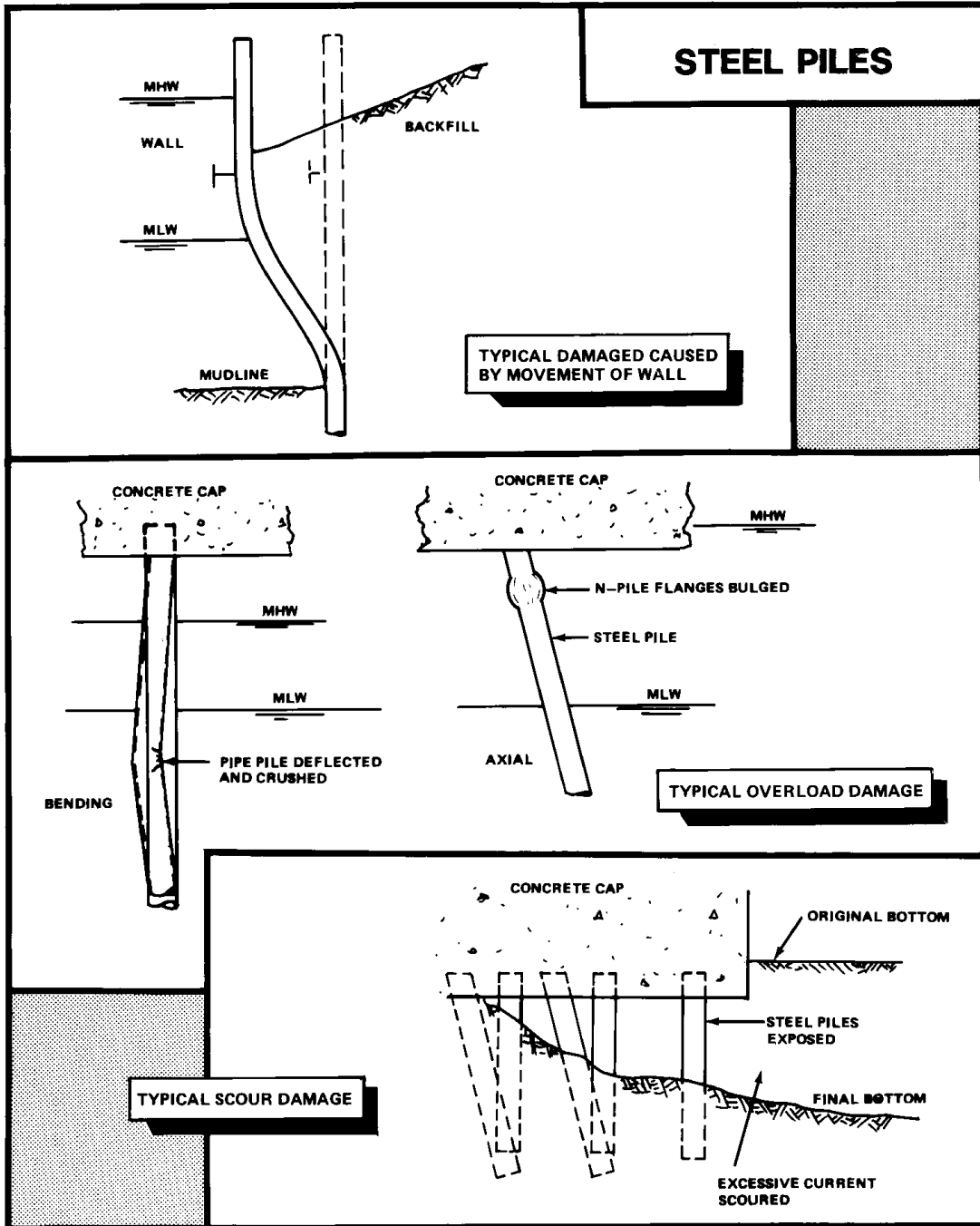



Figure 5-18 Damage to Steel Bearing and Sheet Piles from Overloading, Wall Movement or Scour.



**Figure 5-19 Underwater Steel structures Checklist**

___	Start the inspection at the splash/tidal zones and at depth of about 24 inches (60 cm) below mean low water (MLW). This is where most mechanical and corrosion damage is found.
___	Clean all marine growth from a 12 inch (30 cm) square section of pile (clean a larger area if inspecting sheeting) and visually inspect for rust, scale and holes.
___	If the structure has a cathodic protection system, check the cleared area with an underwater voltmeter to determine its effectiveness. Acceptable levels of cathodic protection are between -0.80 to -0.90 volts when compared to a silver/silver chloride reference cell.
___	Sound the surface with a hammer to detect any scaled steel or hollow areas. Inspect holes in steel sheeting for loss of backfill material through the opening and subsidence of adjacent ground surface.
___	Visually inspect the structure and sound with a hammer where there is minimal marine growth.
___	At the bottom, record the water depth, using a wrist depth gauge, on a Plexiglas® slate with a grease pencil.
___	Record other visual observations, such as coating condition (peeling, blistering, erosion). Closely inspect splices for loss of weld materials and looseness of splices.
___	Record the condition of cathodic protection equipment (broken or corroded conduits, loose wires, consumed or lost anodes).
___	Record the extent and type of corrosion, structural damage, or any other significant observations, using calipers and scales to determine thickness of steel flanges, webs and plates.
___	Return to the surface and immediately record the observation data in the inspection log.
___	If more sophisticated means are required to evaluate the condition of steel piling, ultrasonic inspection is available for more complete thickness measurements. These measurements must be made in areas clear of all marine growth and scale. Using ultrasonic equipment in areas with corrosion pitting can give erroneous thickness measurements. Magnetic particle inspection may be used, particularly on welded connections, to detect cracks and small defects.

## 5-7 INSPECTION OF SYNTHETIC MATERIALS AND COMPONENTS.

Inspection of synthetic materials and components is subdivided into the following three categories:

5-7.1 **Structural Members.** Structural members should be inspected annually. The inspection should detect:

- Cracked, worn, brittle, or deformed plastic railings, stanchions, gratings, light standards, or piping; loose or damaged fittings and connections; and exposed fiberglass.
- Cracked, worn, or deformed rubber resilient fender components, and/or loose or damaged fittings and connections.

Basic inspection procedures are the same as those outlined for timber or concrete structures.

5-7.2 **Coatings, Patches and Jackets.** Coatings, patches, and jackets should be inspected annually, or more frequently, depending on the failure rate of the application. The inspection should detect:

- Pits, cracks, scars, or abrasions in coatings.
- Cracked, loose, or dislodged epoxy patches.
- Punctures, brittleness, tears, rips, or abrasions in fabric, or unlocking of fabric seams in pile jackets.

Basic inspection procedures are the same as those outlined for timber, concrete, and steel structures.

5-7.3 **Foam-Filled Fenders.** Foam-filled fenders should be inspected more than normal pier inspections and should cover:

- Condition of the fender-to-pier connection hardware. Check for operability and signs of corrosion. Check to ensure that the fender is constrained horizontally so that it contacts the bearing surface for its full length. Ensure that the fender is free to vertically float with the tide and rotate around its long axis.
- Condition of the fender chain and tire net for net fenders. Check to see that the chain is symmetrical on the fender and that the end fittings are in good working order. Ensure that the chains are protected from the ship hull by the tires, and that the net is not loose.

- Condition of end fittings on netless fenders. Check to see that the fittings are in good working order, and corrosion is minimal. Check to see that the fender shell is not cracked or separated around end fittings.
- Condition of the fender elastomer shell. Check for cuts, tears, and punctures. Record the size and location of damage on a sketch.
- Measure or estimate the diameter of the fender at its smallest point to record permanent set.

Inspections will be done by walking the pier and using a small boat.

Record keeping for foam-filled fenders is very important. In this regard, the fenders should be treated as an item of high-cost equipment rather than an appurtenance to a fixed facility. Each fender should have a unique identification number with a history record that includes date of procurement, manufacturer, date of installation or when fender was put into service, and berth location if permanently installed.

**5-8 INSPECTION OF QUAYWALLS.** Quaywalls are an integral part of wharves and should be included when other pier components are inspected.

Deterioration of quaywalls is indicated by:

- Shifts in horizontal and vertical alignment of sheet piling.
- Damage or deterioration of the wood, concrete, or steel sheet piling.
- Wash-out of substrate under the sheet piling, particularly at the toe of the structure.

Alignment shifts can be detected by visual observation. A complete description of shifts and any apparent cause should be provided. Deterioration of wood is covered by the Paragraphs entitled, "Inspection of Timber Structures", "Inspection of Concrete Structures" and "Inspection of Steel Structures". Wash-out may be detected by visual inspection in clear water at low tide. If not, then an underwater inspection is required. Figure 5-20 "Quaywall Surface and Underwater Inspection Checklist," is a useful guide.

**Figure 5-20 Quaywall Surface and Underwater Inspection Checklist**

___	Swim around the base of the structure looking for weaknesses in the base of these structures, e.g., washout of small stones and core material.
___	Note signs of detrimental wave action, e.g., scouring and sloughing.
___	Record all pertinent information on a Plexiglas® slate and transfer the information to the inspection log.
___	Record the result of the above water inspection, which should include a description of the alignment and general condition of the seawall.

5-9        **THE INSPECTION REPORT.** For each inspection, a report is prepared. The report includes facility plans with updated descriptions, such as: size and pile arrangement, an evaluation of the assessed conditions, and recommendations for further action. The report should provide enough technical detail to support the assessments and recommendations. The Paragraph entitled, “Planning for Inspection” provides guidance for preparing inspection documentation to be used in preparing the report.

NAVFAC MO-322, *Inspection of Shore Facilities* calls for a three-part inspection report package for shore facilities consisting of a: facility inspection checklist, facility condition summary report sheet, and facility condition detailed deficiency list. Forms for these three sections are shown in Chapter 4, Volume 1 of MO-322. They are, however, geared more for inspecting buildings and are not specifically designed for waterfront structures.

Since waterfront inspections are specialized, a report format such as the one presented in Table 5-7 would be more appropriate. This format is used by NFESC \1\1/ when conducting underwater inspections and assessments at Naval waterfront facilities.

**Table 5-7. Report Format of Underwater Inspections and Assessments**

Report Cover

Title Page

Executive Summary

Executive Summary Table

Table of Contents

List of Figures

List of Photographs

List of Tables

Body of report:

Section 1: Introduction

1.1 Background/ Objectives

1.2 Inspection Exit Briefing

Section 2: Activity Description (Information that affects inspection, repair, rate of deterioration, etc.)

2.1 Location

2.2 Existing Waterfront Facilities at Activity

2.3 Waterfront Facilities Inspected

Section 3: Inspected Facilities

3.1 Name of Facility

3.1.1 Description of Facility

- 3.1.2 Observed Inspected Condition
- 3.1.3 Structural Condition Assessment
- 3.1.4 Mooring Hardware Assessment (Note 1)
- 3.1.5 Recommendations

Repeat the above as necessary for each facility

#### Appendices

- A - Key Personnel
- B - Inspection Procedure/Level
- C - Structural Data
- D - Pertinent Background Information
- E - Calculations for Structural Assessment
- F - Backup Data for Cost Estimates
- G - Cost Estimate Summary
- H - References

Note 1: With increased emphasis on Heavy Weather Mooring, pay particular attention to mooring hardware, i.e. type, location, strength, capacity of cleats, bits and bollards.

*This page intentionally left blank.*



## CHAPTER 6

### REPAIR OF WOOD AND TIMBER STRUCTURES

6-1 **GENERAL.** The most common uses of wood and timber structures in waterfront facilities involve:

- Older piers, wharves, bulkheads, and quaywalls constructed from dimension lumber, beams and stringers, and round timber piles.
- Fender systems constructed from beams and stringers and round timber piles
- Pile dolphins constructed from round timber piles.
- Log floats and camels, glued and laminated wood, and miscellaneous forms.
- Degaussing facilities that require using nonmagnetic construction materials.
- Groins constructed from beams and stringers and round timber piles.

With the exception of fender systems, floats and camels, most systems have been installed for several decades, in many cases dating back to World War II.

The need to conduct an effective repair program for these facilities is essential if the facilities will continue to be used and if escalating costs of repairs are to be avoided. Postponing the repairs, particularly for bearing piles, can lead to costly replacement or downgrading of the structural capacity of the facility.

6-1.1 **Repair Methods.** Repair methods for wood and timber structures are generally directed at correcting one or more of the following problem areas: fungal decay, insect damage, marine borer deterioration, abrasion, and overload.

The repair methods to be used must consider the following elements.

- Facility mission and required life.
- Extent of damage and deterioration.
- Estimated life expectancy with and without repairs.
- Projected load capacities.

- Problems associated with mobilization of equipment, personnel, and materials to accomplish repairs/maintenance.
- Economic trade-offs.

6-2 **REFERENCES.** Materials used to develop repair techniques and planning factors outlined in this section have been taken, in part, from:

- Scheffer, T.C., *Observations and Recommendations Regarding Decay in Naval Waterfront Structures*, Forest Products Laboratory, September 1966.
- Morrell, J. J. and et. al, *Marine Wood Maintenance Manual: A Guide for Proper Use of Douglas-fir in Marine Exposures*, Forest Research Lab, Oregon State University Research Bulletin 48, October 1984.
- Childs Engineering Corp., *Survey of Techniques for Underwater Maintenance/Repair of Waterfront Structures*, Revision No. 1, for the Naval Civil Engineering Laboratory, December 1985.
- \1 Southern Forest Products Association /1/, *Marine Construction Manual: A Guide to Using Pressure-Treated Southern Pine in Fresh and Saltwater Applications*, October 1994.

6-3 **PLANNING THE REPAIRS.** Repairing timber structures will be controlled by the availability of skilled personnel and equipment. In many cases structural repairs, particularly those involving bearing and sheetpiling, will be done by contract.

6-3.1 **Reviewing Inspection Reports.** The initial planning step must involve a review of prior inspection reports to determine the scope and rate of damage or deterioration, and specific operational constraints placed on the facilities because of the deterioration. Once the scope of repair requirements (including priorities) is established, determining how to do the repairs (whether in-house or by contract) must be determined.

6-3.2 **Engineering Considerations.** Any repair of structural members will require experienced design professionals with knowledge of local tidal conditions, building codes, materials, substrate analysis, and construction practices.

6-3.3 **Special Skill Requirements.** Surface repairs covering pier decking, string pieces, stringers, pile caps, braces, and fender piles require skills common to the wharf-building trade. Underwater repairs, however, require special skill levels that may not be available with in-house forces. This includes how to remove marine growth, jetting or air lifting procedures, underwater cutting and

drilling techniques, and jacketing and wrapping materials used in underwater construction.

6-3.4 **Equipment Requirements.** Surface repairs to the pier superstructure and fender system require equipment common to in-house shop forces. Equipment for underwater repairs, however, may include:

- High-pressure water blaster
- Hydraulic grinders with barnacle buster attachment
- Hydraulic drill with bits
- Hydraulic power unit
- Hydraulic chain saw
- Concrete pump with hosing
- Jetting pump and hose
- Rigging equipment
- Float stage and scaffolding
- Clamping template for cutting piles
- Special clamping equipment
- Crane

6-4 **REPAIR PROCEDURES.** Repair procedures for waterfront wood and timber structures are summarized in Table 6-1. Using any of the repair techniques that follow should adhere to the preservation treatment requirements outlined for wood and timber structures in Chapter 3.

Every effort should be made in rafting and handling to prevent damage to treated piles and timbers, particularly in portions of the work exposed to marine borer attack. Care should also be taken in driving piles to prevent checking or splitting of the treated wood, and butts shall be trimmed and headed so that the hammer will strike only untreated wood. Piles and timbers should be inspected before and during the time they are driven or placed. Where the protective preservative shell is broken or damaged in any way, the holes or crevices should be repaired by drilling, and neatly and tightly plugged in accordance with AWWA Standard \1\ U1 /1/. Where abrasions or other damages cannot be sealed against marine borers,

other protection must be provided in an approved manner. All piles shall be handled in accordance with AWPA Standard \1\ U1 /1/.

**Table 6-1 Repair Techniques for Wood and Timber Structures**

Repair No.	Description
<b>PIER SUPERSTRUCTURE AND FENDER SYSTEMS</b>	
TR-1	Repairing timber pier superstructure
TR-2	Repair by replacing timber fender pile and damaged chocks and wales
<b>BEARING PILES</b>	
TR-3	Protecting timber piles with Polyvinyl Chloride Polyethylene Wrapping
TR-4	Partial posting of damaged pile with concrete encasement
TR-5	Repairing timber piles with concrete encasement
TR-6	Repair of retrofit timber piles with an underwater curing epoxy and fiber-reinforced wrap
TR-7	Replacing damaged pile with new timber pile under timber pier deck
TR-8	Replacing damaged pile with new concrete pile under concrete deck
<b>TIMBER SHEET PILING WALLS</b>	
TR-9	Reinforcing tie-back system for timber sheet piling wall
TR-10	Installing a tie-back system on the top of a timber sheet piling wall
TR-11	Installing a concrete cap / face on a timber sheet piling wall
<b>DOLPHINS</b>	
TR-12	Repair of dolphins

**6-5 ENVIRONMENTAL CONCERNS.** Federal environmental regulations allow the use of treated wood in the marine environment. A possible exception is the sheen created when creosoted piling is driven but this can be mitigated. Wood preservatives are EPA-registered pesticides and treated wood products for the marine environment will be widely available for the foreseeable future. Treated wood removed from service is not a hazardous waste and is not banned by Federal law from landfills.

Local and state environmental regulations, especially along the west coast, have restricted the marine use of treated wood. In some cases, where there is cause for environmental concern, conduct a site-specific risk assessment before starting on a project that involves installing a large amount of treated wood in the marine environment.

The handling of treated wood removed from service should be considered as an important part of any repair project. Discarded treated wood may generally be disposed at municipal landfills approved to receive the material by the state or

local authorities. Some non-hazardous waste landfills, however, may classify treated wood as a “special waste” and require documentation of its status. Reuse of treated wood is a preferred option and is not currently regulated by Federal law, provided such reuse is consistent with the intended end use. Examples of reuse include fence posts, retaining walls, landscaping, decking, bulkheads, general construction, etc. Energy recovery may be an option if there is a facility relatively near that uses treated wood waste as a fuel. Bioremediation is another option that is encouraged, but is not yet widely available.

Since potential restrictions can vary widely with locale and can change, contact your Environmental Office before using, recycling, or dispersing of treated wood.

6-6        **QUALITY ASSURANCE CONCERNS.** In the recent past, Navy activities have too often accepted and used treated wood products that did not meet industry standards. This has resulted in poor performance and costly premature failure of waterfront wood structures and the perception that wood products are inappropriate for modern facilities. It is imperative that industry best management practices (BMP) be used to avoid receiving unacceptable treated wood products. These BMP include:

- Specify the appropriate material in terms of performance as defined in the \1\ American WoodProtectors Association /1/ Standards. Specify that wood treatments and handling methods comply with current industry BMP.
- Specify that treated wood be inspected by an independent agency certified by the American Lumber Standards Committee. Specify an on-site inspection before installation to assure proper lumber grades, moisture contents, and treatment standards have been met. For environmental reasons, if the treated wood does not appear clean and dry, i.e., no surface deposits, it should be rejected.

## TR-1: REPAIRING TIMBER PIER SUPERSTRUCTURE

**Problem:** Wood components are damaged and no longer fully serve intended purpose or present a safety risk.

### Description of Repair:

**Decking.** Replace decking with properly treated quarter-sawn timber or other suitable material when its top surface becomes uneven, hazardous, or worn to a point of possible failure. Spacing between decking planks is normally provided for ventilation and drainage. Blacktopping of decking may not provide a completely protective cover against rain wetting beneath it because cracks often develop in the material. Limit washing decks with freshwater as this promotes wood decay.

**Pile Caps.** Replace decayed or damaged pile caps with properly treated wood (including glulam) or other suitable material. Replacement caps should be the same size and length as the original caps unless redesigned.

**Curbs, Chocks, and Wales.** Replace these members with properly treated lumber (including glulam) or other suitable material when decay or other damage renders them unfit for service. Make butt-type joints, not lap-type joints, in connecting wood curbs and wales to reduce decay damage potential. Replacement sections should be long enough to reach a minimum of two bents. Place new preservative-treated wood blocks or other suitable material, 2 to 3 inches (5 to 8 cm) thick, under each curb (upper string piece) replacement section at intervals of about 3.3 feet (1 meter) to provide for drainage (Figure 6-1).

**Braces.** Replace diagonal braces that are broken or attacked by fungi or marine borers with wood or other suitable material. Place pressure-treated wood braces well above high water and treat all bolt holes with a preservative. An alternative to using pretreated wood is plastic barriers, either polyethylene or polyvinyl chloride plastic wraps or polyurethane coatings. The braces, with bolt holes, can be fashioned to fit and the plastic applied before the braces are attached to the pier piling. Where braces are fastened to a piling, the pile should not be cut or dapped to obtain a flush fit. Where decking has been removed for repairs, it is often possible to drive diagonal brace piles to provide lateral stiffness. This procedure eliminates all bolt holes except those at the top of the structure immediately below the decking.

**Stringers.** Replace decayed or damaged short stringers with properly treated wood or other suitable material. Replace decayed or damaged areas of long stringers with new sections. Make connections between replacement and existing stringers directly over a pile cap and stringers. Tightly bolt or pin the

stringers to the pile cap (Figure 6-1). Stagger the splices in adjacent stringers where possible. Avoid checks and splits, which promote decay, when driving deck spikes by pre-drilling small holes.

***Fire Curtain Walls.*** Wood fire curtain walls are usually made of two layers of planking that run diagonally to one another. Replace all deteriorated planks to restore the wall to its original condition - as watertight as possible. In addition, each side of the wall should be protected by automatic sprinklers or by nearby openings in the deck through which revolving nozzles or other devices can be used to form an effective water curtain.

**Application:** These methods are routinely used.

**Future Inspection Requirements:** Areas near replaced wood may be susceptible to similar damage and should receive special emphasis in future inspections.

Figure 6-1 Repairs to Timber Pier Structure

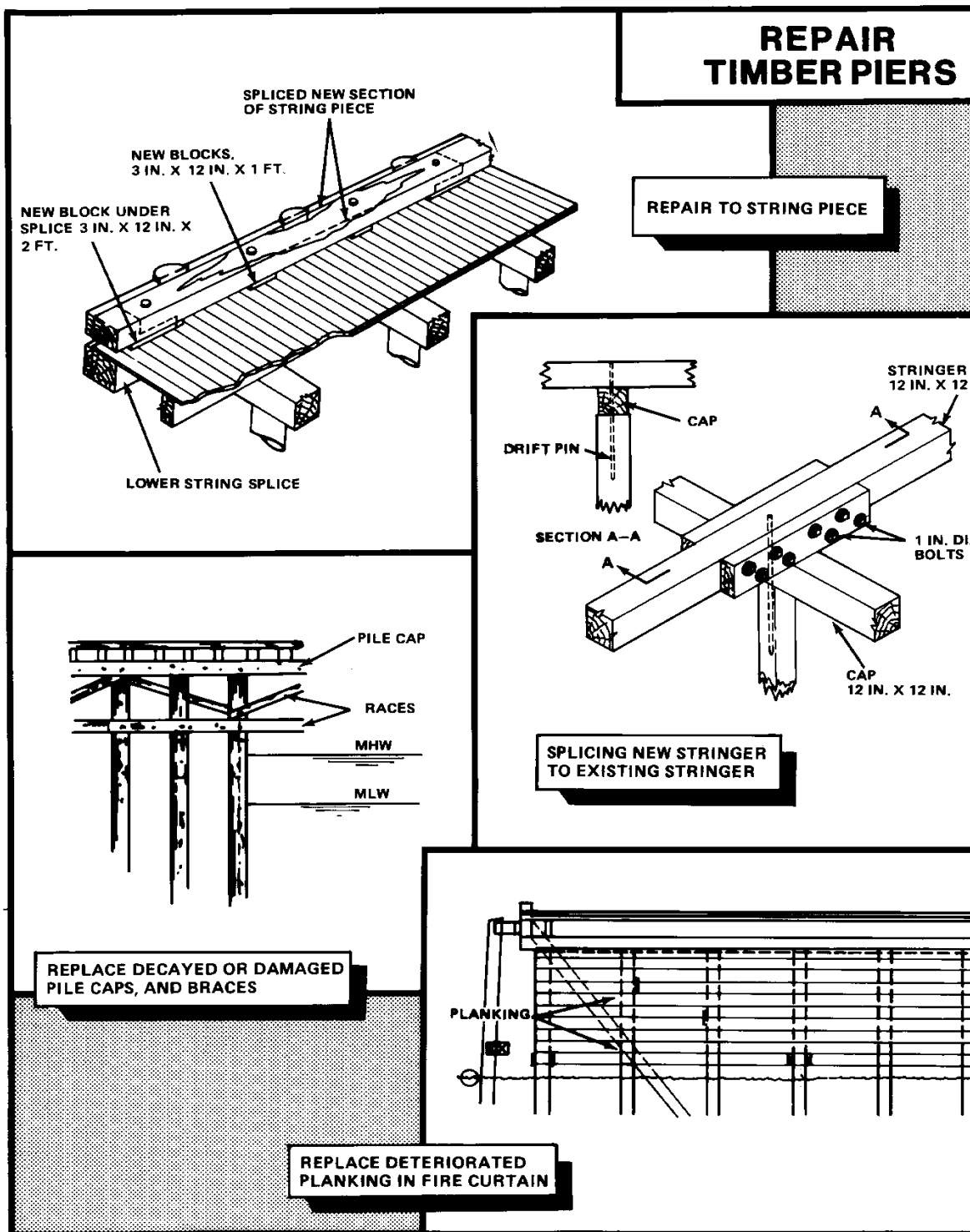



**TR-2: REPAIR BY REPLACING TIMBER FENDER PILE  
AND DAMAGED CHOCKS AND WALES**

**Problem:** Fender pile broken or damaged and no longer functional.

**Description of Repair** (see Figure 6-2): Pull and replace decayed, marine borer damaged, or broken fender piles with new piles. Consider using alternative materials instead of treated wood for the new piles. Recommend installing a steel shoe on the outer surface of each wooden fender pile.

Replace deteriorated chocks with tightly fitting chocks that are bolted to one string piece or to a wale below the deck. Wood treatment requirements will be locally determined.

Replace deteriorated or damaged wales with the same size and length as the original wales unless redesigned. Wood treatment requirements for the wales will be locally determined.

**Application:** Repair by replacement is applicable to virtually all timber fender systems.

**Future Inspection Requirement:** Inspections should be based on historical records of fender pile damage.

Figure 6-2 Repair by Replacing Timber Fender Pile and Damaged Chocks and Wales

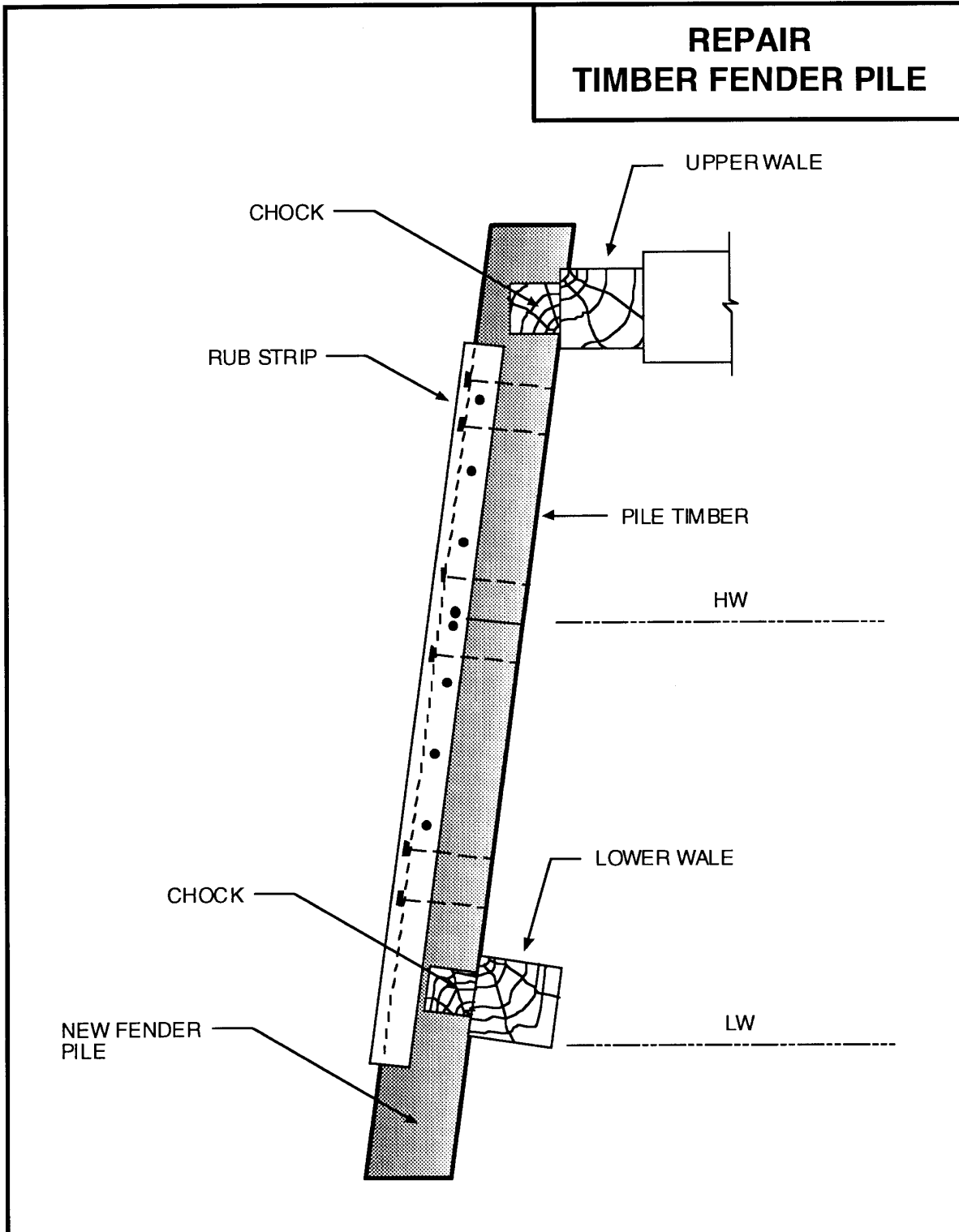

**TR-3: PROTECTING TIMBER PILES WITH POLYVINYL CHLORIDE  
OR POLYETHYLENE WRAPPING**

**Problem:** Either a new pile or pile butt is being installed that requires a protective covering or marine borer deterioration has been discovered in an existing pile, and further damage needs to be prevented. This method can also be used to protect untreated piling from marine borer damage.

**Description of Repairs:** Clean the surface of the pile to remove all sharp or protruding objects that would penetrate or deform the plastic wrapping on the pile.

“If a polyvinyl chloride (PVC) wrap is used on a relatively new creosoted piling, first wrap a 1.0 mm (4-mil) polyethylene sheet around the pile to protect the PVC wrap from the creosote. Install the PVC or polyethylene (PE) wrap starting with the upper intertidal unit at least 30 cm (1 foot) above mean high water (MHW). The lower units then overlap the upper units and extend below the mudline. Tighten the PVC wrap using wood poles and a ratchet wrench. Fasten the wrapper with aluminum alloy bands around the top and bottom and with aluminum alloy nails along the vertical joints (see Figure 6-3).”

Once the wrap is completed, backfill the area around the base of the pile.

**Application:** This method is widely used for preventing or arresting marine borer attack. It is more economical than concrete encasement or pile repair or replacement. Plastic wraps have been placed on creosoted piling in California to prevent the migration of creosote into the water, thus avoiding any environmental restrictions. Using a 150-mil (3.8 mm) polyethylene wrap in the intertidal area can provide protection against abrasion.

**Future Inspection Requirement:** Look for punctures or tears in the plastic wrap; any damage to wraps over untreated piles can result in rapid borer damage.

Figure 6-3 Wrapping Timber Piles with Polyvinyl Chloride

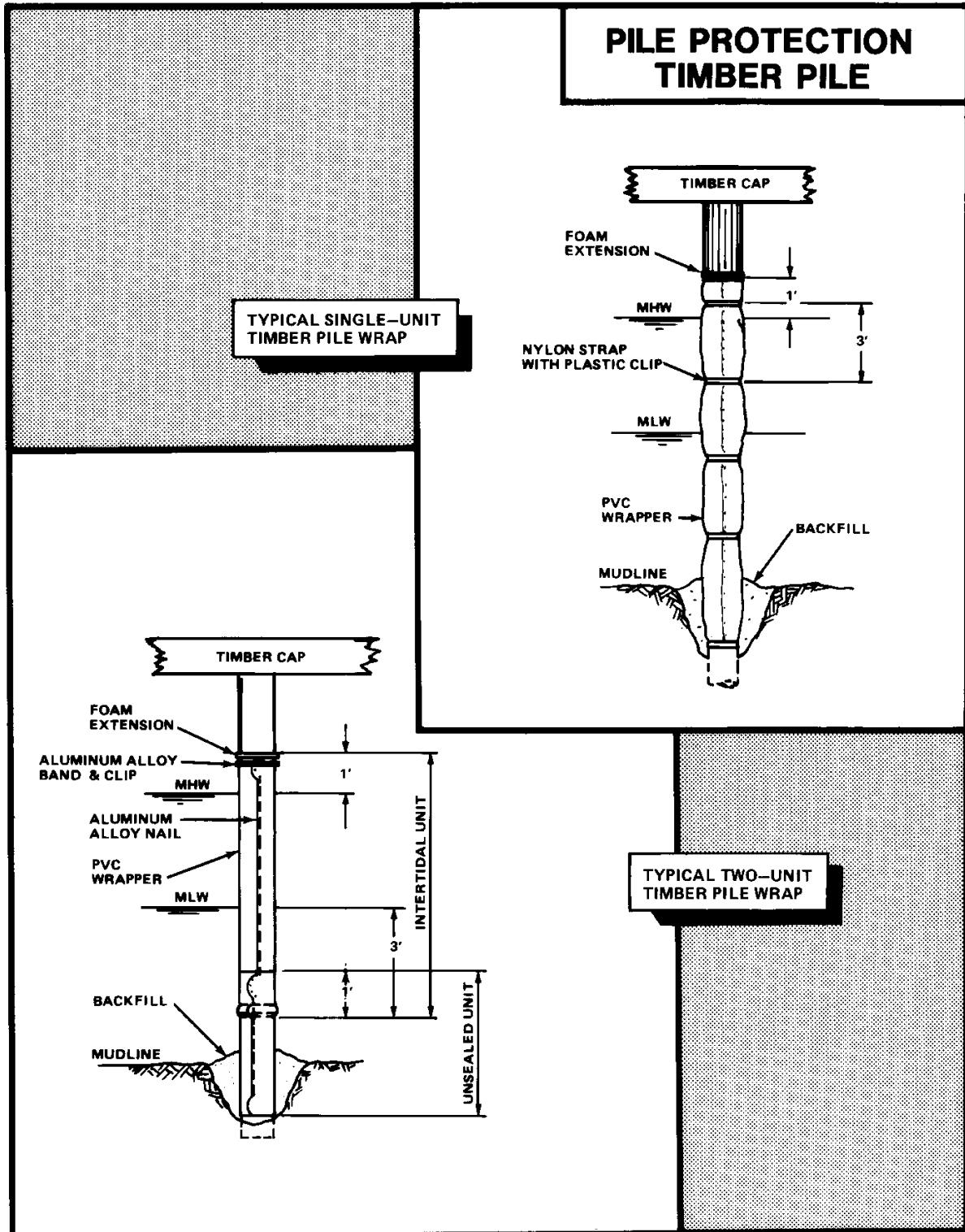

#### TR-4: PARTIAL POSTING OF DAMAGED PILE WITH NEW PILE BUTT

**Problem:** Top of pile has rotted or has major insect damage. No other major detectable deterioration of piling found.

**Description of Repairs:** Cut the pile below the damaged, rotted, or insect infested area. Cut the pile butt to length and shape head to fit pile cap (if required). See Figure 6-4 for two methods of interfacing pile butt with pile cap. Make the joint with two pretreated timber fishplates bolted to existing pile and pile butt using 100 mil (2.55 mm) galvanized bolts. Treat the ends of all cuts with creosote. Treat bolt holes with the same wood preservative as used for the pile butt. Place shims between new pile butt head and pile cap. Bolt pile or fishplates, depending on the method selected, to pile cap.

When adjacent timber piles have been repaired using either posting or fishplating techniques, it is necessary to provide some resistance to lateral loads imposed on the structure. This can be done by installing X-bracing between piles, as illustrated in Figure 6-4. Treated timbers are fastened high on one pile and low on the adjacent pile, forming an X pattern. Where X-bracing crosses, a timber spacer should be bolted between the bracing pieces to shorten the unsupported length of span.

**Application:** This method works well where not many piles need repair. This method may be more expensive than replacing the pile. The cause of damage, e.g., water entrapment, must be remedied before using this method.

**Future Inspection Requirement:** Even with X-bracing, weak joints will exist where column buckling may occur. All splices and holes below MHW may be subject to accelerated marine borer attack. This may be offset by adding a PVC wrap around the splice. Above MHW these areas are subject to accelerated fungal attack.

Figure 6-4 Posting Timber Pile with Pile Butt and Fish Plates

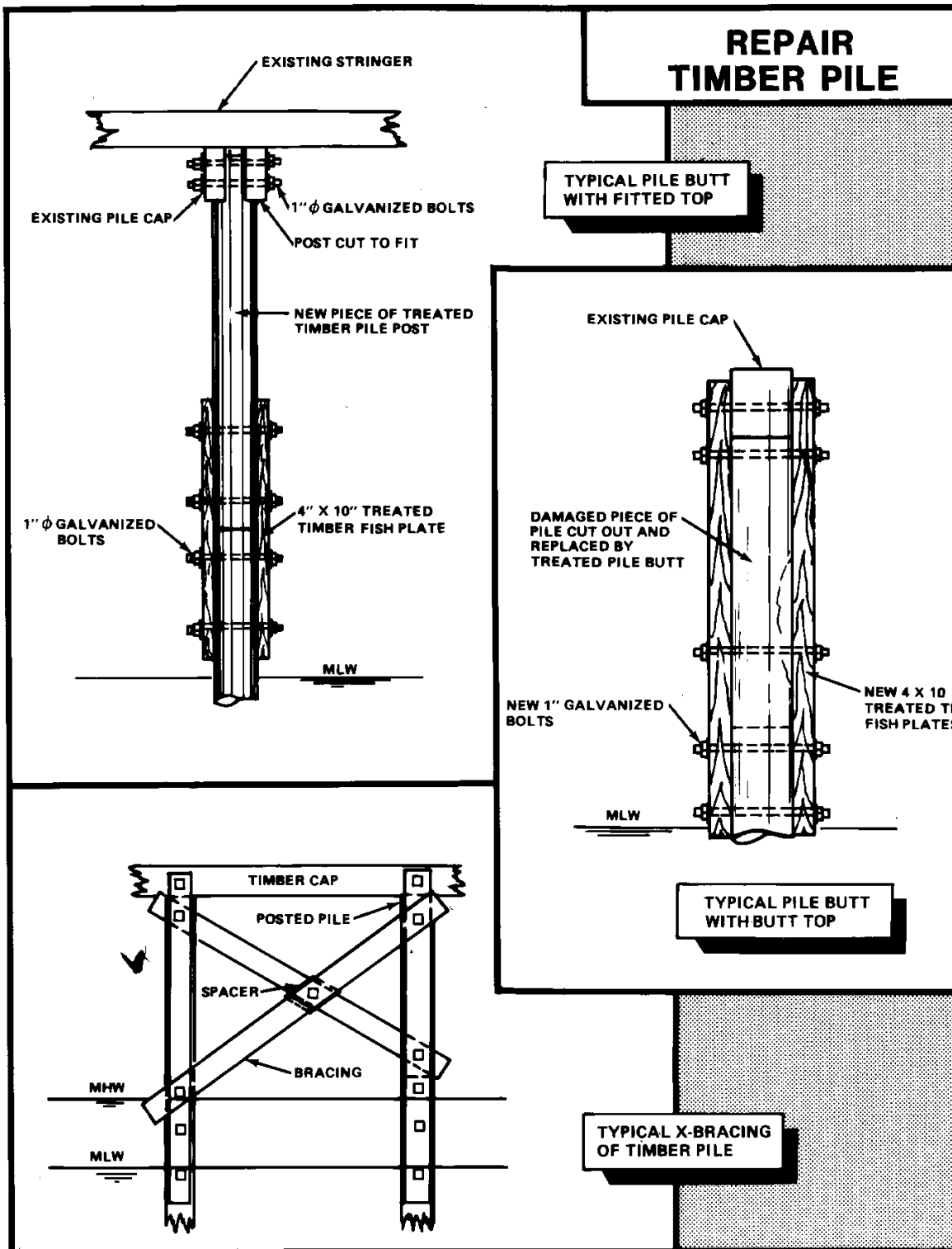

## TR-5: REPAIRING TIMBER PILES WITH CONCRETE ENCASEMENT

**Problem:** Approximately 10 to 50 percent of the cross-sectional area has been lost as a result of marine borer attack.

**Description of Repairs:** Clean the timber pile thoroughly from below the mudline to above MHW. Two types of forms are available:

- Flexible forms
- Split fiberboard forms

After piles have been thoroughly cleaned, place a 6- by 6-inch (15- by 15-cm) reinforcing mesh around the pile, using spacers to maintain clearance between pile, reinforcing, and fabric form. The fabric form should be placed around the pile.

For the flexible form, the zipper should be closed, and the form secured to the pile at top and bottom with mechanical fasteners (see Figure 6-5).

For the fiberboard form, straps are installed and secured every 1 foot (30 cm). Maintain a minimum of 1-9/16 inch (40 mm) spacing between pile and reinforcing and between reinforcing and form (see Figure 6-5).

The space between pile and form is then filled to overflowing with concrete grout. Use a tube or hose extended to the lowest point of the form.

The form is left in place and the base is backfilled to above the concrete.

**Application:** This method can be used as a repair or as protection against marine borer attack and abrasion, and may be more expensive than replacing one or more timber piles. Economics will dictate decision.

**Future Inspection Requirement:** Increased inspections may be required to detect signs of ripped fabric forms, unzipped or locked form seams, or abrasion and failure of concrete encasement.

Figure 6-5 Concrete Encasement Repairs to Timber Pile

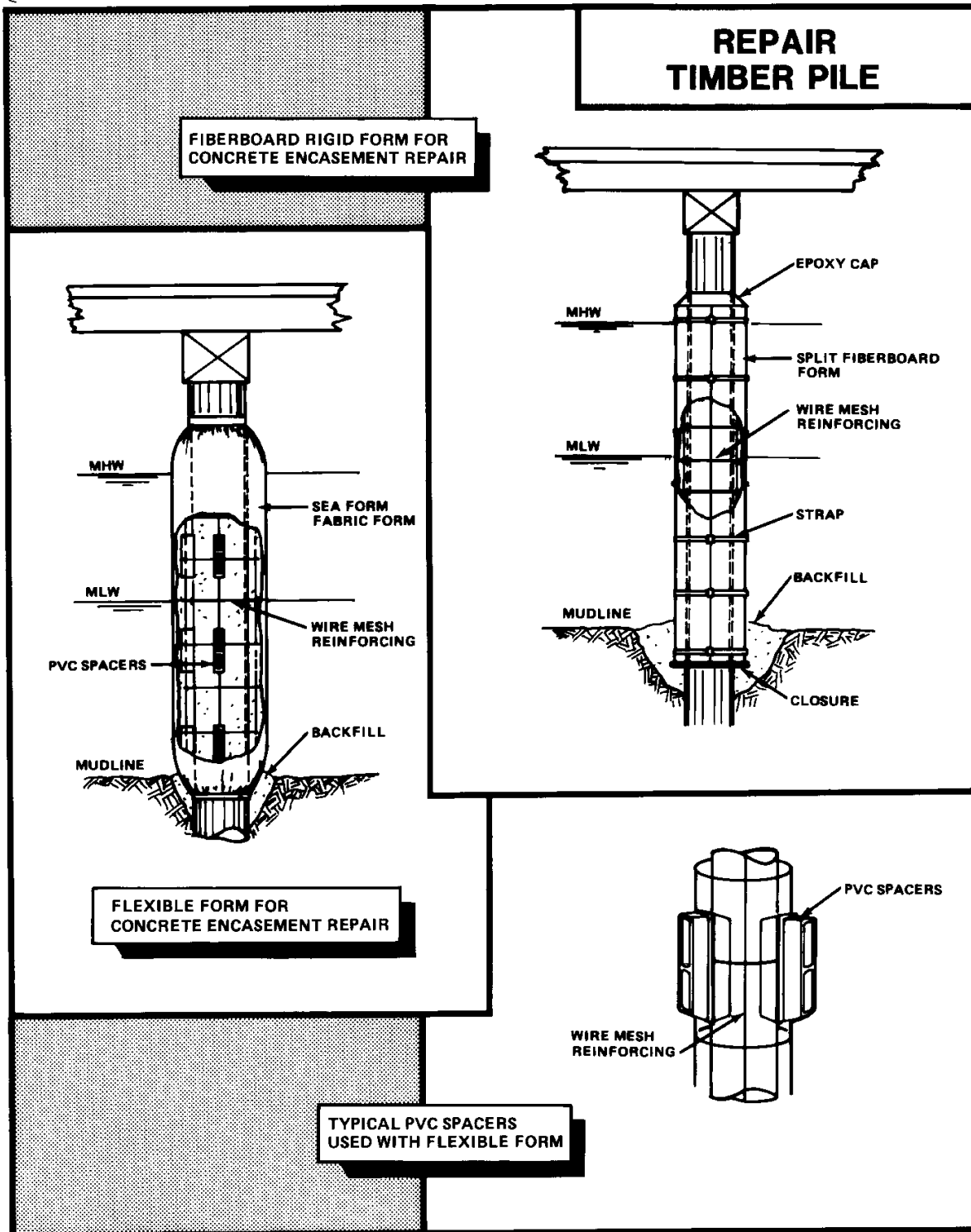



**TR 6: REPAIR OR RETROFIT TIMBER PILES WITH  
AN UNDERWATER CURING EPOXY AND FIBER-REINFORCED WRAP**

**Problem:** Pile deterioration by marine borers has occurred. Load requirements preclude resolving the problem by using PVC or PE wraps or an increase in strength (retrofitting) of intact piles is desired. In either case, deterioration cannot be so extensive as to require replacing the pile.

**Description of Repair:** Remove rotted or damaged wood and all sharp or protruding objects that could penetrate or deform the fiber wrap of the pile to be repaired or retrofitted (see Figure 6-6). Fill in any holes and gaps with material recommended by the system manufacturer. Saturate the wrap with the underwater curing epoxy before applying. Apply vertical layers of the fiber wrap with a 6-inch (15-cm) overlap. In most cases, it is advisable to wrap the fabric around the pile from below the mudline to above the high water mark. Apply horizontal layers of the fiber wrap with a 6-inch (5-cm) overlap. Additional vertical and horizontal wraps are applied as required for sufficient strength and as recommended by the manufacturer.

**Application:** This technology is designed to increase pile strength characteristics, but may be limited by cost and confidence levels. In most cases, PE or PVC wraps or pile replacement will be more cost effective for damaged piles. In addition, because this is a relatively new technology option, long-term performance has not yet been demonstrated. Environmental issues related to the use of underwater curing epoxies must be considered.

**Future Inspection Requirement:** Basically the same as for a PVC-wrapped pile. Any damage to the fiber wrap, however, could reduce the pile's load bearing capacity.

Figure 6-6 Repair by Oriented Fiber Wraps

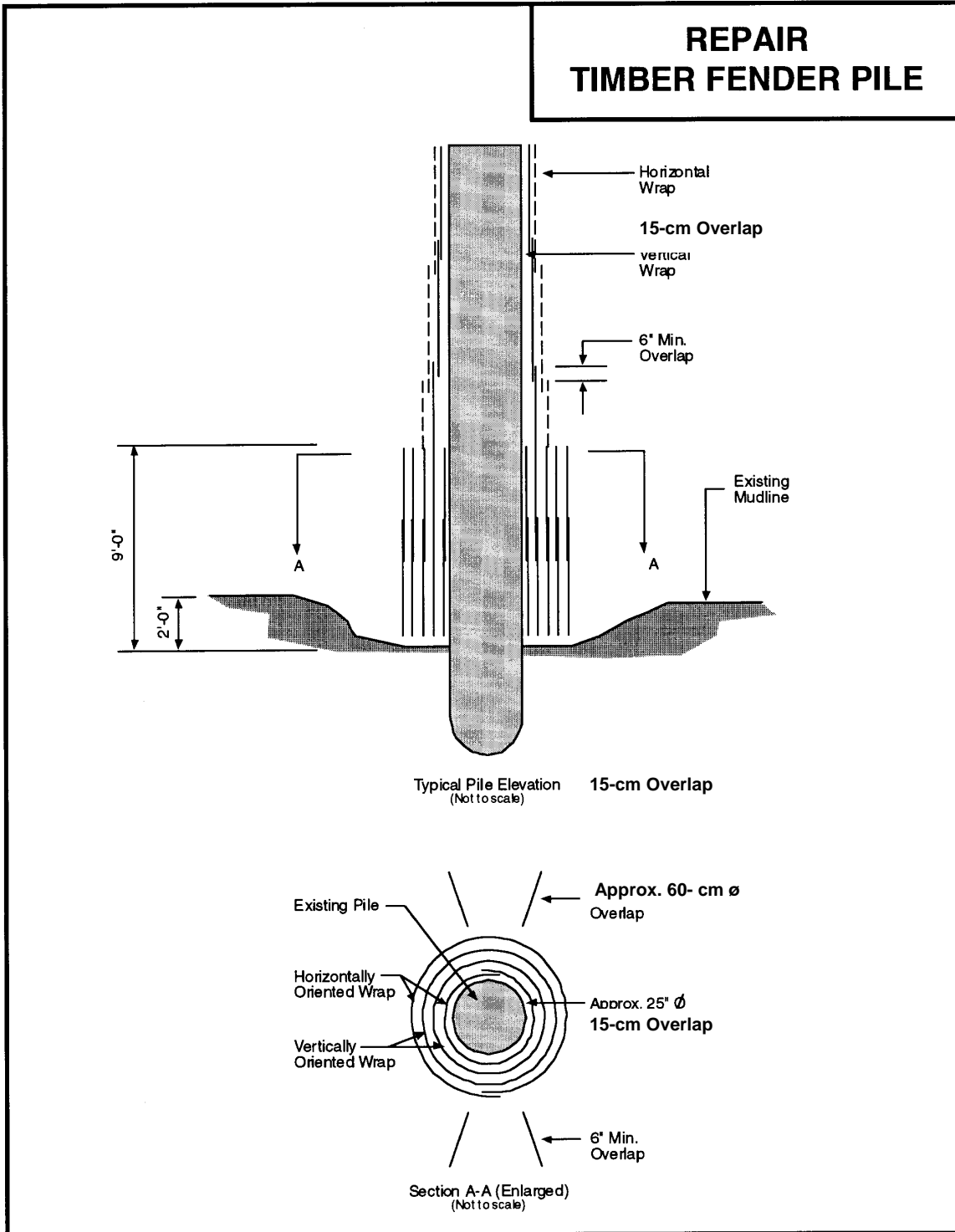

**TR-7: REPLACING DAMAGED PILE WITH NEW TIMBER PILE  
UNDER TIMBER PIER DECK**

**Problem:** Physical damage or severe pile deterioration has been experienced below mudline, and/or a number of piles with severe deterioration (above mudline) is too extensive to maintain structural integrity with partial pile replacement.

**Description of Repair:** Cut an opening in the timber pier deck adjacent to the damaged pile. Drive the new pile and cut to fit under the pile cap. Spring the pile into place (see Figure 6-7). Place shims between the pile and pile cap, then fasten pile to pile cap with a 7/8-inch (22-mm) diameter drift pin.

**Application:** Limited mainly by cost. If fixed structures are on deck, this method may not be cost effective. If damage to the original pile(s) is due to marine borers, remove old pile(s) so that it does not provide bait to attract and nourish more borers. This application can also be used to replace damaged concrete or steel piles.

**Future Inspection Requirement:** Basically the same as for a new pretreated pile.

Figure 6-7 Replacing Damaged Pile with a New Timber Pile

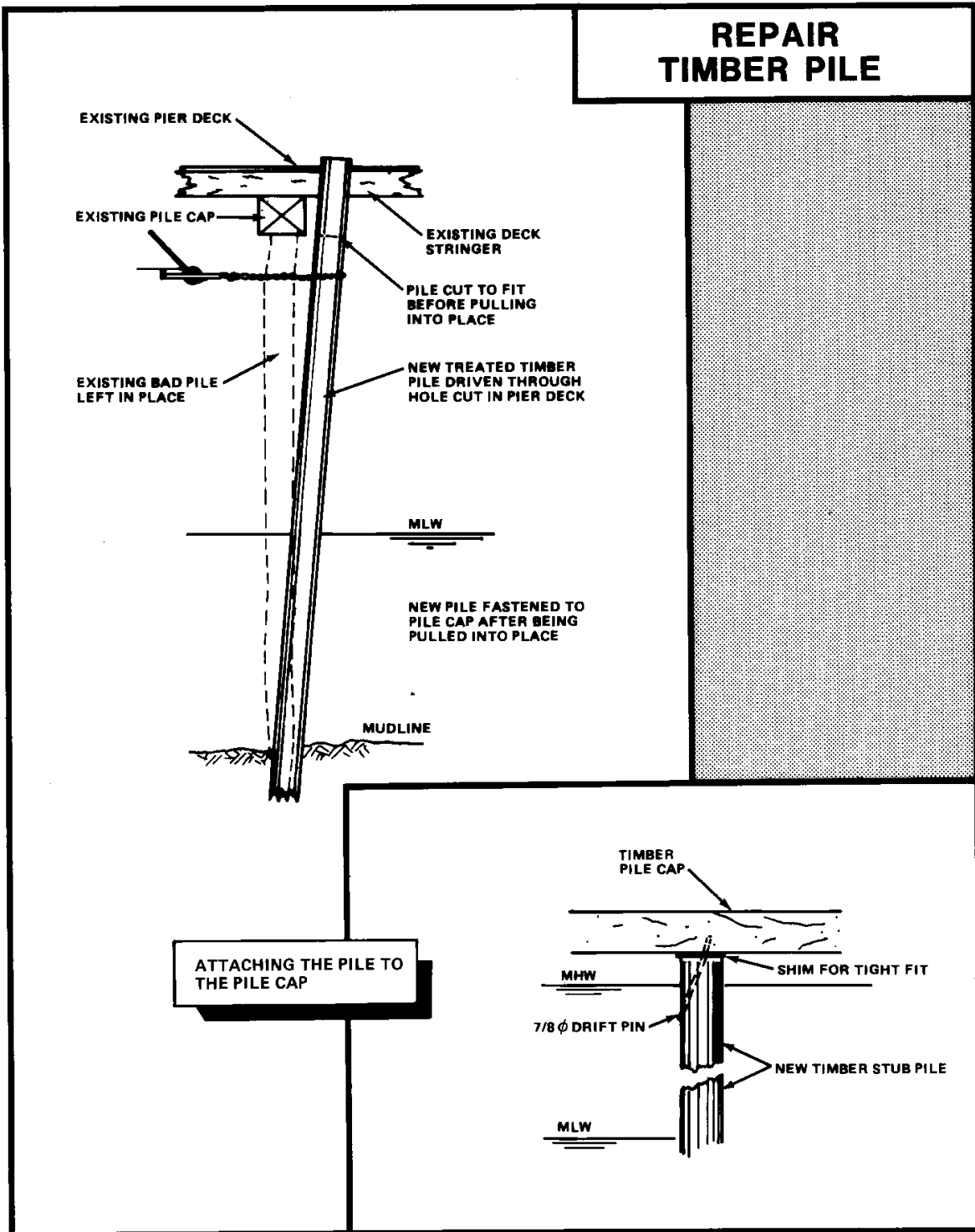

**TR-8: REPLACING DAMAGED PILE WITH NEW CONCRETE PILE  
UNDER CONCRETE DECK**

**Problem:** Pile deterioration or damage has been experienced to significantly reduce the structural integrity of the section of pier. Concrete pile cap and decking precludes replacing with timber pile.

**Description of Repair:** Cut a hole in the concrete deck between timber pile bents. Drive new concrete pile. Cut the pile below the top of the concrete deck. Form the capital under the deck, on top of the new pile. Cast the capital and the new section of concrete deck (see Figure 6-8) including splicing in new reinforcing bars. Epoxy coat bars where possible.

**Application:** Limited, mainly due to cost. If fixed structures are on deck, or if deterioration is wide spread, this approach may not be practical.

**Future Inspection Requirement:** Same as with new concrete piles and concrete deck areas.

Figure 6-8 Replacing a Damaged Timber Pile with a New Concrete Pile under a Concrete Deck

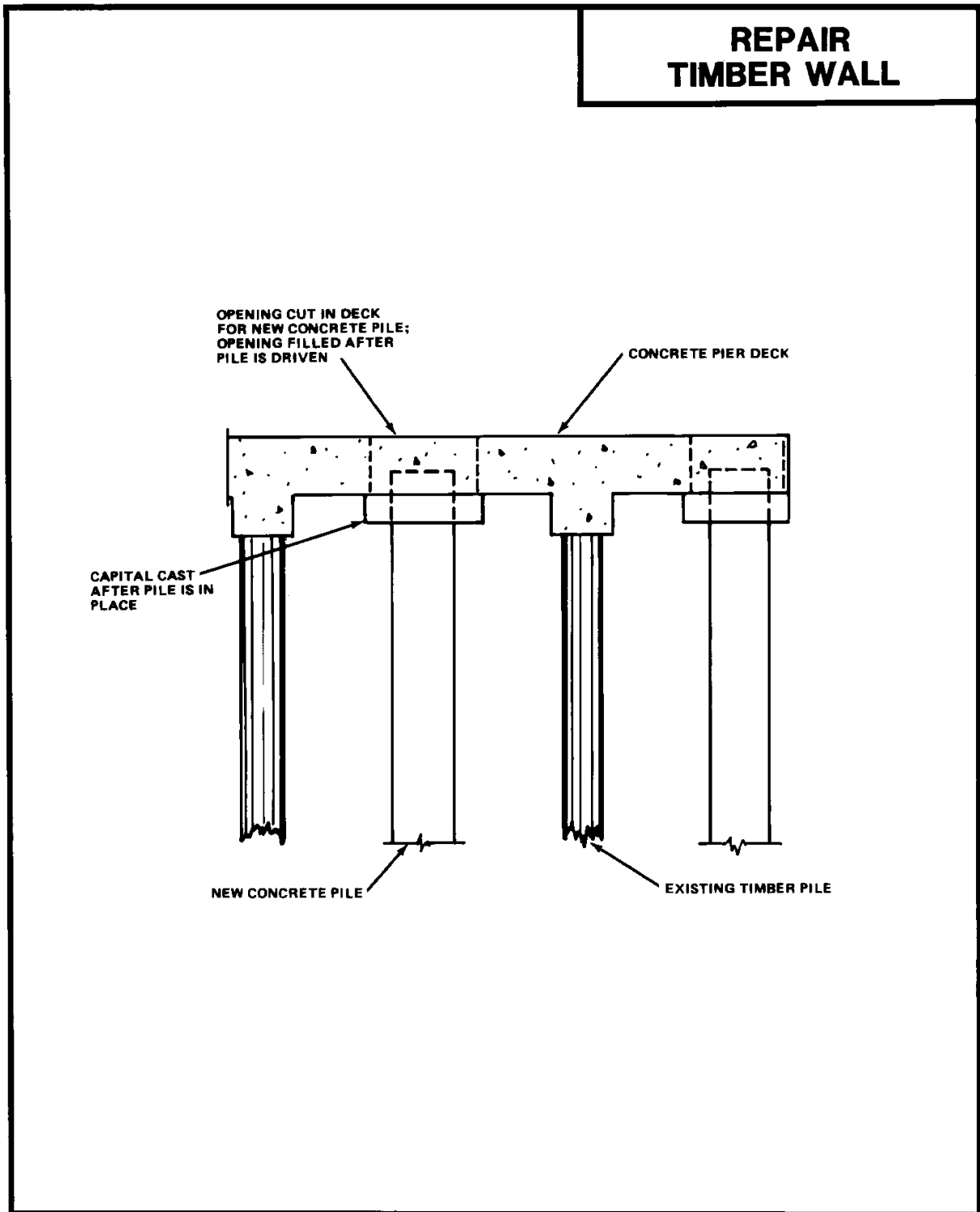

**TR-9: REINFORCING TIE-BACK SYSTEM FOR TIMBER SHEET PILING WALL**

**Problem:** Light to moderate movement of the top of the timber sheetpiling wall has occurred due to tie-back failure or excessive loading behind the wall. The area behind the wall is accessible to perform repairs.

**Description of Repairs:** Install a new wale slightly above the existing wale. Locate the new deadman anchors based on engineering calculations. Trench for the tie rods between the wall and the deadman anchors. Place the tie rods through the wale and sheet piles and secure in place to the deadman anchors (see Figure 6-9). Install zinc or magnesium packaged anodes to prevent further corrosion of the rods.

Replacing an existing tie-back system may involve replacing any or all of the existing components, depending on the amount of deterioration that has taken place.

Sheet pile wall movement can also be arrested by changing the soil load acting on the wall. For example, stone riprap dumped against the exterior toe of the wall will add resistance to the movement of the toe. Alternatively, or in addition, backfill can be removed from behind the wall and replaced with lightweight granular fill. This type of fill frees drains, which reduces the hydrostatic pressure behind the wall and allows the water level on both sides to balance.

**Application:** Reinforcing or replacing the tie-back system may be restricted to correct slight to moderate wall deflection. Excessive deflection may require replacing the wall or major restoration. With timber construction, it is unlikely that excavation and pulling the wall back into position can be done without high risk of failure of the timber members.

**Future Inspection Requirement:** Pay careful attention to wall inspection for further signs of continued deflection or timber member failure.

Figure 6-9 Installing or Replacing Tie-Back System for Timber Sheet Piling Wall

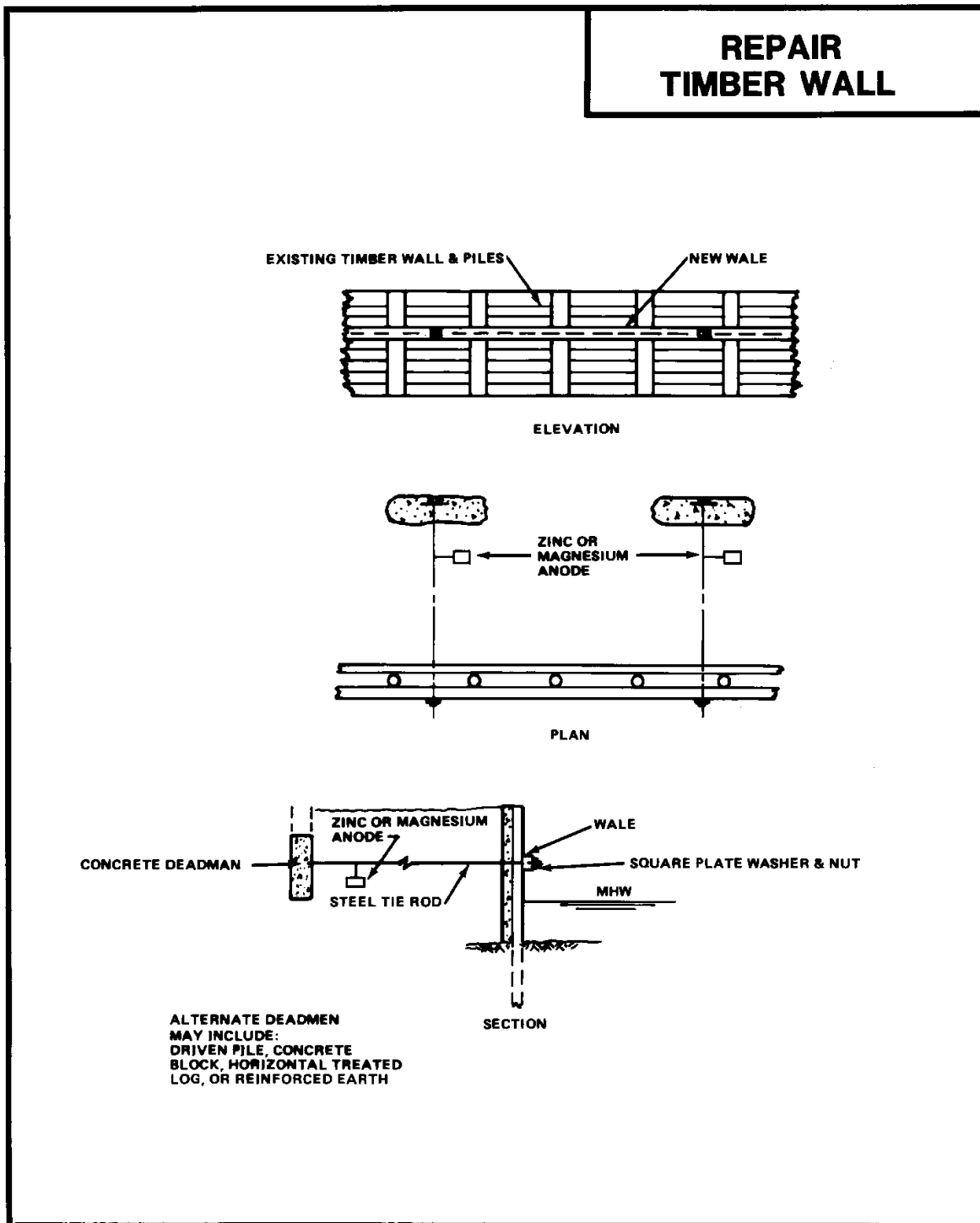



**TR-10: INSTALLING A TIE-BACK SYSTEM ON THE TOP OF A TIMBER SHEET PILING WALL**

**Problem:** The top of the timber sheetpiling wall has moved, lightly to moderately, due to tie-back failure or excessive loading behind the wall. The area behind the wall is inaccessible for repairs.

**Description of Repair:** Cast a new concrete slab with extra reinforcing, from the face of the wall back behind the wall to the end of the existing slab. Tie the front edge of the new slab to wall through use of a steel angle (see Figure 6-10).

**Application:** Limited. Additional restraint is limited to top of sheetpiling. If excessive loading or loss of regular tie-back anchors are experienced, further failure, including shearing of sheetpiling tops, may occur.

**Future Inspection Requirement:** Pay careful attention to wall inspection for further signs of continued deflection or timber member failure.

Figure 6-10 Installing a Tie-Back System at Top of a Timber Sheet Piling Wall

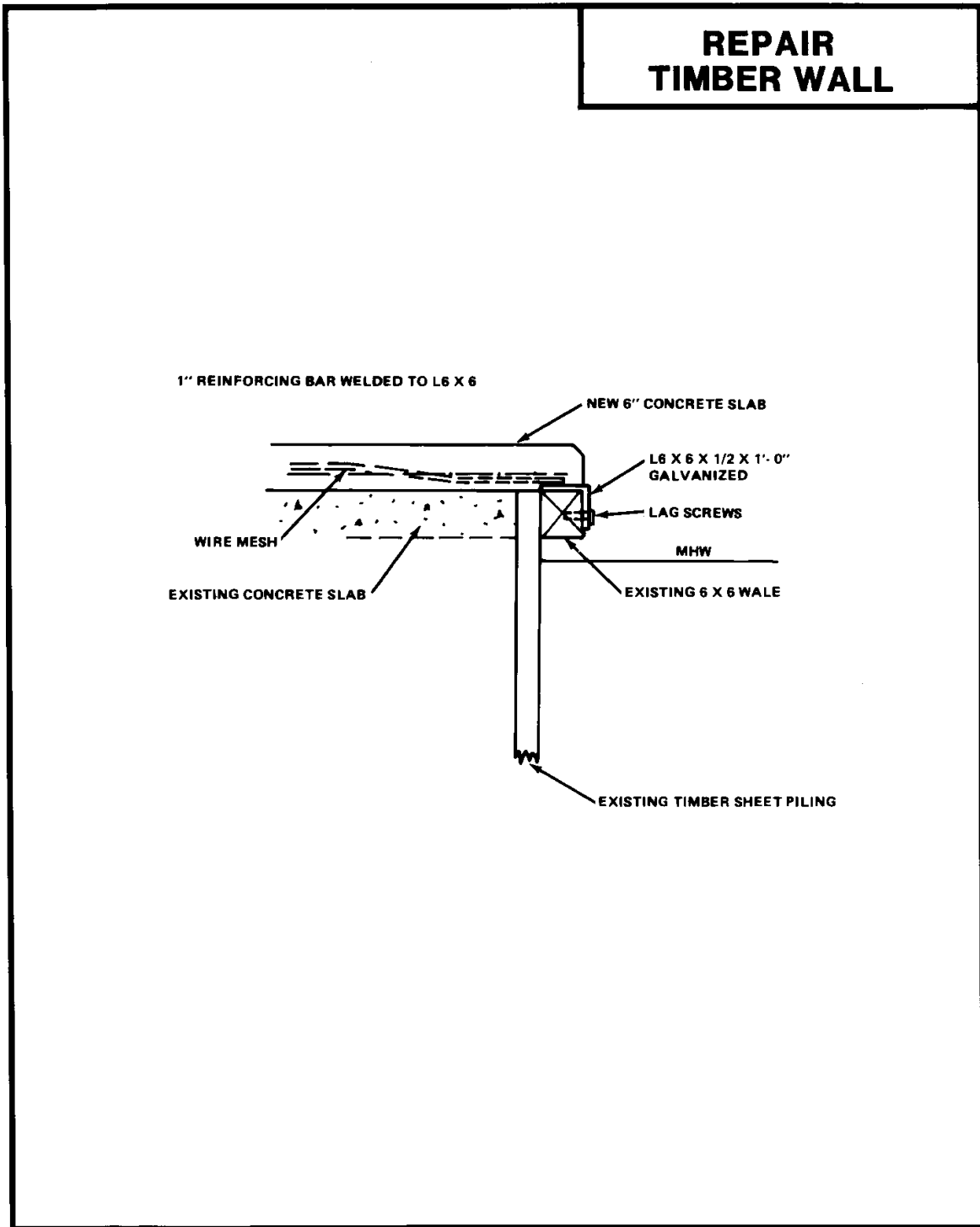

**TR-11: INSTALLING A CONCRETE CAP/FACE ON A TIMBER SHEET  
PILING WALL**

**Problem:** Large-scale deterioration of the timber sheet pile structure has occurred precluding the use of patches for repairs.

**Description of Repairs:** Excavate the soil from behind the wall to a level required for the new concrete cap or attachment of form ties for a concrete face. Remove all marine growth and deteriorated wood, and clean the surfaces.

**To repair a concrete cap**—Build forms, place reinforcing, and pour concrete at MLW. After curing, remove forms and backfill behind the wall (see Figure 6-11).

**To repair a concrete face** -- Place and fasten blocking and low wale against existing sheetpiling. Drive the timber sheet pile wall about 1 foot (30 cm) in front of existing sheetpiling using the wale as a guide. Attach outside wales to timber sheeting and place concrete by pumping or tremie. Leave timber sheet piling in place or remove as desired (see Figure 6-11).

**Application:** Used to restore structural strength at the top of the wall (cap) or prevent further loss of soil through holes in the sheetpiling (face). Does not restore bending moment capacity in wall. Provides protection against further deterioration.

**Future Inspection Requirement:** Do an annual inspection of sheetpiling areas immediately under the pile cap, in order to ensure that fungi, insect, or marine borer damage is not weakening the support for the concrete cap.

Figure 6-11 Installing a Concrete Cap and/or Face on a Timber Sheet Piling Wall

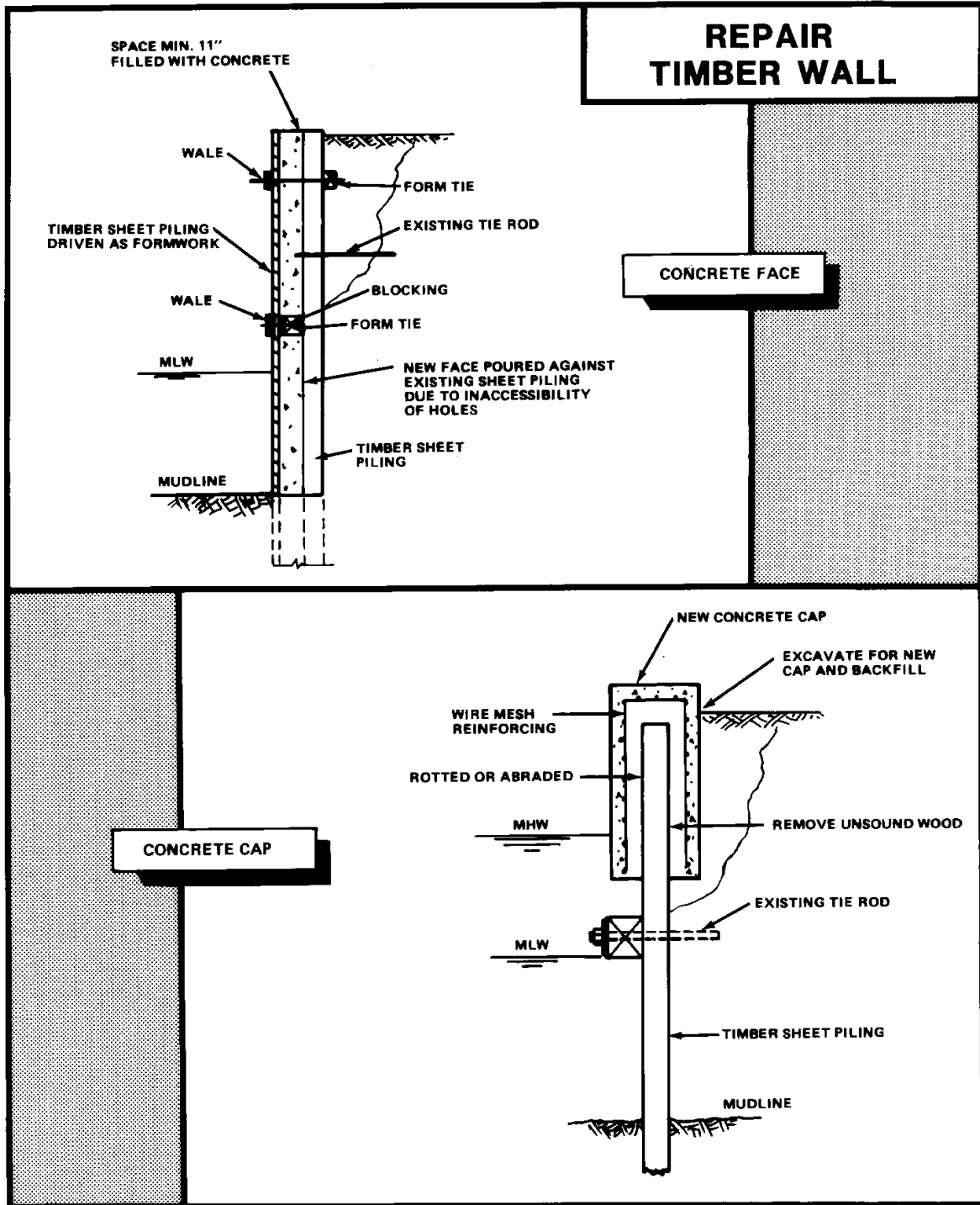

### TR-12: REPLACING DAMAGED DOLPHIN PILE

**Problem:** One or more timber piles are broken or damaged by marine borers and the dolphin can no longer fully serve its purpose.

**Description of Repair:** Before replacing any piles, the fastenings should be removed only as far as is necessary to release the damaged piles. Take care to drive new piles at an angle so that they will not have to be pulled too far to fit them in place. Carefully note the size of piles to be replaced, particularly at the head or intermediate point where they are fitted together with other piles. Trouble cutting and fitting replacement piles can be avoided by selecting piles with the proper size head. Replace and drive all piles before any are brought together. After all the piles are driven, the center cluster should be brought together first, fitted, chocked, bolted, and pinned; when all rows have been properly fitted, etc., wrap with wire rope. All cuts in piles for fittings, bolts, and wrappings should be thoroughly field-treated with creosote. Avoid these cuts as much as possible because field treatment with creosote gives only marginal protection against marine borer attack.

Wrapping the dolphin with PVC may provide protection. See repair technique TR-3.

**Application:** This method is routinely used.

**Future Application Requirements:** Remaining piles should receive special attention.

*This page intentionally left blank.*

## CHAPTER 7

### REPAIR OF CONCRETE STRUCTURES

7-1 **CONCRETE FOR REPAIRS.** Quality, lasting concrete for repair of waterfront facilities depends on the quality of the concrete mix, and careful attention to preparation and construction techniques. Both factors are important in making and placing conventional Portland cement concrete and the special types of repair concretes.

Some of the information in this section was extracted from the following references:

- \1\ UFC 4-151-10, *General Criteria for Waterfront Construction.* /1/
- *Survey of Techniques for Underwater Maintenance/Repair of Waterfront Structures*, Revision No.1, Childs Engineering Corporation, December 1985.
- NCEL TM-43-85-01CR *UCT Conventional Inspection and Repair Techniques Manual*, October 1984.
- CEL CR 81.009, *Survey of Techniques for Underwater Maintenance/Repair of Waterfront Structures*, Childs Engineering Corporation, February 1981.

#### 7-1.1 **Portland Cement Concrete**

##### 7-1.1.1 **Important Properties**

- **Durability.** Concrete of low permeability is important for waterfront facilities. The objective is to keep salt and water out of the concrete to protect the reinforcing steel from corroding, which result in the concrete spalling. The most important factors are a low water-to-cement ratio (0.40) in the mix, use of 25% Class F fly ash, and proper curing of the concrete when placed.
- **Strength.** 5000 psi (35 MPa) concrete is recommended for most repairs. Design of the mix and proper curing will determine the final strength.
- **Workability.** Concrete must be easily handled and placed. A dense concrete is important. This workability must be obtained without increasing the water content beyond the mix design. Enhanced workability is obtained by using 25% Class F fly ash. Use of admixtures conforming to ASTM C494/C494M, *Standard*

*Specification for Chemical Admixtures for Concrete; Types A, D, E, F and G are approved but not required.*

7-1.1.2 **Preparation and Construction.** To obtain quality concrete repairs, the following basics are mandatory for all jobs:

- Properly prepare the surface of the old concrete to be adjoined.
- Ensure a good bond between the old and new concrete.
- Do not add more water than specified for the concrete mix.
- Do not patch across active cracks or joints.
- Cure the concrete properly.

7-1.1.2.1 **Surface Preparation.** All deteriorated concrete must be removed down to sound concrete. For some old concretes, exposed surfaces will soften after a few days of exposure; therefore, the surfaces should be checked closely before patching. Clean the old surface thoroughly just before placing new concrete.

Normally, when removing concrete hand tools or light duty hand-held power tools are used, particularly around the edges, to prevent damaging the remaining concrete. Do not use an impact hammer greater than 15 pound (67 Newtons). Edges should be square, preferably cut by sawing to about a 1 inch (25-mm) depth. Feathered edges must be absolutely avoided. Reinforcing bars should be exposed around their entire circumference by a 1 inch (25-mm) clearance.

Sandblasting surfaces removes loose concrete fragments and scaling rust from steel. Once the steel is clean, protect the coating with a slurry of Portland cement grout or latex modified Portland cement grout. This procedure improves the life of the repair.

7-1.1.2.2 **Bonding.** Before patching, the existing base concrete should be kept damp (except for epoxy concrete repair) for several hours, preferably overnight. Remove free water or shiny wet areas by vacuuming or with oil-free compressed air. Then scrub a bonding agent into the surface with a stiff brush. The bonding agent can be Portland cement mortar or a latex modified Portland cement mortar. Do not use epoxy bonding agents. The mortars should be one-part cement and 1 part sand passing the No. 30 sieve, and have a consistency of thick cream. In all cases, it is important to place the repaired concrete immediately after placing the bonding agent.

7-1.1.2.3 **Curing.** Concrete used in repairs must be protected and cured more carefully than usual. Curing should last for 7 days. The old concrete could absorb



moisture too fast from the new concrete, or the temperature of the old concrete could be too low to permit early development of strength of a concrete patch. Shrinkage of the repair is the most common reason for delamination of the repair from the substrate.

Curing is important to allow strength development and minimize drying shrinkage. For Portland cement mixes, water curing by ponding with water, fog misting, or covering with wet burlap are the best methods. If continuous moisture curing is not possible, then use two applications of a liquid curing compound. The repaired concrete should be kept wet or moist for a minimum of 7 days. When water evaporates from the concrete, drying shrinkage occurs. Shrinkage of a repair patch can cause the patch to crack or partially debond.

Curing for epoxy concrete is to provide the correct temperature for the epoxy resin to develop full strength. Epoxy resins that use 100 percent solids and no solvents do not shrink. Epoxy resins do, however, have a much greater coefficient of expansion than concrete. This often leads to failure in large patches and in environments that experience large temperature differentials between day and night. Epoxy can be mixed with sand (1 part epoxy : 7 parts sand) to minimize the difference in the thermal expansion characteristics.

7-1.1.3 **Guidelines.** General guidelines for concrete used in waterfront repairs include:

- Use 5000 psi (35 MPa) concrete.
- Use only Type I or II.
- Use a minimum of 8.3 bags (360 kg) to a maximum of 10.4 bags (445 kg) of cement per cubic meter in the concrete mix.
- Use a maximum water-cement ratio of 17 L per bag of cement (0.40 by weight).
- For most small volume repairs, use aggregate no larger than 4/5 inch (2 cm).
- Make sure the concrete cover over reinforcing steel is at least 3-1/5 inches (8 cm).

\1\1/

- Pay particular to the use of admixtures: DO NOT use an admixture containing chloride.

- For concrete subject to freeze-thaw cycles, use air-entraining agent to obtain 5 to 7 percent air content.
- Use a water-reducing admixture (ASTM C494/C494M) when concrete is placed in area congested with reinforcing or in pours difficult to consolidate. This will decrease chance of voids and temptation to add water to the concrete.

Specific guidelines for underwater concrete include:

- Water-cement ratio must not exceed 0.40 (5 gallons (19 L) per bag of cement).
- Use a minimum of 10.4 bags (445 kg) to a maximum of 11.25 bags (556 kg) of cement per cubic meter.
- Use an air-entraining admixture to obtain 3 to 6 percent entrained air for improved workability.
- A water-reducing plasticizing admixture may be used to enhance placement and consolidation.

## 7-1.2 **Special Types of Repair Concrete**

7-1.2.1 **Fiber-Reinforced Concrete.** Concrete and mortar containing fibers of steel, glass or polypropylene are sometimes used in repair work. Fiber reinforcement provides improved tensile strength, toughness and ductility to concrete. The fibers reinforce crack repair material by distributing tensile strains.

Fiber-reinforced shotcrete is good to use in marine repair work. In some applications, the fibers can replace steel mesh. Although steel fibers corrode near the surface, in the interior sections they are protected from corrosion by the high alkali of the cement paste. Steel fibers are usually 1/100 to 1/5 inch (0.3 mm to 5 mm) in diameter and 1/2 to 1 3/5 inch (13 to 40 mm) long. The quantity of steel fibers used varies from 6.2 to 18.5 psf (30 to 90 kg/m<sup>2</sup>).

Glass fibers in concrete can lose strength over periods of time in a wet environment and are not recommended. Synthetic fibers reduce crack size due to plastic shrinkage, but should not be the primary reinforcement.

7-1.2.2 **Latex Modified Portland Cement Concrete.** Latex modified Portland cement concrete should not be confused with epoxy or polymer concrete discussed in the Paragraph entitled, "Epoxy Concrete". Latex modifiers improve the bond and tensile strength and reduce the permeability of Portland cement concrete. Latex formulations of acrylics, styrene-butadiene, and polyvinyl acetates are available. The first two latexes are suitable for wet environments.

Polyvinyl acetates should not be used in concrete for repairs exposed to water. Latex modified concrete is recommended for overhead and vertical repairs when placed in lifts less than 1-3/5 inch (4 cm).

Latex modified concrete, compared to epoxy concrete, is vapor permeable and lower in cost. Even though permeable to vapor, it is not very permeable to liquids. Repairs requiring thin sections, which will be exposed to the sun, should be breathable so that vapor pressure does not build up behind the patches or overlays. Vapor pressure can debond and cause a patch to spall off.

Recommended mix proportions for thin and medium thickness repairs are in Table 7-1.

**Table 7-1 Recommended Mix Proportions**

		Finished Thickness
	1/2 to 1 ¼ inch (13 mm to 32 mm)	1 ¼ inch and up (32 mm and up)
Latex to cement ratio	0.10 to 0.20	0.10 to 0.20
Water to cement ratio	0.30 to 0.40	0.30 to 0.40
Fine aggregate to 1 part cement	3.0 to 3.5 parts	2.5 to 3.1 parts
Coarse aggregate to 1 part cement	2.5 to 3.1 parts	1.4 to 2.0 parts

Prepackaged latex modified mortars, or just the liquid latex modifiers, are commercially available. The mortar mixes can be converted to concrete by adding coarse aggregate. Latex modified concretes are sensitive to improper placement techniques, and noted failures have occurred. Carefully follow the manufacturers' recommendations.

**7-1.2.3 Epoxy Concrete.** Epoxy concrete does not contain Portland cement. It is a mixture of an epoxy resin and aggregate. Epoxy concrete is the most popular polymer concrete used because of its many physical properties that can be obtained, good adhesion to existing concrete, and availability. Other commercially available polymers are acrylics, polyesters, polyurethanes, and polyvinyl acetate.

Epoxy resin, when mixed with a curing agent, forms a thermosetting plastic that rapidly develops adhesive strength. Epoxy mixes are used for several purposes:

- To repair cracks by injecting the resin.
- To make epoxy mortar or concrete by mixing the resin with fine and coarse aggregate.

Because the cost is high and the material is inflexible in thick layers, epoxy concrete is used mainly for thin section repairs. Proprietary, prepackaged systems should be used. Generally, the aggregate is a silica sand with little or no material passing the No. 100 sieve (dust). The aggregate must be clean and absolutely dry. Not all epoxy resins will bond to damp or wet concrete, so check the manufacturer's specifications.

Epoxy mortars consist of 1 part epoxy resin to 4 to 7 parts sand by weight. The resin is usually made up of two components that are batched by volume and thoroughly mixed before combined with the aggregate. Epoxy concrete contains 1 part epoxy resin to 6 to 10 parts aggregate by weight. Equal parts of the fine and coarse aggregate are used. Epoxy concrete should be placed in layers no more than 2 inches (5 cm) thick, so that excessive heat build up does not occur. Generally, one should avoid using epoxy mortars because of their high coefficient of thermal expansion that leads to early disbondment of the repair.

7-2 **PLANNING THE REPAIRS.** The first steps in planning a repair will be to:

- Conduct an inspection to determine the course and scope of damage or deterioration.
- Determine operational or functional constraints on the facility because of the needed repair.
- Establish a priority for the repair.

Based on these factors, planning will then proceed to determine if the job should be done in-house or on contract, the repair technique to be used, method of placing the concrete, special skills required, and unique equipment requirements. If underwater repairs are involved, give special attention to planning for the unique requirements, particularly involving safety.

7-2.1 **Seismic Impact of Repairs.** Any concrete repair that alters significantly the mass of a structure may increase seismic vulnerability. A structural analysis by a qualified structural engineer is required to ensure earthquake safety is not compromised by the repair.

7-2.2 **Special Skill Requirements.** Most concrete repair techniques and methods of placement require:

- Normal skills associated with concrete construction
- Building forms
- Setting reinforcing steel
- Mixing concrete
- Vibration
- Finishing
- Curing

Special skills and experience are required for placing shotcrete and for handling and placing concrete for underwater repairs. Shotcrete, in particular, requires a skilled nozzle operator to ensure quality results. Use experienced personnel when using epoxy components, epoxy injection, and sealing cracks and joints require experienced personnel.

Underwater repairs, depending on the complexity of the job, require special skills beyond placing the concrete, such as how to remove marine growth, underwater jetting and blasting, how to use underwater tools for cutting and drilling, and how to use certain materials for coating and caulking underwater.

7-2.3 **Special Equipment Requirements.** Unique equipment requirements exist on many jobs and often dictate the personnel skill requirements. Applying shotcrete requires a complete set of special equipment, as does pumped concrete. See the outlines in concrete placement methods (CPM) CPM-4 and CPM-6. Also, underwater work can require the same equipment listed in the Paragraph entitled, "Equipment Requirements".

Above water repairs require conventional equipment for surface abrasive blasting and air-jet cleaning, form construction, and mixing, placing, and finishing concrete.

7-3 **METHODS OF PLACING CONCRETE AND MORTARS.** The seven most common methods for the placing concrete and mortars in waterfront repair are listed and describer in Table 7-2.

**Table 7-2 Placement of Concrete and Mortar**

No.	Description
CPM-1	Hand Placement
CPM-2	Dry Pack
CPM-3	Cast-in-Place
CPM-4	Shotcrete
CPM-5	Tremie
CPM-6	Pumped
CPM-7	Prepacked

### CPM-1: HAND PLACEMENT

**Description:** Troweling a mortar into shallow, relatively small areas requiring patching.

**Uses:** Patching surface areas small enough for hand work and shallow cavities not suitable for dry pack.

**Materials and Curing:** Take careful measures to minimize drying shrinkage by selecting a material mix design with a maximum allowable shortage of 0.05 percent per ASTM C157/C157M modified and proper curing.

**Preparation:**

- a. Remove all loose and unsound old concrete.
- b. If reinforcing steel is exposed, ensure 1 inch (25 mm) clearance all around and wire brush steel bar.
- c. Thoroughly clean repair area immediately before applying bonding coat.

**Bonding:** Vigorously brush coat repair area with sand-cement slurry: 1 part Type II cement; 1 part sand; and enough water or latex for a consistency of thick cream.

**Mortar Mix:** The proportions of the mix depend on the overall size and depth of the repair, accessibility, and whether the repair is large enough to require coarse aggregate. A typical cement-to-sand ratio is 1:2.5 to 1:3. The water-cement ratio should be no greater than 0.40.

**Placement:**

- a. If repair is in direct sun or wind, build shade/wind break and leave in place during curing period.
- b. Wet the surface of repair area for 24 hours. Do not leave any free water.
- c. Brush coat repair area surface with cement slurry.
- d. Immediately trowel on mortar mixture; completely fill voids and dense placement.

**Curing:** Use wet burlap for 7 days or use a curing compound.

## CPM-2: DRY PACK

**Description:** Packing a stiff mortar into a confined hole or cavity.

**Uses:** Filling narrow slots cut during repair of dormant cracks, and filling cavities/small holes in cross-sectional area that are relatively deep.

### Restrictions/Cautions:

- a. Use for holes no larger than 35 inches<sup>2</sup> (225 cm<sup>2</sup>) in cross-sectional area.
- b. The depth of the cavity should be equal to or greater than the smallest surface dimension.
- c. DO NOT use for:
  1. Shallow depressions where lateral restraint is not obtained.
  2. Filling behind exposed reinforcing steel.
  3. Holes that extend through the structure.
- d. Maintain water content of mortar carefully.

### Preparation:

- a. Thoroughly clean cavity.
- b. Remove all loose or cracked aggregate.
- c. Allow to dry at least 2 days before packing.

**Bonding:** Vigorously brush inside of cavity with a cement slurry: 1 part Type II Portland cement; 1 part clean, dry fine sand; and enough water for a consistency of thick cream.

**Dry Pack Mix:** 1 part cement, 2.5 parts sand passing No. 16 sieve, only enough water so mortar sticks together when squeezed with slight pressure. Take careful measures to minimize drying shrinkage by selecting a material mix design with a maximum allowable shortage of 0.05 percent and proper curing.

### Placement:

- a. Place and compact in layers 2/5 inches (10 mm) thick.
- b. Scratch surface of each layer for good bond of next layer.



- c. Fully compact each layer over entire surface with hardwood stick and hammer.
- d. If a layer becomes rubbery, delay about 30 minutes for mortar to stiffen and then compact.
- e. Finish surface with flat side of stick. Steel tools and water are not recommended.
- f. Patch is usually darker than surrounding concrete. For appearance, use white cement in mix for outside layers.

**Curing:** Use wet burlap for 7 days or use a curing compound.

### CPM-3: CAST-IN-PLACE CONCRETE

**Description:** Placing conventional concrete mix with a concrete mixer truck, chute, bucket, wheel barrows, concrete carts, or shovels.

**Uses:** Use in all repairs where the quantity of concrete required is too large for hand placement, and where special placement methods CPM-4 through CPM-7 are not required. Control of the concrete mix and strength of the completed repair is much better than with any other methods. Should be used when:

- The hole/cavity extends through the concrete section.
- The cavity in un-reinforced concrete is larger than  $139 \frac{1}{2} \text{ in}^2$  ( $900 \text{ cm}^2$ ) in area and over 4 inches (10 cm) deep.
- The cavity in reinforced concrete is over  $69 \frac{3}{4} \text{ in}^2$  ( $450 \text{ cm}^2$ ) in area and deeper than the reinforcing steel.

Major concerns are quality of the mix, good bonding to old surfaces, keeping a low water-cement ratio, and proper curing.

**Restrictions/Cautions:**

- a. Temperature shall be over 40 degrees F (4.5 degrees C) during placement.
- b. Concrete settles after placement, therefore, proper consolidation is essential to prevent cracking

**Preparation:** See concrete repair (CR) procedure CR-3.

- a. Delay several days after demolition of old, deteriorated concrete to confirm the soundness of remaining concrete and excavated surfaces.
- b. Check forms for tightness and stability.
- c. Ensure that old surfaces are cleaned before repairs begin.
- d. Ensure that reinforcing steel is cleaned of rust and scale and exposed at least 1 inch (2.5 cm) all around.

**Bonding:** Usually, a sand-cement grout will suffice. See CR-3 for more information.

**Concrete Mix:** Give particular attention to:

- a. Take careful measures to minimize drying shrinkage by selecting a material mix design with a maximum allowable shortage of 0.05 percent and proper curing.
- b. Consider moisture in aggregate when calculating quantity of water.
- c. Use a water-reducing plasticizer admixture wherever placement and consolidation are restricted, or slumps greater than 4 inches (10 cm) are required.

**Placement:** The equipment used depends on size of the pour, accessibility and working space, and availability of equipment. Concerns are placement speed and consolidation. In confined, hard to access locations, aid consolidation by using admixtures and mechanical vibrators and tampers. Elimination of voids and honeycombing is very important.

**Curing:** The most effective moist-curing method is using wet burlap for 7 days. Do not cut corners or try to economize. This is critical.

#### CPM-4: SHOTCRETE (GUNITE)

**Description:** Sprayed concrete applied directly by an air jet gun. Equipment includes a mechanical feeder, mixer, and compressor. If using a dry-mix, water is added at the nozzle.

**Uses:** Shotcrete is relatively economical where deterioration is shallow and area is large and irregular in shape. Shotcrete requires no form work and thin patches can be made that have a high strength, is an efficient method for vertical and overhead surfaces, and is also used for encasing timber and steel piling.

**Restrictions/Cautions:**

- a. Must have enough repair work to justify the cost of equipment.
- b. Normally restricted to a depth of 4 inches (10 cm) per lift.
- c. Can have a high porosity if improperly applied.
- d. Drying shrinkage rate and thermal expansion can be different than concrete being repaired.
- e. Can have wide variation in application/composition. Quality depends almost entirely on the operator's skill. Follow ACI SP-14 guidelines.

**Preparation:**

- a. Thoroughly remove all defective and loose concrete.
- b. Clean all rust off exposed reinforcing steel.
- c. Roughen all smooth surfaces.
- d. Wire brush or abrasive blast exposed concrete surfaces to be covered.

**Bonding:** A bonding agent is not required.

**Shotcrete Mix:**

- a. Cement-to-aggregate maximum ratio 1 to 3.5. This will result in an in-place mix of about 1 to 2.5 after rebound.
- b. Minimize the water-to-cement ratio.
- c. May use a non-chloride type admixture for rapid setting.

- d. Fiber reinforcing may help minimize shrinkage cracks.

**Placement:**

- a. Install reinforcing wire fabric to ensure the laps project no more than 4/5 inch (20 mm) from surface being covered.
- b. Usually start work at bottom and move up; may follow the tide down.
- c. Fix the profile.
- d. Fill out the area to the original face.
- e. Apply each coat at least 2 inches (5 cm) thick. The final coat should be at least 1/2 inch (13 mm) thick.
- f. Ensure that rebound material is not trapped in corners or edges.
- g. Ensure reinforcing bars are properly encased.

**Curing:** Use wet burlap for 7 days or use a curing compound.

### CPM-5: TREMIE CONCRETE

**Description:** The primary method of placing concrete underwater when gravity flow is adequate. The tremie, a steel tube or rigid hose, runs from a hopper for filling its upper end into the form and is moved vertically as the concrete is placed.

**Uses:** All underwater pours at easily accessible locations that require a quantity of concrete to warrant the equipment set-up.

**Restrictions/Cautions:**

- a. Do not use an aluminum alloy tremie to avoid reaction with the concrete mix.
- b. Location, and space in the form, must be accessible for positioning and moving the tremie vertically and horizontally.
- c. Slump of concrete mix must be carefully controlled within 6 to 8 inches (15 to 20 cm). Too wet a mix may segregate and too dry a mix will not flow properly in the form.
- d. If practicable, place concrete when water temperature is above 50 degrees F (10 degrees C).

**Preparation:** Prepare the repair location in the same manner as cast-in-place concrete. Also, ensure that the tremie pipe is heavy enough to be negatively buoyant, and that the joints in the tremie are well gasketed and sealed. The diameter of the tremie should be at least eight times the largest size aggregate used.

**Bonding:** Not usually required.

**Concrete Mix:**

- a. A typical mix proportion for cement, sand, aggregate, is 1:1.7:2.4 by weight with a water-cement ratio of 0.45.
- b. Use air-entraining and water-reducing plasticizer admixtures as required for the underwater repair. Admixtures conforming to ASTM C494/C494M are acceptable.
- c. Use a mineral admixture of pozzolan in thick sections to control heat buildup. This will reduce amount of cement in the mix.

**Placement:**

- a. Once the tremie pipe is filled, carefully lift the bottom end from the bottom of the form not more than 6 inch (15 cm) to start the flow of concrete.
- b. Placement should be as continuous as possible. The end of the tremie must remain embedded in the concrete by as much as 40 inches (1 meter).
- c. If the tremie is lifted out and the seal is lost, remove it, reseal, and start again.
- d. Move the tremie horizontally while concrete is flowing

**Curing:** Not applicable.

## CPM-6: PUMPED CONCRETE

**Description:** Placing concrete through a pipe or hose using a concrete pump with attached hopper.

**Uses:** Often used for placement above water. May be used for underwater placement in locations with limited accessibility, where the tremie method is not efficient. The advantages for underwater repairs include:

- High quality concrete can be pumped. The mixture must be both workable and cohesive without blocking the pump.
- Workable mixtures containing relatively small coarse aggregate particles provide an easily placed and dense concrete.
- Concrete can be transferred from a barge directly into the forms.
- Pumped concrete fills forms from the bottom upwards, displacing the seawater as more concrete is added.

**Restrictions/Cautions:** See CPM-5, Tremie Concrete. Also:

- a. Carefully control slump of concrete to 6 to 8 inches (15 to 20 cm).
- b. Avoid inclines in the pipe whenever possible.
- c. If delays are encountered, move concrete about 40 inches (1 meter) every 5 minutes. If concrete becomes stiff due to a long delay, discard the mix. Do not retemper by adding water.
- d. Use rubber hose only for discharge end and short pumping distances.

**Preparation:** Prepare the repair location in the same manner as cast-in-place concrete. Also, carefully plan location of pump and routing of pipeline to minimize moves. The pipeline should be horizontal or vertical whenever possible.

**Bonding:** Not usually required underwater; for above water, see CPM-3: Cast-in-Place Concrete.

### Concrete Mix:

- a. A typical mix proportion is 1:3:1 by weight with a water-cement ratio of 0.45. Take careful measures to minimize drying shrinkage by selecting a material mix design with a maximum allowable shortage of 0.05 percent and proper curing.



- b. Use rounded coarse (2/5 inch (10 mm) minimum) aggregate when possible.
- c. Sand should have a higher proportion of finer sizes.
- d. Avoid porous aggregates such as expanded clay, foamed slag, and pumice.

**Placement:** The principles of placing tremie concrete apply. Also:

- a. Before filling hopper, lubricate the pipe with water, then a cement-water slurry.
- b. Take all precautions to avoid separation of the mix.
- c. Always keep discharge buried in the fresh concrete.
- d. Control discharge to keep lateral flow of concrete within 0.7 to 1 meter.

**Curing:** Not applicable underwater. If above water, use wet burlap for 7 days or use a curing compound.

## CPM-7: PREPACKED CONCRETE

**Description:** Placing coarse aggregate in the form and filling the voids with grout. It is used on large repair jobs, and usually grout is pumped through grout pipes from the bottom up.

**Uses:** Prepacked concrete is used where placement of cast-in-place concrete is not practical. It is also used underwater where the tremie or pumped methods are not practical due to inaccessibility. It is suitable for vertical surface repairs that have a minimum thickness of 3 to 4 inches (8 to 10 cm).

### **Restrictions/Cautions:**

- Prior to injecting grout, be sure fines have not collected in the coarse aggregate. Fines in the aggregate can impede the flow of grout and create voids.
- Protect the aggregate from contamination after it is placed.

**Preparation:** Prepare the repair location in the same manner as for cast-in-place concrete. Also, ensure grout pipes are well installed and fixed to forms or reinforcing. A vent must be provided at the highest point.

**Bonding:** Not required.

**Concrete Mix:** Take careful measures to minimize drying shrinkage by selecting a material mix design with a maximum allowable shortage of 0.05 percent and proper curing. Coarse aggregate is sized to the size of repair. The sand-cement grout is usually richer than a 1:1 mix. Admixtures are used as required by the circumstances. Usually, a chemical admixture is used as an intrusion aid for the grout. This suspends solids and provides fluidity. An air-entraining admixture is used to obtain about 9 percent air in the grout.

**Placement:** Pump the grout soon after the aggregate is placed. Ensure that all voids are filled and that segregation in layers does not take place. When forms are filled, apply a closing pressure of about 14.5 psi (0.1 MPa) to drive out air and water through the vent.

**Curing:** Use wet burlap for 7 days or a curing compound.

7-4        **CONCRETE REPAIR PROCEDURES.** Figure 7-1 summarizes the general steps taken in concrete repairs. The more standard repair procedures and techniques used for waterfront facilities are listed in Table 7-3 and included in the following pages. These repair techniques should be used in conjunction with the guidelines for concrete in the Paragraph entitled, "Concrete for Repairs", the descriptions of methods of placement in the Paragraph entitled, "Methods of Placing Concrete and Mortars" and the preservation measures outlined in Chapter 3.

**Table 7-3 Repair Techniques for Concrete Structures**

No.	Description
CR-1	Repair Small to Medium Cracks by Epoxy Grout Injection
CR-2	Major Joint and Crack Repair
CR-3	Repairs to Concrete Seawall
CR-4	Miscellaneous Repairs to Concrete Piles
CR-5	Concrete Jacketing of Concrete Piles
CR-6	Typical Combination Repair: Cast-in-Place Concrete and Epoxy Grout Injection
CR-7	Typical Repair Using Polymer Concrete
CR-8	Typical Concrete Wall Repair

Figure 7-1 General Steps to Concrete Repair

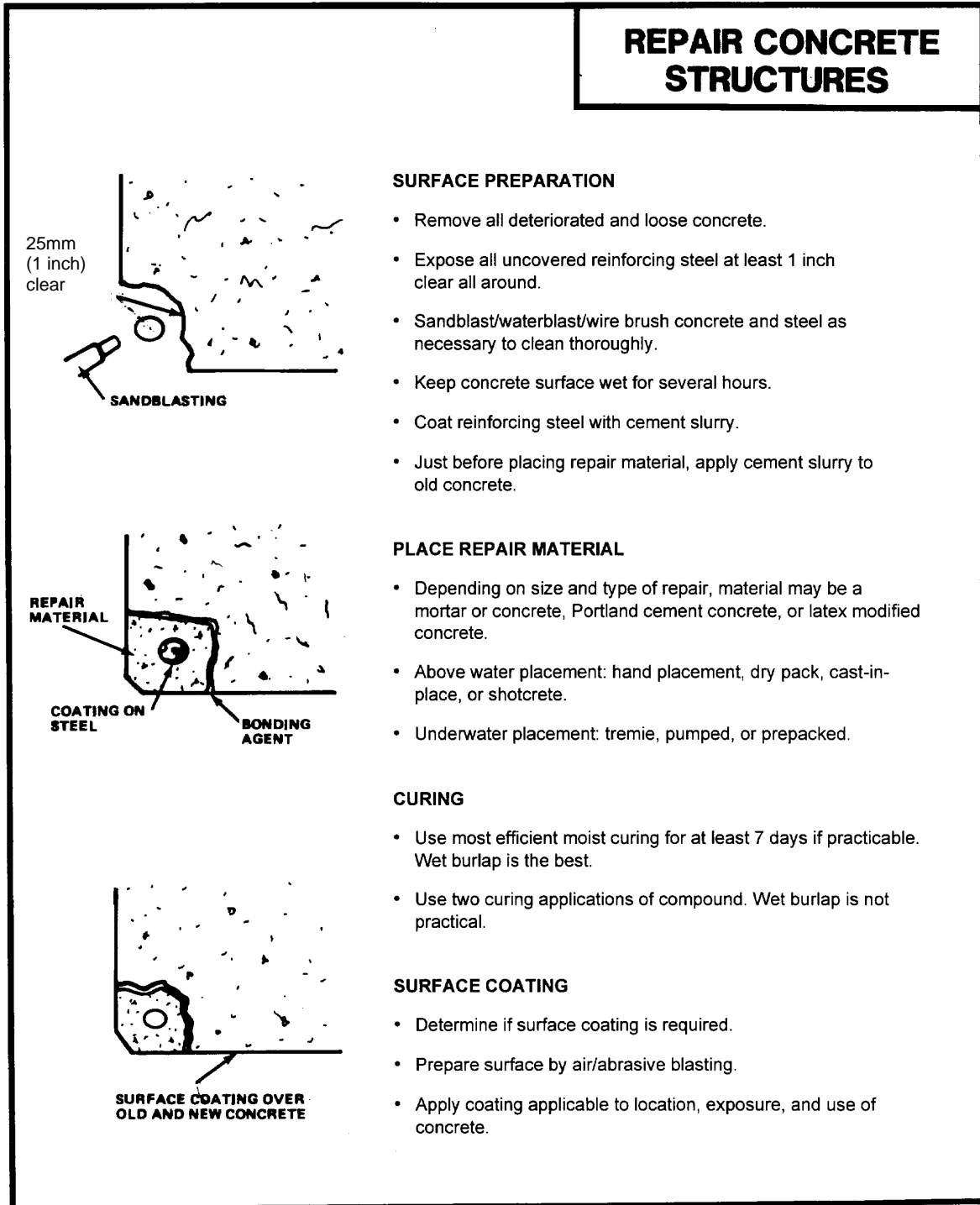

## CR-1: REPAIR SMALL TO MEDIUM CRACKS BY EPOXY GROUT INJECTION

**Problem:** Cracks caused by weathering, deterioration, or reinforcing steel corrosion allow water to penetrate the structure.

**Description of Repairs:** Filling and sealing small to medium cracks by injecting a low-viscosity urethane and sealing the outside with an epoxy paste. Routing and cleaning of cracks are performed with conventional hand and power tools. Injection for smaller jobs can be done with a hand-operated caulking gun. Large jobs are usually done with special equipment.

### Materials:

a. Low-Viscosity Epoxy - Select a urethane suitable for wet surfaces and underwater application that is compatible with crack volume, crack movement, and equipment to be used for injection.

Sealing Epoxy - Use a quick-setting epoxy paste adhesive suitable for underwater application that has good bonding characteristics for concrete being repaired.

### Preparation:

- a. Rout out cracks to remove all deteriorated and loose concrete and aggregate. Clean area to receive sealing epoxy with wire brush, high-pressure water jet, or sandblasting.
- b. Drill injection holes every 6 inches (15 cm) along the length of the crack for larger jobs with deep cracks. Install a tube or one-way polyethylene valve in the holes as injection ports.
- c. Repair small and shallow cracks with a hand gun, injection ports may be openings left in the sealing epoxy every 6 inches (15 cm).

**Repair Procedures:** See Figure 7-2.

- a. Perform repairs when ambient/water temperature is at least 50 degrees F (10 degrees C).
- b. Seal the outside surface of the crack with the epoxy paste, carefully sealing around the injection ports.
- c. After the surface seal has set, inject the urethane grout, starting at the bottom port for a vertical crack. Continue injection until grout shows in the next port then continue up the crack until the entire crack is filled.
- d. Plug the port holes with the sealing epoxy paste.

**Application:** Epoxy grout injection does not stop spalling due to rebar corrosion. This method is most useful in making structural repairs of cracked concrete that is static only. Cured epoxy is rigid, therefore, epoxy injection is not recommended where there is any additional cracking or movement of concrete anticipated. Follow International Concrete Repair Institute (ICRI) Technical Guide \1\ No. 210.1, Guide for Verifying Field Performance of Epoxy Injection of Concrete Cracks (formerly No. 03734) /1/.

Figure 7-2 Typical Crack Repair with Epoxy Grout Injection

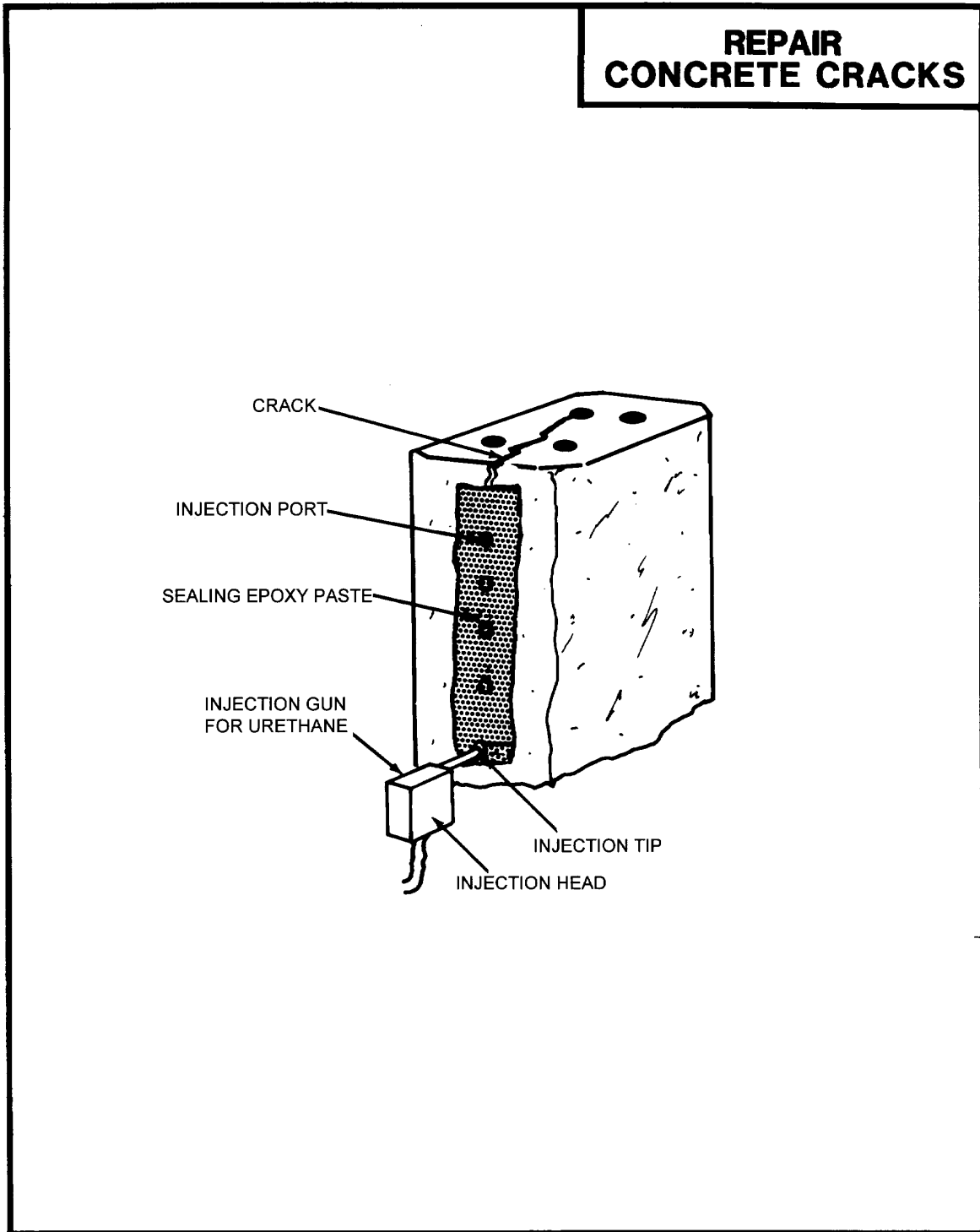

## CR-2: MAJOR JOINT AND CRACK REPAIR

**Problem:** Large cracks or construction joints allow water to penetrate in or leak through the structure.

**Description of Repairs:** Sealing of cracks and construction joints to prevent leakage. This repair is performed after grouting of cracks is completed. Example given is for drainage and discharge tunnels, and should be modified for less demanding applications. Repair requires conventional hand and power tools and a heating bucket.

### Materials:

- a. Sealant No. 1 - Two-component epoxy coating system. See \1\1/ CR-4, Applications.
- b. Sealant No. 2 - Non-meltable mastic of refined asphalts, resins, and plasticized compounds reinforced with non-asbestos fiber. Resistant to seawater, salts, acids, and dilute alkalis.
- c. Primer for Sealant No. 2 - Asphaltic liquid primer compatible with sealant.
- d. Sealant No. 3 - Two-component, moisture insensitive epoxy resin mortar; 1 part mixed epoxy to 7 parts aggregate by volume.
- e. Copper Plate - 16 gauge conforming to ASTM B370, *Copper Sheet and Strip for Building Construction*.

**Preparation:** Chip out and saw cut concrete as shown on Figure 7-3. Clean all surfaces to receive sealants of all loose and deteriorated concrete and marine growth by chipping, scraping, and sandblasting. Provide clean, sound bond surfaces. Prepare surfaces to meet sealant manufacturer's requirements.

### Repair Procedures:

- a. Perform repairs when ambient or water temperature is at least 50 degrees F (10 degrees C), depending on whether structure is exposed or submerged.
- b. Apply Sealant No. 1 with a brush to cleaned surfaces.
- c. Prime all surfaces to receive sealant No. 2 with primer and let dry.
- d. Apply three layers of Sealant No. 2 (heat sealant) as shown in Figure 7-3. Pound each layer during and after cooling.



- e. Fasten copper strip in place for placement of sealant No. 3. Do not use fasteners of dissimilar metal.
- f. Apply sealant No. 3 as shown and tool the joint as required.  
Curing: Cure sealants per manufacturer's specifications.

Figure 7-3. Joint and crack repair

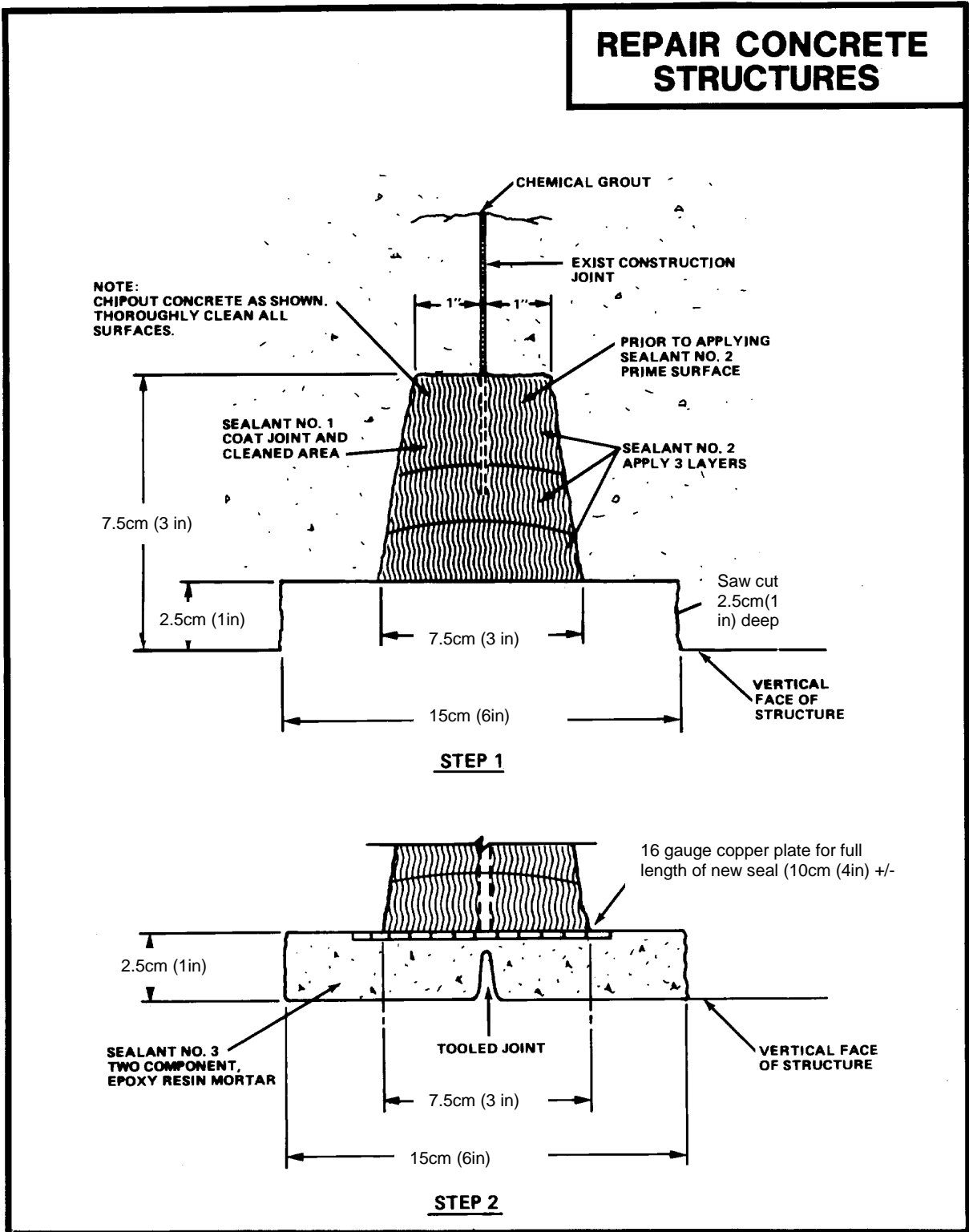

### CR-3: REPAIRS TO CONCRETE SEAWALL

**Problem:** Sulphate attack has caused limited disintegration of the seawall within the tidal zone.

**Description of Repairs:** Contact between the existing concrete and seawater is eliminated by adding a repair layer of sulphate-resisting concrete. Old concrete is replaced only to the extent necessary to repair damage and to isolate the old concrete from the seawater reaction. See Figure 7-4.

Repair procedures are as described in CPM-3 for cast-in-place concrete or CPM-5 if the tremie method is required. Also, see repair CR-8 for certain applicable procedures.

- Type "A" Repair: In this case, a minimum of 7 7/8 inch (20 cm) of the existing wall thickness must be sound concrete. A fascia of new concrete is added, well anchored to the existing wall.
- Type "B" Repair: In this case, a section of the wall is replaced, through its entire width, which includes the fascia on the water side. This type of repair uses the dry pack method, CPM-2, to close the gap between the top of the new concrete and the existing concrete. See CR-8 and Figure 7-7 for a similar wall repair.

**Application:** These types of repair are applicable where the extent of the deterioration is limited and is not threatening to the entire height of the seawall, and a partial repair from foundation to above high water will solve the problem. The wall foundation must be in good condition. Extensive deterioration along a length of the seawall would call for a complete demolition and replacement of a section of wall.

Figure 7-4 Repairs to Concrete Seawall

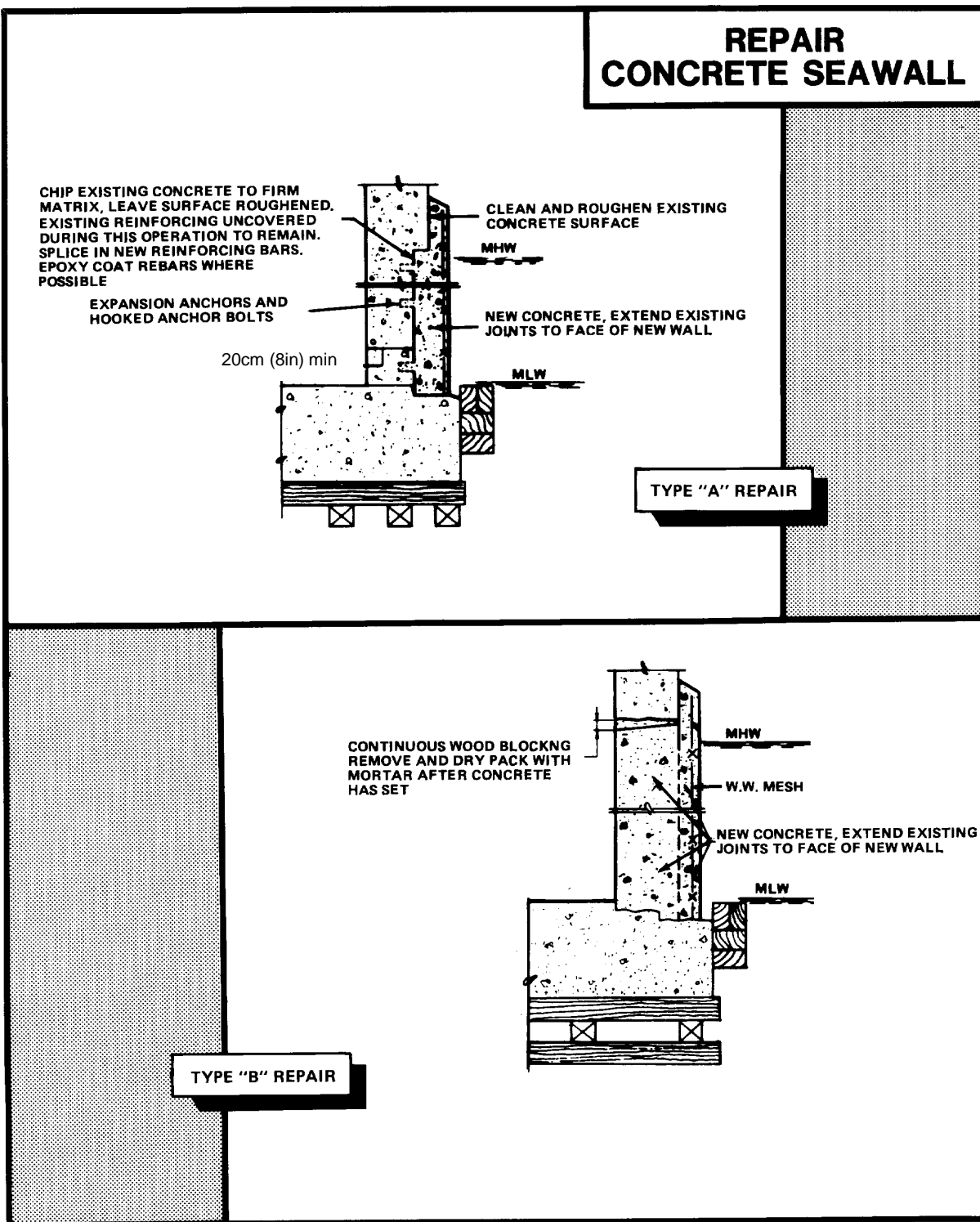

#### CR-4: MISCELLANEOUS REPAIRS TO CONCRETE PILES

**Problem:** Concrete pile is worn from abrasion at waterline; has spalled areas above the tidal zone; or is badly cracked.

**Description of Repairs:** In all cases, the repair area must be cleaned thoroughly of marine growth. All loose and deteriorated concrete must be removed. If reinforcing steel is exposed, it must be cleaned of all rust and scale and exposed at least 1 inch (2.5 cm) clear all around.

Figure 7-5 illustrates:

- Concrete Jacketing:
  - a. Wrap pile with spiral reinforcing length of jacket.
  - b. Place form around pile (metal, fiberglass, fiber, or other material).
  - c. Fill form with 5000 psi (35 MPa) concrete, either pumped or placed with a tremie (see CPM-5 and CPM-6).
  - d. Form may be removed or left in place.
- Patch Spalled Areas: Repair the spalled areas by hand (see CPM-1) or form and pour.
- Fill Crack with Urethane Grout: See repair CR-1.

**Applications:** The concrete jacketing repair is a partial restoration when the pile is worn/deteriorated only in the tidal zone and sound below and above water. See repair CR-5 for more complete concrete pile restoration.

The spall patching and crack filling repairs are relatively minor, inexpensive techniques to protect the reinforcing steel from seawater. The effectiveness of the spall patches depend on the bond that is obtained with the old concrete and the corrosion activity on-going in the rebar in the substrate.

Figure 7-5 Miscellaneous Repairs to Concrete Piles

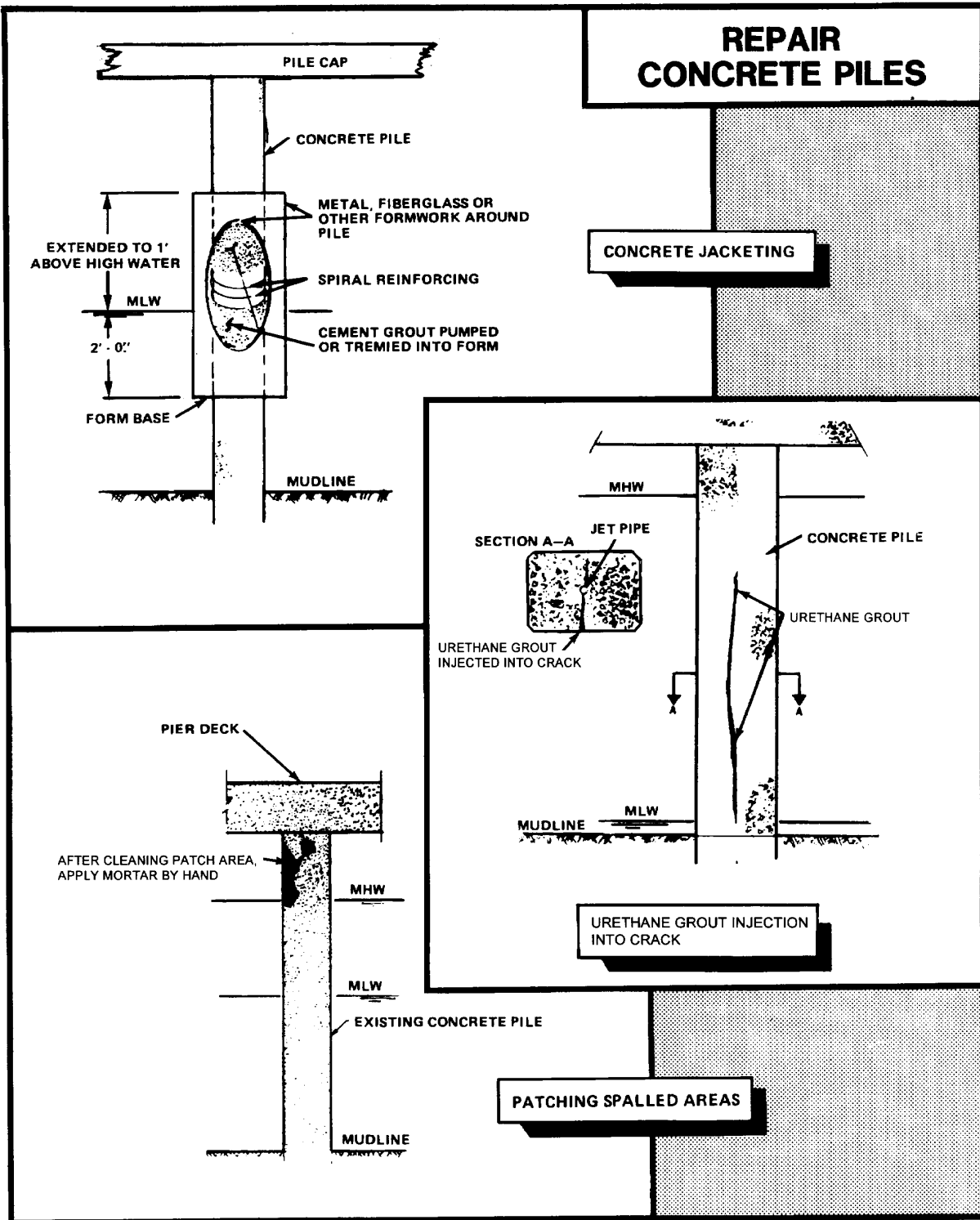

### CR-5: CONCRETE JACKETING OF CONCRETE PILE

**Problem:** Precast concrete piles have major deterioration due to sulphate attack. Deterioration extends to the mud line.

**Description of Repairs:** See Figure 7-6. In this example, the original pile section was 15  $\frac{3}{4}$  inches (40 cm) square. The concrete jacket, as shown, is 30 inches (76 cm) in diameter. A timber encasement, with galvanized steel bands, is used in the tidal zone. A corrugated sheet metal form is used down below the mud line. See CPM-6 for the pumped concrete method of injecting the new concrete. Figure 7-6 shows the top portion of the pile encased with either a pneumatically placed (CPM-4) or hand-placed grout (CPM-1).

**Applications:** This method is applicable when the remaining section of pile is structurally sound and judged to be worth saving. Jacketing versus complete replacement is an economic decision.

Figure 7-6 Jacketing Concrete Piles

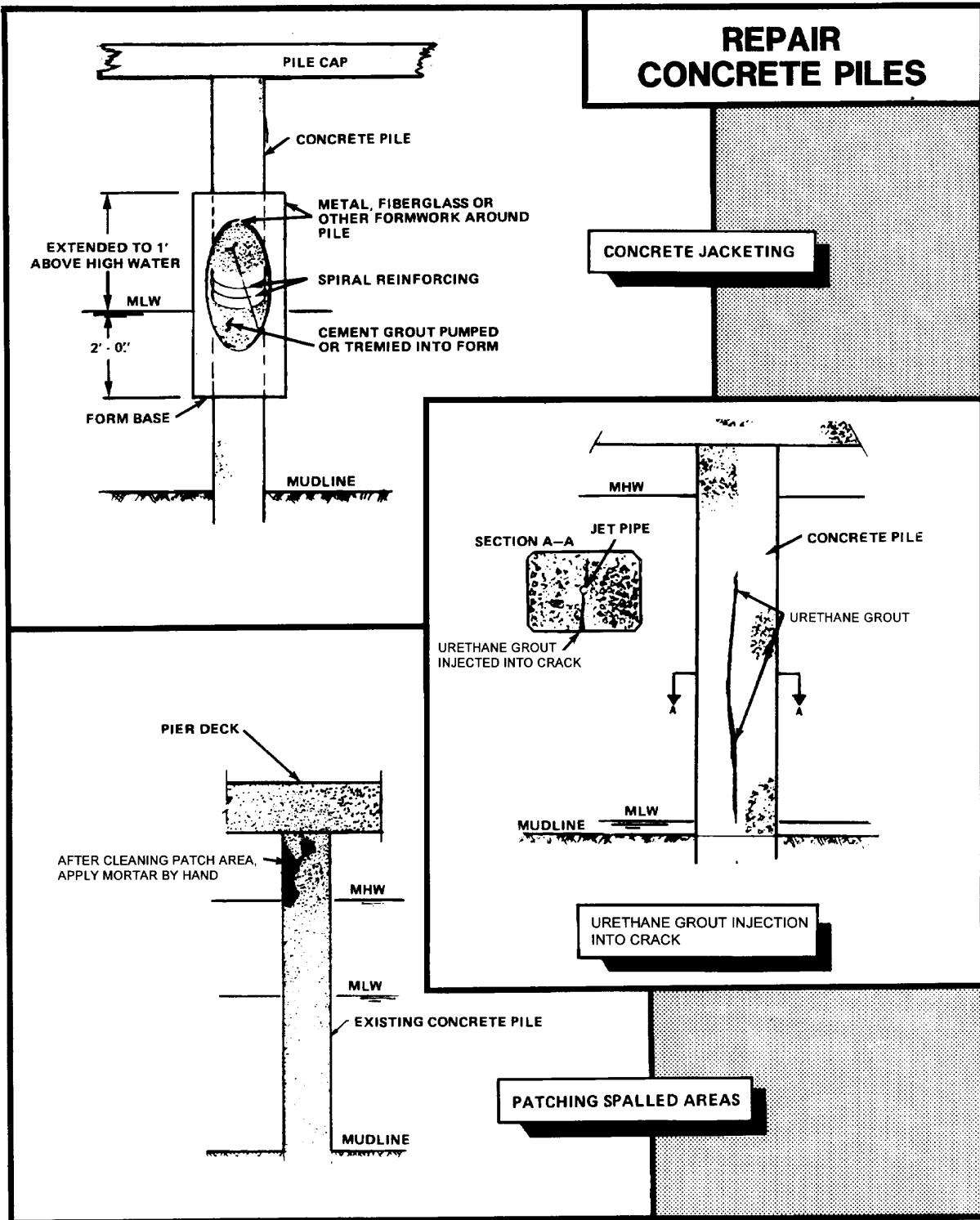



## **CR-6: COMBINATION REPAIR CAST-IN-PLACE CONCRETE AND EPOXY GROUT INJECTION**

**Problem:** Concrete footings with many cracks with some spalling, scaling, and delaminated areas.

**Description of Repairs:** Repair footings using a combination of restoration with Portland cement concrete, and filling cracks and delaminated concrete by injecting urethane resin. Tools required: air hammer, conventional hand and power tools, and injection gun or pump for urethane.

### **Materials:**

- a. Portland cement concrete.
- b. Urethane resin for injection.

### **Preparation:**

- a. Remove all unsound concrete.
- b. Wire brush or sandblast all surfaces to receive bonding agent and clean thoroughly.
- c. Thoroughly clean and coat any exposed reinforcing steel with cement slurry.
- d. Sound concrete with metal rod to determine extent of delamination and outline the areas.
- e. After restoration of concrete is completed, rout and clean racks to be filled with injected urethane.

### **Repair Procedures:**

- a. Place, cure, and finish concrete repairs to restore structure to its original shape (CPM-3).
- b. Select epoxy injection points and drill holes if required. Insert injection tubes or valves if required. See repair CR-1.
- c. Fill cracks 3.1 mils (0.08 mm) wide and larger, and delaminated areas, by injecting the low-viscosity urethane. For jobs with large areas of delamination and deep cracks, pressures up to 1,000 psi (6.9 MPa) may be required.
- d. Plug the injection holes with epoxy paste.

### CR-7: REPAIR USING POLYMER CONCRETE

**Problem:** Concrete roof deck spalling due to corrosion of reinforcing steel and cracks around support columns.

**Description of Repairs:** Patch spalled areas with PCC mortar. Coat roof deck. Reseal joints with polyurethane joint sealer. Requires conventional hand and power tools. May not be suitable for vehicle traffic areas.

**Materials:** Take careful measures to minimize drying shrinkage by selecting a material mix design with a maximum allowable shortage of 0.05 percent and proper curing.

- a. Latex modified portland cement.
- b. Polyurethane joint sealant that meets ASTM C920, *Specification for Elastomeric Joint Sealants*.

#### **Preparation:**

- a. Remove all unsound concrete in the spalled areas. Expose reinforcing steel all around.
- b. Clean the exposed reinforcing steel and entire deck area by sandblasting.
- c. Thoroughly clean areas to receive new material immediately prior to placement.

#### **Repair Procedures:**

- a. Patch spalled areas with Latex Modified Concrete.
- b. Seal entire deck area with neat polyester resin.
- c. Remove all joint sealant and reseal joints.

**Limitations:** The corrosion processes will continue to cause cracks and delaminations.

## CR-8: TYPICAL CONCRETE WALL REPAIR

**Problem:** Holes or severely deteriorated areas require replacing the wall section with cast-in-place concrete.

**Description of Repairs:** Defective section of wall is removed, surfaces and reinforcing steel are prepared, form work built, and wall is restored with cast-in-place concrete. Repair may be an internal section, as shown in Figure 7-7, or may be the top of a wall or pier deck curb requiring an open-top form. Equipment used includes: sandblasting and air-water jet cleaning equipment, concrete saw, air chipping hammer, air-suction gun for mortar if available, power vibrator and tamper, and conventional concrete placement tools.

**Materials:** Portland cement concrete with maximum shrinkage of 0.05 percent.

### Preparation:

- a. Use air hammer or hand tools to remove all unsound concrete to the limits of the repair area.
- b. Cut the top edge of the hole at the face of the structure to a fairly horizontal line (see Figure 7-7). Where a hole passes through a structural element, it may be necessary to fill the hole from both sides. In this case the slope of the top of the cut should be modified accordingly.
- c. Cut the bottom and sides of the hole sharp and square with the face of the wall. When the hole goes entirely through the concrete section, spalling and feather edges can be avoided by having chippers work from both faces. All interior corners should be rounded to a minimum radius of 1 inch (25 mm).
- d. Do not leave reinforcing steel partially embedded. Ensure there is a minimum of a 1 inch (25 mm) clearance around each exposed bar. Remove unnecessary tie wires.
- e. Clean all surfaces to bond to new concrete with wet sandblasting and air-water jet. Clean exposed steel with abrasive blasting or wire brushing.

### Repair Procedures:

- a. Construct front forms for patches more than 18 inches (46 cm) high in horizontal sections so the concrete can be placed in lifts not more than 1 foot (30 cm) high. The back form can be built in one piece. Sections to be set as concreting progresses should be fitted before concrete placement is started. See Figure 7-7.

- b. For irregularly shaped holes, chimneys (accesses) may be required at more than one level. In some cases, such as when beam connections are involved, a chimney may be needed on both sides of the wall or beam. In all cases, the chimney should extend the full width of the hole.
- c. Ensure forms are constructed so that pressure can be applied to the chimney cap at the proper time.
- d. Ensure forms are mortar tight at all joints between adjacent sections, between the forms and concrete, and at the tie-bolt holes to prevent the loss of mortar when pressure is applied to the concrete during the final states of placement. Place twisted or stranded caulking cotton, folded canvas strips, or similar material between the joints as the forms are built.
- e. Keep concrete surfaces wet for several hours, preferably overnight, before placement.
- f. Before placing the front section of form for each lift, coat the surface of the old concrete with a 118 mils (3-mm) thick layer of mortar. This mortar should have the same sand and cement content and the same water-cement ratio as the new concrete. The surface should be damp, but not wet. The mortar can be applied with an air-suction gun, brush, or rubbed into the surface by hand. (Be sure worker is wearing rubber gloves if doing by hand.)
- g. Place concrete immediately. Ensure thorough compaction by vibration or pressure grouting to 14.5 psi (0.1 MPa).
- h. Remove forms the day after placement. If chimneys were used, remove the remaining projections the second day working up from the bottom.
- i. Thoroughly moist-cure the new concrete.
- j. Finish with a wood float. Tool or chamfer edges and corners as required. Avoid using water in finishing.

Figure 7-7 Typical Concrete Wall Repair

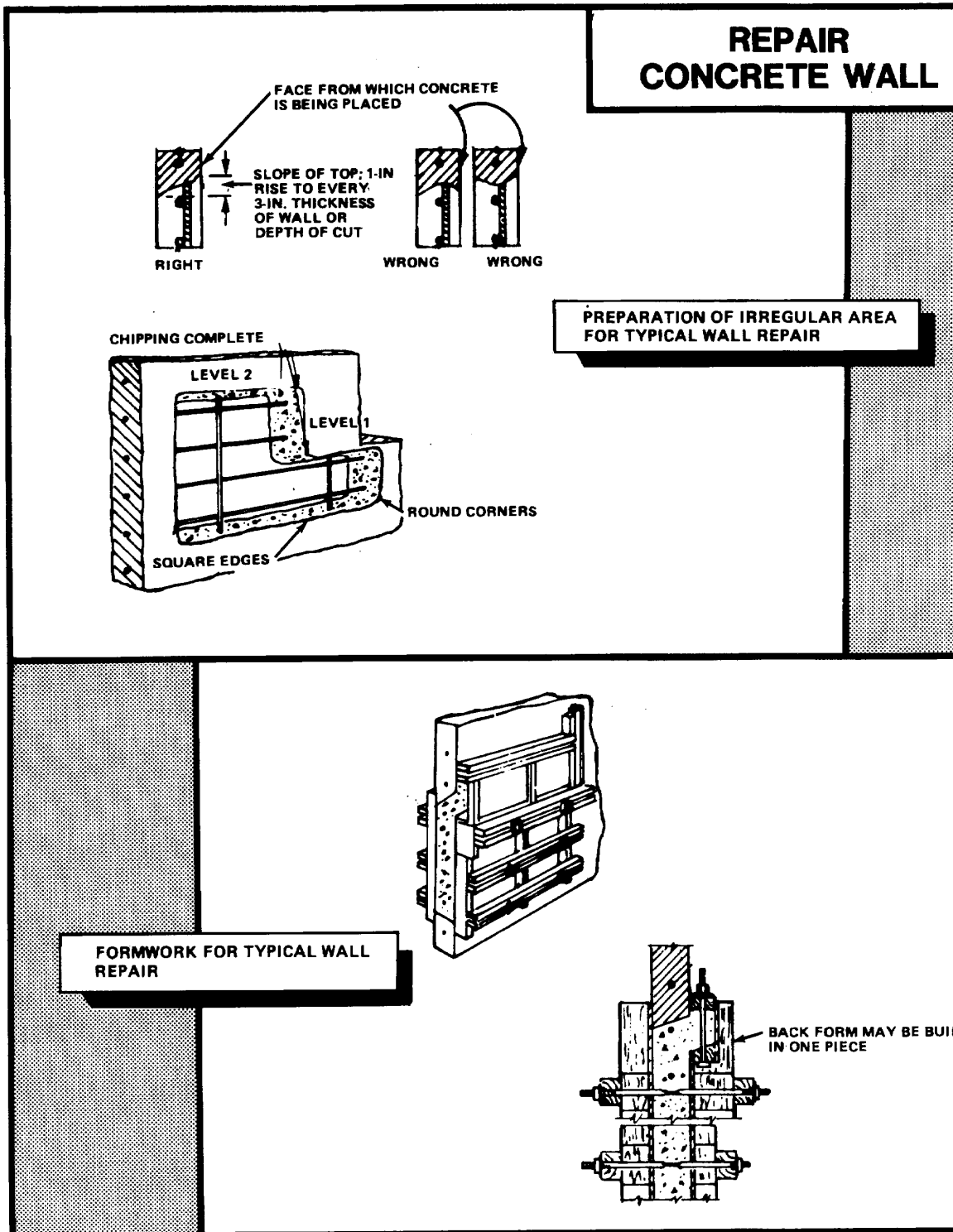

*This page intentionally left blank.*

## CHAPTER 8

### REPAIR OF STEEL STRUCTURES

8-1 **GENERAL.** Steel is used extensively in construction and repair of waterfront facilities due to availability, cost, ease of fabrication, physical and mechanical properties, and the design experience with its use. Structural steel and cast or fabricated steel are used in all areas of the waterfront. Typical applications requiring maintenance include:

- Piers, wharves, bulkheads, and quaywalls using steel H-piles or pipe piles to support or brace the structure; steel sheet piling used to retain fill; structural steel shapes used for framing.
- Fender systems incorporating steel H-piles.
- Mooring hardware such as cleats, bollards, bitts, and chocks made from cast or fabricated steel.
- Other items such as utility lines, grating, opening frames, space manhole covers, fences, bolts and nuts, handrails, and concrete reinforcement.
- Steel components of camels.

Corrosion is the major cause of deterioration of steel structures and components. The extent or severity of corrosion will vary with the exposure zone of the material; that is, whether it is in the atmospheric zone, the splash or tidal zone, or the submerged zone. Selection of the repair technique must consider each of these varied conditions and such other elements as:

- Facility mission and required life.
- Extent of damage and deterioration.
- Estimated life expectancy with repairs and without repairs.
- Projected load capacities.
- Problems associated with mobilization of equipment, personnel, and materials to accomplish repairs/maintenance.
- Tides and currents
- Economics and trade-offs.

Maintenance and repair of steel structures and components fall into five general categories: coating and wrapping, cathodic protection, concrete encasement, partial replacement, and complete replacement.

**8-2 PLANNING THE REPAIRS.** Repairing steel structures are often controlled by the availability of skilled personnel and equipment. In many cases, structural repairs, particularly of bearing piles and sheet piling, will be done by contract.

The initial planning step for establishing the repair approach must involve review of prior inspection reports to determine the scope of damage or deterioration, the rate of deterioration, and specific operational constraints placed upon the facilities because of the deterioration. Once the scope of repair requirements, including priorities, is established, how the work will be done, whether in-house or by contract, must be determined.

**8-2.1 Special Skill Requirements.** Repairing the pier decking and curbs, pile caps, fender system, and deck hardware involves having skills common to in-house shop forces. Underwater repairs require special skill levels that may not be available with in-house forces. These include general diving capability plus knowledge of:

- removing marine growth
- jetting or air lifting procedures
- underwater cutting, welding and drilling techniques
- underwater lifting procedures
- application techniques for underwater protection coatings
- wrapping materials used in underwater construction

**8-2.2 Equipment Requirements.** Repairing pier decking and curbs, pile caps, fender system and deck hardware requires equipment common to in-house shop forces. Equipment for bearing or sheet piling repairs, however, may include:

- high-pressure water blaster
- hydraulic grinders with barnacle buster attachment
- hydraulic drill with bits
- hydraulic power unit



- oxygen arc cutting and oxy-acetylene torch equipment
- protective clothing and gloves for personnel handling epoxy coatings for steel
- concrete pump with hose
- jetting pump and hose
- rigging equipment
- float stage and scaffolding
- cofferdams
- clamping template for cutting piles
- special clamping equipment
- crane

8-3        **REPAIR PROCEDURES.** Repair techniques for waterfront steel structures are summarized in Table 8-1. Selecting a technique must address both immediate repairs necessary to restore the structure to full (or other designated) usage and protective measures needed to prevent further corrosion. Selecting a means for restoring the structural capacity of the facility may be straightforward, being generally controlled by the level and rate of deterioration. Decisions on the level of protection needed to inhibit future corrosion may be more difficult. Generally, these decisions are economically driven.

Each repair decision must carefully weigh the long-term operational requirements and existing environmental factors (tides and currents) that can help accelerate corrosion before evaluating initial and life cycle costs. In many cases, combining cathodic protection and protective coating in the repair decision may be the most cost effective in the long term. Using any of the repair techniques that follow should fully adhere to the preservation treatment requirements outlined for steel structures in Chapter 3.

Damaged steel hardware such as cleats and bollards in general should be replaced in kind. Care should be taken that the engineer determine the cause of failure and that the replacement item conforms to NAVFAC Standard Details.

**Table 8-1 Repair Techniques for Steel Structures**

Repair No.	Description
<b>Bearing Piles</b>	
SR-1	Protecting Steel Piles by Coating
SR-1	Cathodic Protection for Steel Bearing Piles
SR-3	Partial Replacement of Steel Piles
SR-4	Repairing Steel Pile with Concrete Encasement
SR-5	Complete Replacement of Steel Pile
<b>Sheet Piling Walls</b>	
SR-6	Coating and Cathodic Protection for Steel Sheet Pile Wall
SR-7	Patching of Steel Sheet Pile Wall
SR-8	Reinforcing Tie-Back Systems for Steel Sheet Pile Wall
SR-9	Replacement of Existing Steel Sheet Pile Wall
SR-10	Installing a Concrete Cap or Face on a Steel Sheet Pile Wall
SR-11	Scour Protection for Steel Pile Supported Waterfront Structure

## SR-1: PROTECTING STEEL PILES BY COATING OR JACKETING

**Problem:** A new steel pile has been installed or an existing pile has experienced slight deterioration (less than 15 percent) of the cross-sectional area at some point. Protection against further corrosion is required.

**Description of Repairs:** Clean steel above water with abrasive blasting equipment and underwater with water jet cleaning equipment.

Epoxy-Polyamide Coating: See the Paragraph entitled, "Protective Coatings for Steel" (see Figure 8-1).

Fiberglass Jacket: Place jacketing around pile and secure. Pour epoxy grout inside sleeve if grout is used. Seal the top and bottom of the pile to prevent water entering inside jacket, if mortar is placed between pile and jacket (see Figure 8-1).

Concrete Jacket: During installation of steel pile, place a concrete pipe jacket around pile after it is driven. Fill the annular space between concrete jacket and pile with concrete (see Figure 8-1). The pile must be accessible from the top.

**Application:** These methods can be used to prevent further rusting. Economics will govern which method is used based on the extent of overall facility deterioration, access to pile, and availability of alternatives.

**Future Inspection Requirement:** Increased inspections may be required, particularly in areas where ice may be present, to detect signs of abrasion of the mastic or jacketing and renewed corrosion of the pile.

Figure 8-1 Protecting Steel Piles by Coating or Jacketing

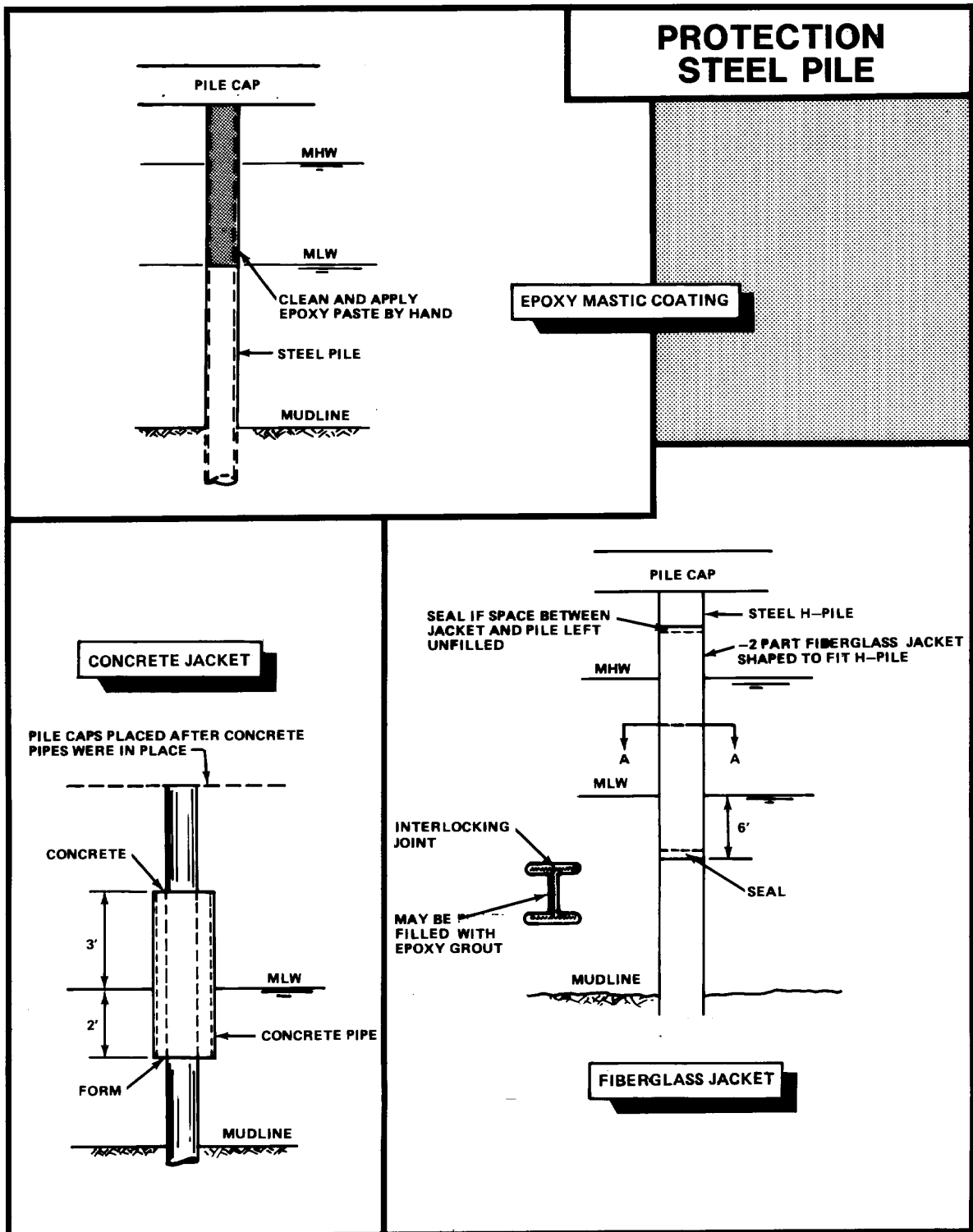

## SR-2: CATHODIC PROTECTION FOR STEEL BEARING PILES

**Problem:** New steel bearing piles have been installed or existing piles have experienced slight surface deterioration. Anticipated corrosion is high. Protection against further corrosion is required.

**Description of Repairs:** Two methods are available for providing cathodic protection for steel bearing piles:

**Sacrificial Anode System:** Secure sacrificial anodes below low water on steel by welding or bolting. Size, type, and spacing of anodes must be determined to suit structure and environment (see Figure 8-2). A good electrical connection between elements must be maintained.

**Impressed Current System:** Install the cathodic protection system as shown in Figure 8-2. Basic components include:

- Anode: Material to be consumed over a long period of time.
- Electrical potential: Power source (rectifier) to provide constant electrical potential between anode and steel pile.
- Ground between piles and power source to provide closed cell.

**Application:** Requires careful design and installation. System is not effective for mitigating corrosion above mean low water.

**Future Inspection Requirements:** The cathodic protection system must be carefully monitored and maintained. If anodes for an impressed current system are placed between bents, special inspections must be made to ensure that floating debris has not damaged or removed the individual anodes.

Figure 8-2 Cathodic Protection for Steel Bearing Piles

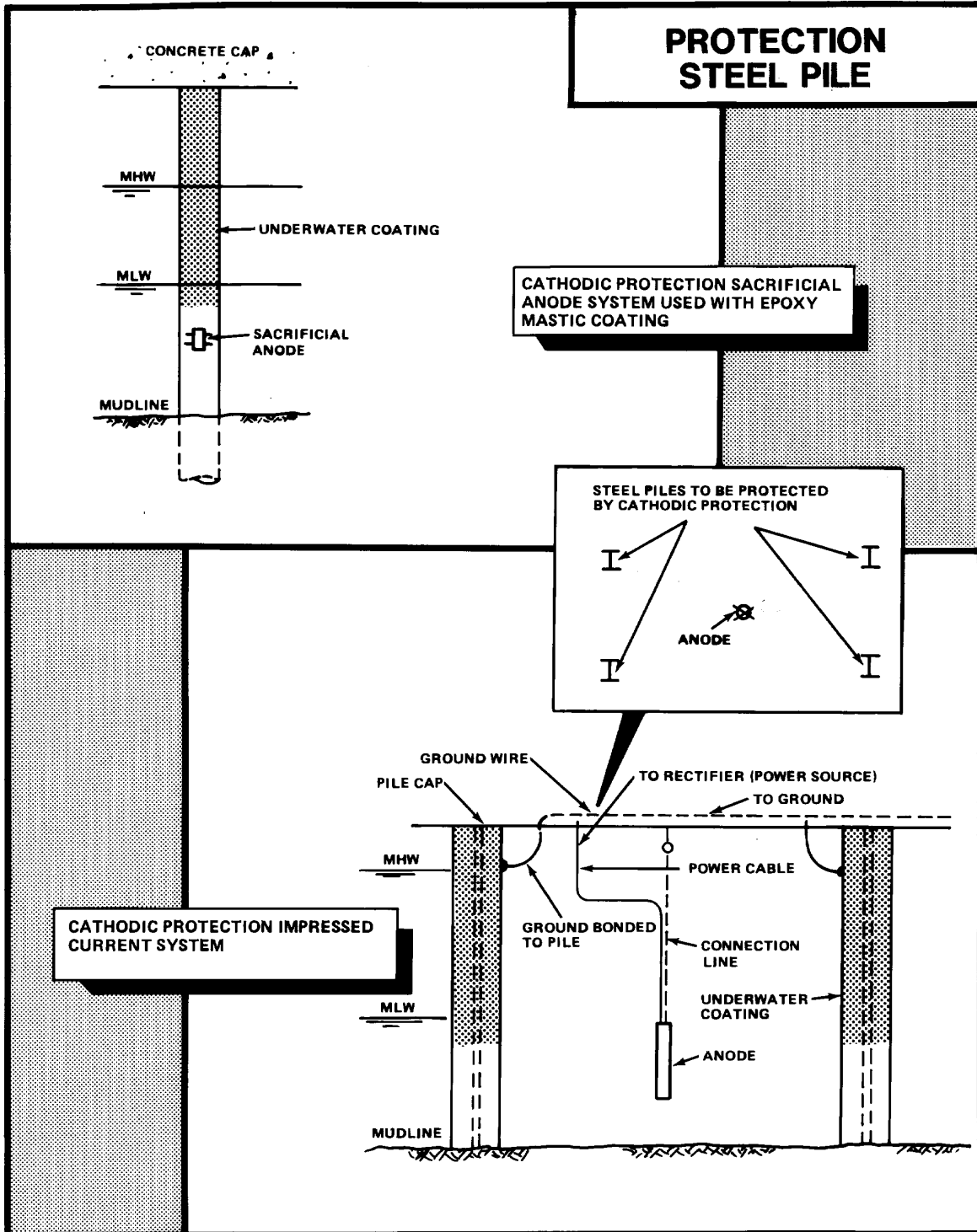

### SR-3: PARTIAL REPLACEMENT OF STEEL PILE

**Problem:** Moderate to heavy deterioration (greater than 35 percent) of the upper cross-sectional area of the H-pile has occurred.

**Description of Repairs:** Cut out the corroded section of pile; be sure that the bottom cut and top cut (if applicable) are square. Temporary supports may be needed to transfer the load from the pile being repaired to adjacent piles. Fabricate a welded assembly consisting of: a 1-inch (25 mm) steel bearing plate, two 2/5-inch (10 mm) steel side plates, and four steel angles. Place over the bottom cut. Drill and bolt the bearing assembly to the remaining lower steel pile using 1 1/4-inch (32 mm) galvanized steel bolts. Add cathodic protection to new the section.

Intermediate Replacement (see Figure 8-3): Cut a section of new H-pile to fit the missing length of pile and weld a 1-inch (25 mm) steel bottom bearing plate to the new section. Place the intermediate section into position and bolt the bearing plates together. Weld the upper joint and four 5/8-inch (16 mm) steel splice plates to both old upper and new H-pile sections.

Total Upper Section Replacement (see Figure 8-3): Cut a new section similar to that required for intermediate replacement, except cut to fit under the concrete cap using a 1-inch (25 mm) steel bearing plate bolted to the cap. This arrangement is necessary when the steel has corroded extensively at the concrete-steel interface. All new metal should be cleaned and coated before installation. Welded joints should be cleaned and coated after welding. All welded joints should be watertight.

**Application:** This method restores the structural strength lost in the deteriorated upper section. Corrosion can again occur once the coating fails. Economics will govern approach.

**Future Inspection Requirement:** Same as for new steel pile sections.

Figure 8-3 Repair by Partially Replacing the Steel Pile

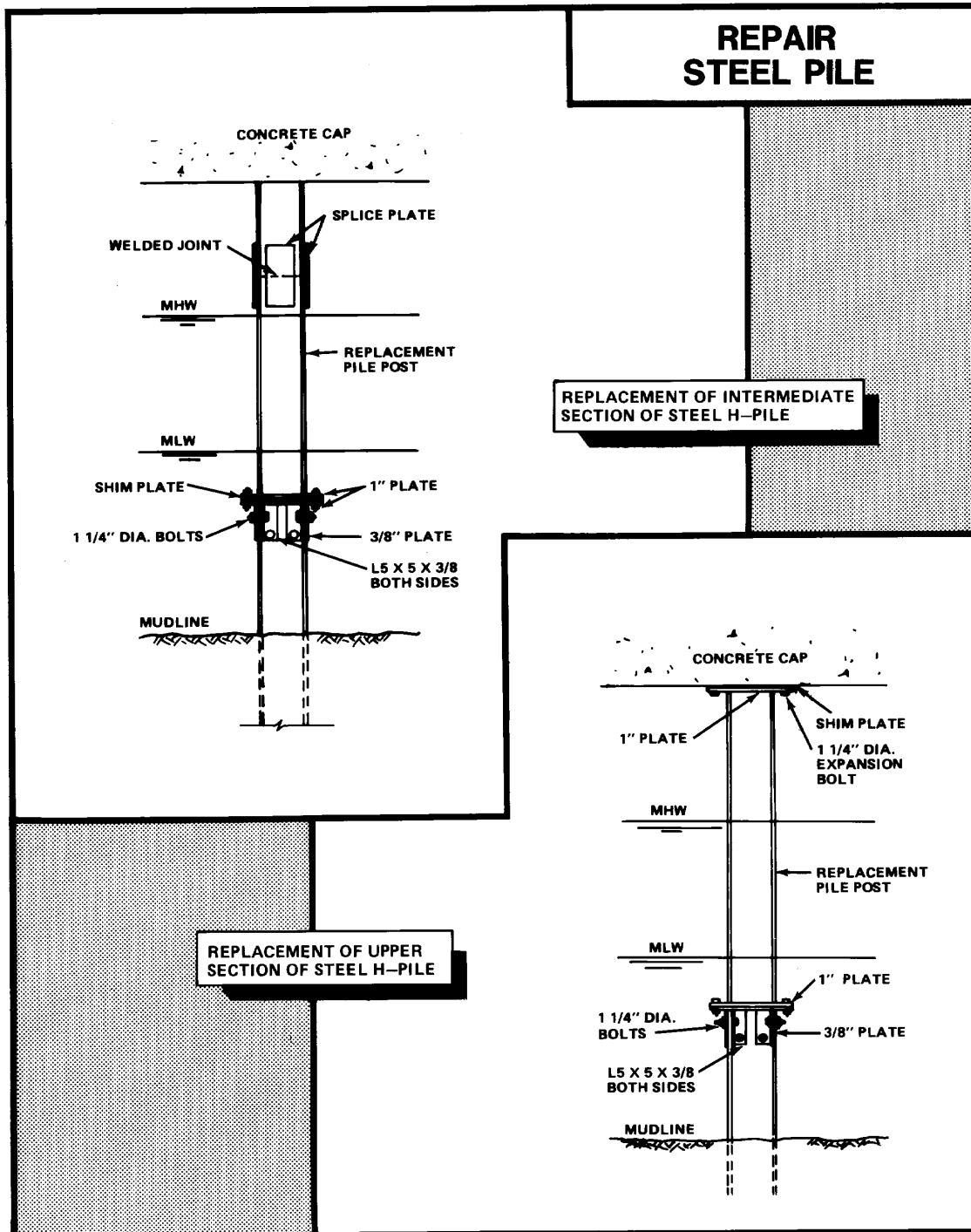



#### SR-4: REPAIRING STEEL PILE WITH CONCRETE ENCASEMENT

**Problem:** Slight to moderate deterioration (less than 35 percent) of the cross-sectional area has occurred; or protection against corrosion and abrasion is required.

**Description of Repairs:** Clean the steel pile of all marine growth and loose rust using a high-pressure water blaster. Two methods may be used to provide the concrete encasement: flexible and rigid form. In addition, steel angles may be used with the rigid form, to regain some of the reinforcement in the steel pile where greater levels of deterioration have occurred (see Figure 8-4). After the piles have been thoroughly cleaned, place a 6- by 6-inch (150- by 150-mm) reinforcing mesh around the pile, using spacers to maintain clearance between the pile, reinforcing, and fabric form. The fabric form should be placed around the pile.

For the flexible form, the zipper should be closed, and the form secured to the pile at the top and bottom with mechanical fasteners (see Figure 8-4).

For the fiberboard form, the straps are installed and secured every 12-inch (300-mm). Maintain a 1 ½-inch (38-mm) space between the pile and reinforcing and between the reinforcing and form (see Figure 8-4).

The annular space between the pile and the form is then filled to overflowing with concrete grout using a tube or hose extending down to the lowest point of the form. The form is left in place and the base is backfilled to above the concrete.

**Application:** This method can be used as a repair or as a protection technique to prevent further rusting or abrasion. The method will not restore bearing capacity lost by the deterioration of the steel cross section. Partial restoration of compressive strength may be gained by the using steel angles with the concrete encasement. This is not a generally accepted practice, however, so care must be used to ensure that the connections are made to sound metal. Many times, posting the existing pile with a new H-pile section may be more cost effective. Economics would normally govern the decision.

**Future Inspection Requirement:** Increased inspections may be required to detect signs of potential failure of the repair.

Figure 8-4 Repair Steel Pile Using Concrete Encasement

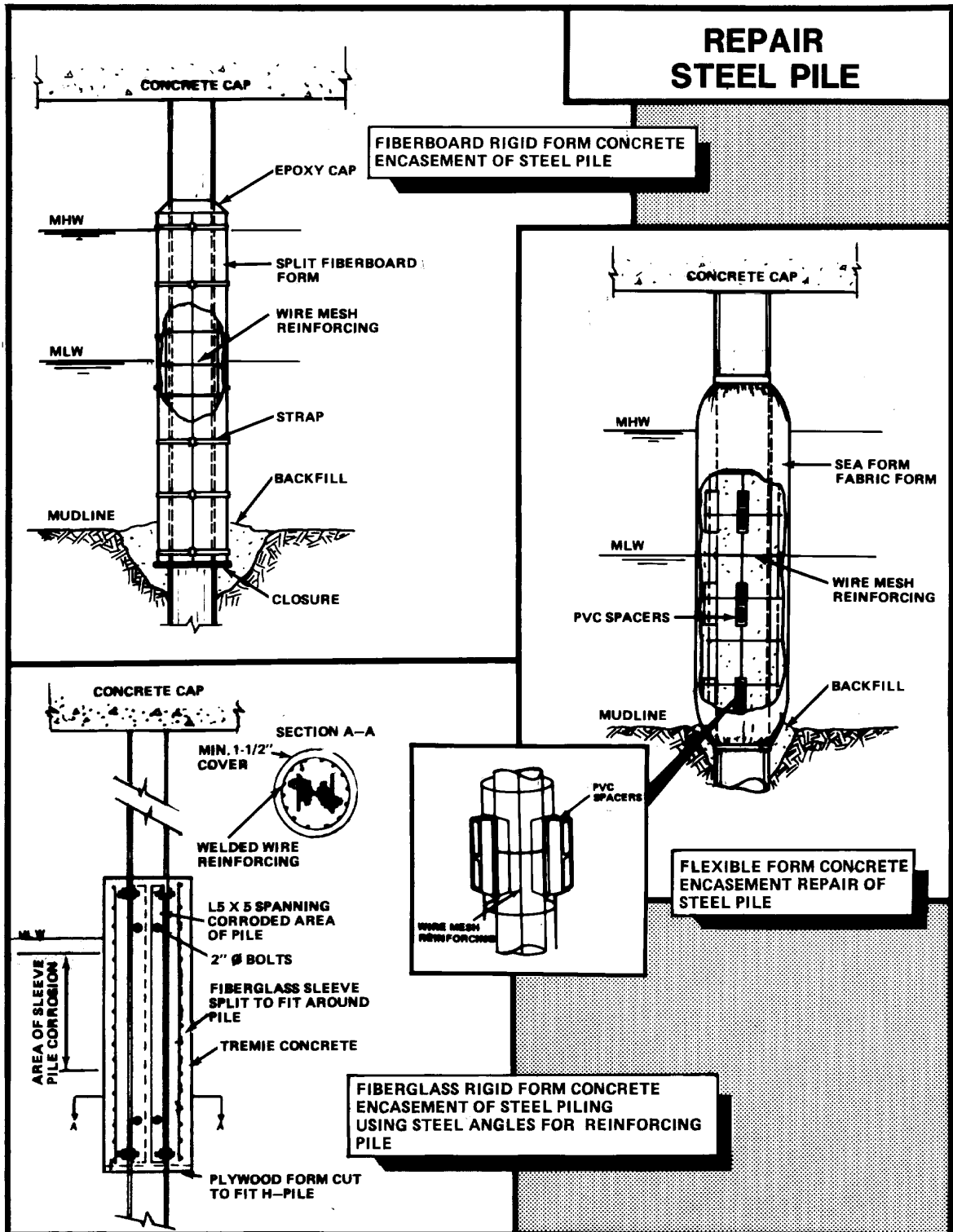

### SR-5: COMPLETE REPLACEMENT OF STEEL PILE

**Problem:** Moderate to heavy deterioration (greater than 35 percent) of the cross sectional area, or damage has occurred to a steel H-pile.

**Description of Repairs:**

**Using Existing Pile Cap.** Cut an opening in the concrete deck adjacent to the damaged pile. Drive the new steel pile and cut to fit under the existing pile cap. Pull the pile laterally into place (see Figure 8-5). Shim between the pile and pile cap and secure the pile to the pile cap using 1 ¼-inch (32-mm) expansion bolts.

**With New Pile Cap.** Cut an opening in the concrete deck between existing pile locations. Drive the new steel pile through the hole cut in the deck and cut off below the top of the concrete deck (see Figure 8-5). Weld horizontal reinforcing bars to the top of the steel replacement pile or provide suitable reinforcing steel transitions with concrete piles, to ensure load transfer. Form the pile capital under the deck and around the new pile, and fill the form and deck space with concrete. Ensure that new and existing piles are electrically isolated otherwise accelerated corrosion may be experienced with the new piles.

**Application:** This method restores the structural strength lost with the deteriorated pile. The same corrosion can occur, however, with the new pile. Concrete encasement or cathodic protection can be used to extend life expectancy. Economics will govern approach.

**Future Inspection Requirement:** Same as for new steel or concrete pile sections.

Figure 8-5 Replacing Damaged or Deteriorated Steel Piles

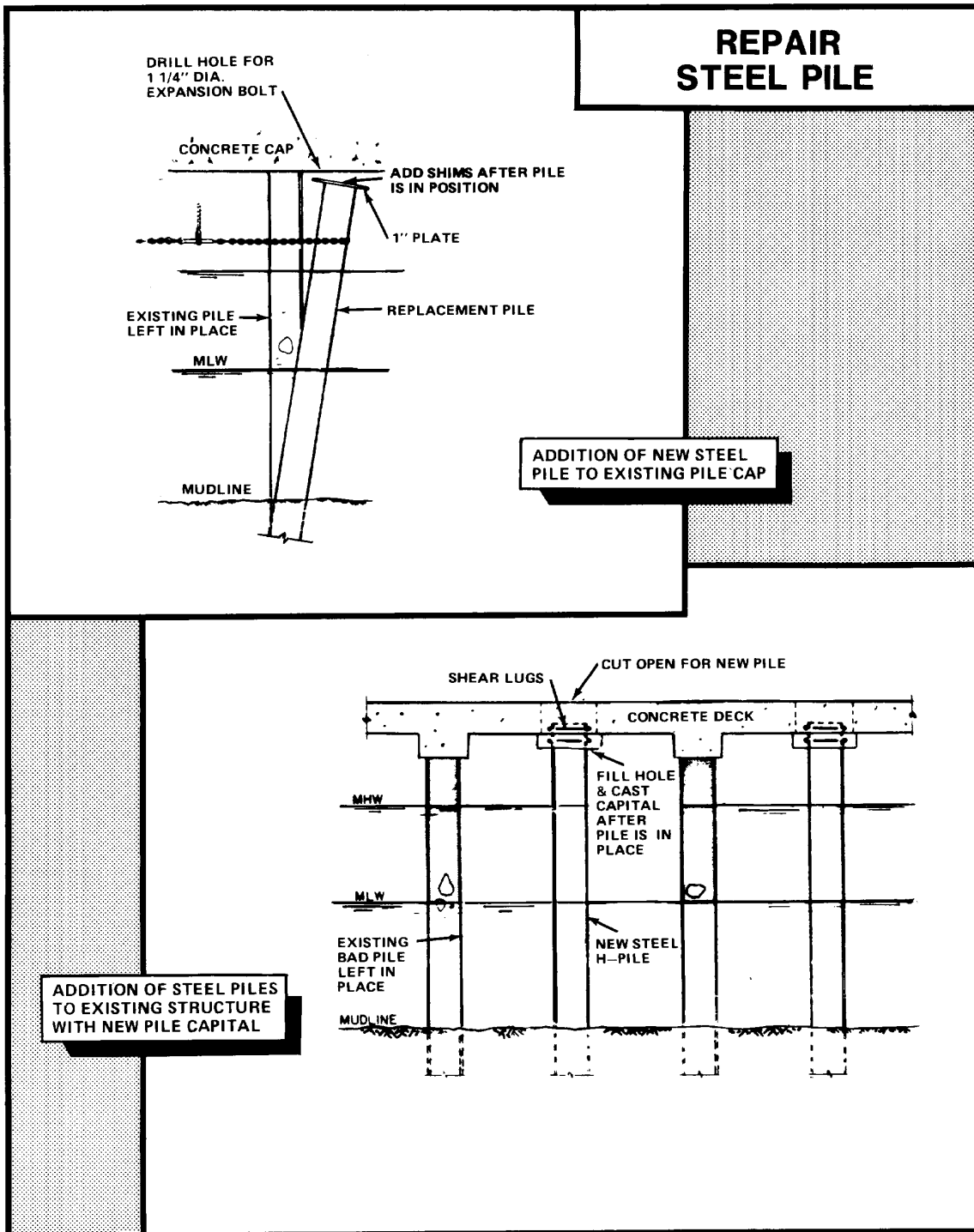

**SR-6: COATING/CATHODIC PROTECTION OF STEEL SHEET PILE WALL**

**Problem:** Sheet pile wall has surface deterioration. Protection against further corrosion is required.

**Description of Repairs:** Two procedures provide corrosion protection for steel sheet piling:

Coatings. See the Paragraph entitled, "Protective Coatings for Steel" (Submerged and Splash Zone). See Figure 8-6.

Cathodic Protection: For sacrificial anode system, weld or bolt anodes below low water on the steel. Determine size, type, and spacing of anodes to suit structure and environment. A low resistance electrical connection between adjacent piling must be made (see Figure 8-6). For impressed current systems, place anodes off the face of the sheet pile wall.

**Future Inspection Requirement:** Increased inspection may be required, particularly in areas where ice may be present, in order to detect signs of abrasion of the mastic or removal of the anodes and renewed corrosion of the sheet piling.

Figure 8-6 Coating/Cathodic Protection of Steel Sheet Pile Wall

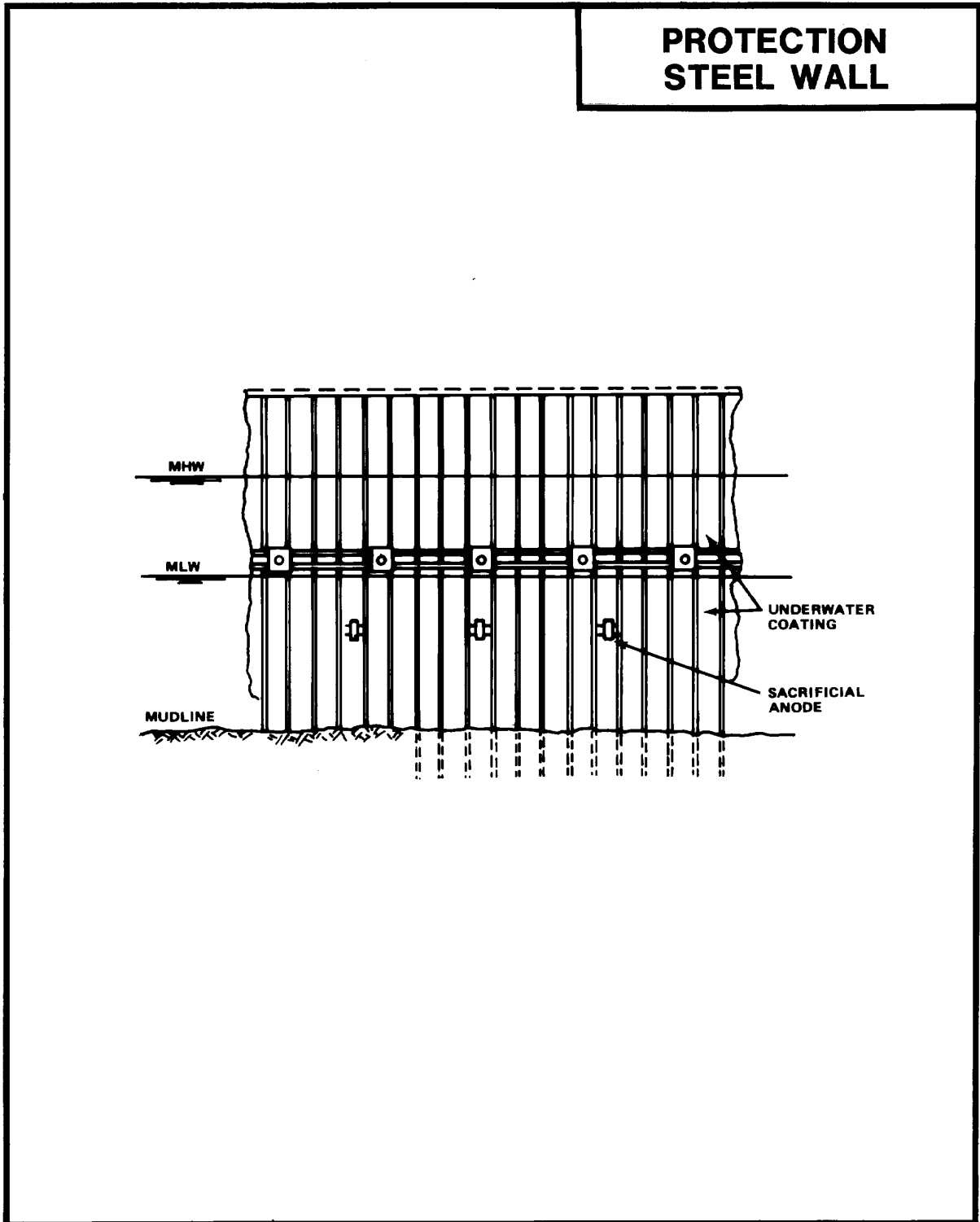

### SR-7: PATCHING STEEL SHEET PILE WALL

**Problem:** Steel sheet pile wall has small to medium holes. General condition of sheet piling is otherwise sound with minimum signs of corrosion.

**Description of Repairs:** Clean around area to be patched. For larger holes using steel plate patches, clean sheet piling from 18-inch (460-mm) below holes to above mean low water.

**Epoxy Patch:** Weld wire mesh or bolt fabric mesh over holes and cover with epoxy-polyamide putty smeared on by hand (see Figure 8-7). Good for a limited number of small holes.

**Steel Plate Patch:** Determine size of patch plate needed. Cut plate to size and bend plate to fit over sheet pile interlocks. Weld plate in place at top, above low water. Cut holes for Tee bolts in sheet piling behind holes in plate; place and tighten Tee bolts (see Figure 8-7). Alternative is to weld plate all around, which is more appropriate for larger holes or several small holes.

**Patch and Pressure Grouting:** Where several small holes make pure patching cost expensive, a combination of patching and grouting may be a better solution. In this approach, cover the larger holes with epoxy or steel plate patches, then pressure grout the area behind the wall (see Figure 8-7).

**Application:** This approach will not prevent further corrosion and its success depends on the surrounding areas of sheet piling being relatively sound and free from rust. Continued deterioration of a weak structure, particularly near tiebacks, could lead to rapid failure and poor use of repair funds. Economics should govern final selection of the repair method.

**Future Inspection Requirement:** Increased inspection will be required at the patch areas to ensure that welds and bolted connections continue to hold.

Figure 8-7 Repairs to Steel Sheet Pile Walls Using Different Patching Methods

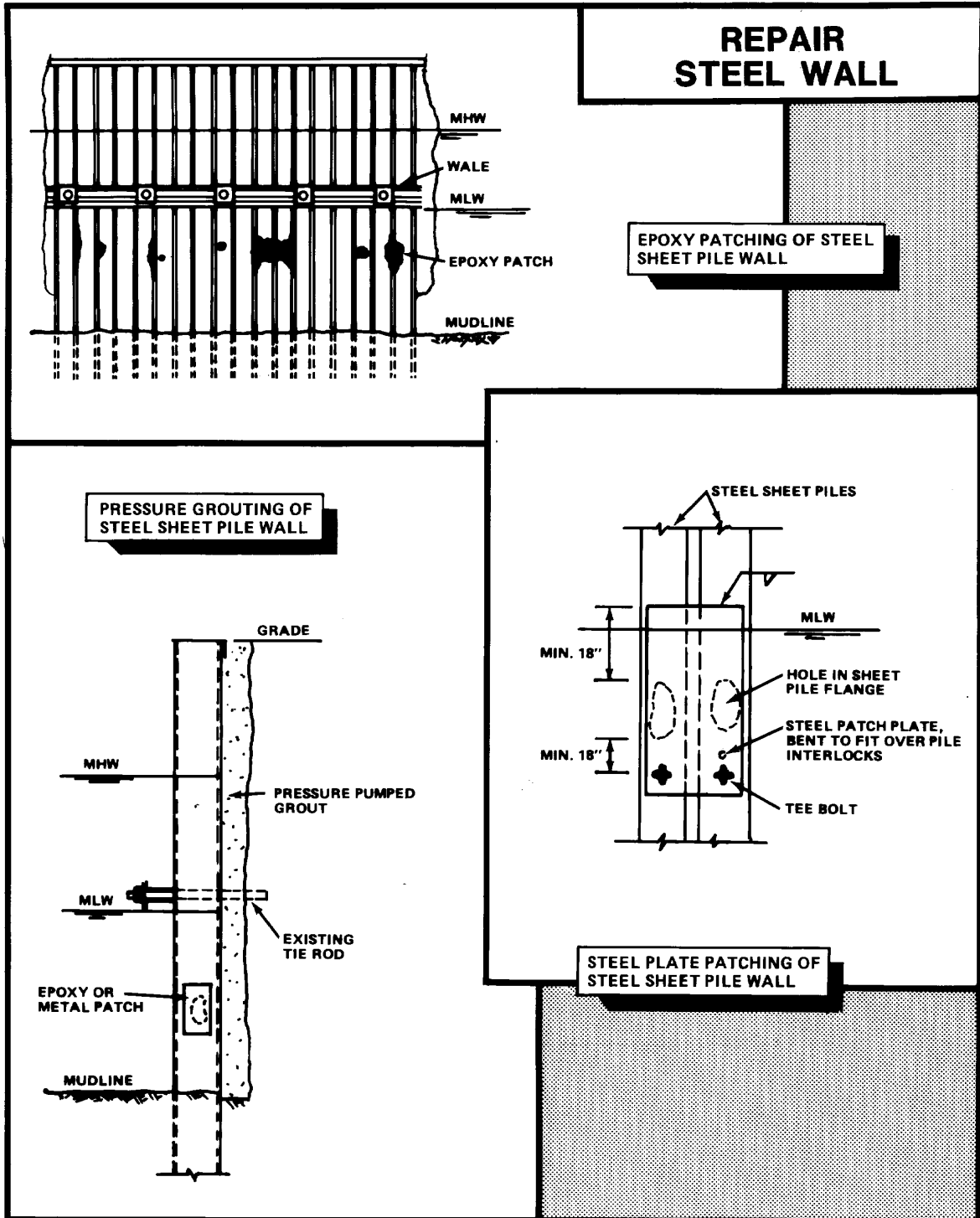



## **SR-8: REINFORCING TIE-BACK SYSTEMS FOR STEEL SHEET PILE WALL**

**Problem:** Light to moderate movement of the top of the steel sheet pile wall has occurred due to tieback failure or excessive loading behind the wall. The area behind the wall is accessible to perform repairs.

**Description of Repairs:** Install a new wale slightly above the existing wale. Locate the new deadman anchors based on engineering calculations. Trench for the tie rods between the wall and the deadman anchors. Place the tie rods through the wale and sheet piles and secure in place to the deadman anchors (see Figure 8-8). Be sure that enough clearance is allowed through the sheet piles to electrically isolate the tie rods from the piling.

Install zinc or magnesium packaged anodes to prevent future corrosion of the rods.

Replacing an existing tieback system may involve the replacing any or all of the existing components, depending on the amount of deterioration that has taken place.

Sheet pile wall movement can also be arrested by changing the soil loading acting on the wall. For example, stone riprap dumped against the exterior toe of the wall will add resistance to the movement of the toe. Alternatively, or in addition, backfill can be removed from behind the wall and replaced with lightweight granular fill. This type of fill is free draining, which reduces the hydrostatic pressure behind the wall and allows the water level on both sides to balance.

**Application:** Reinforcing or replacing the tieback system may be restricted to correcting slight to moderate wall deflection. Excessive deflection may require wall replacement or major restoration.

**Future Inspection Requirement:** Carefully inspect the wall for further signs of continued deflection or steel member failure.

Figure 8-8 Installing or Replacing Tieback Systems for Steel Sheet Pile Wall

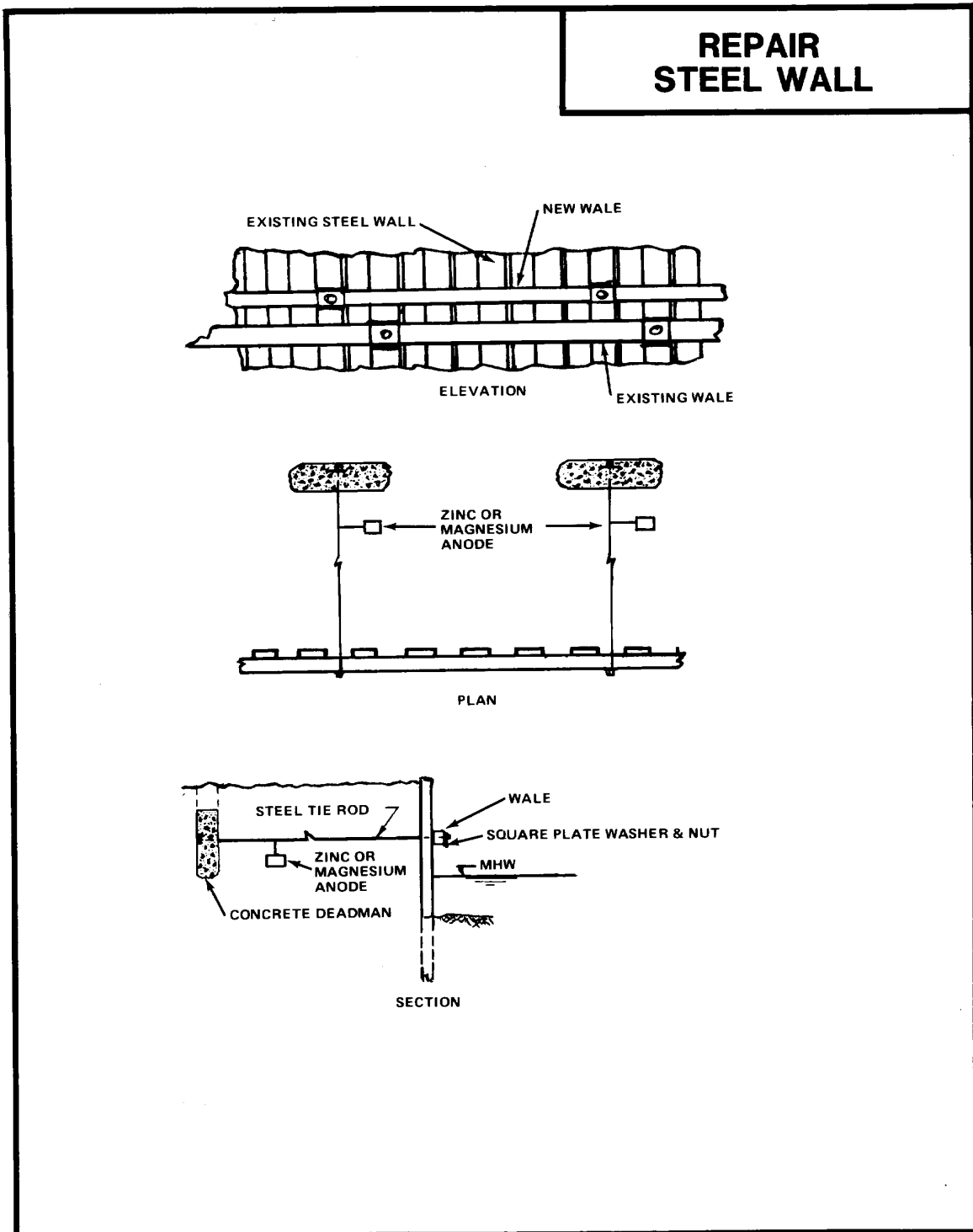

## SR-9: REPLACEMENT OF EXISTING STEEL SHEET PILE WALL

**Problem:** Serious deterioration of the steel sheet pile structure has occurred; patches cannot be used for repairs.

**Description of Repairs:** Two methods are available for replacing deteriorated steel sheet piling:

**Timber Sheet Piling:** Remove decking (if required) behind existing steel sheet pile wall to provide enough space to excavate and drive timber piling. Excavate to expose tie rods (usually these are above mean low water). Place new timber wales to act as template for driving timber sheeting. Drive timber sheeting (see Figure 8-9). Backfill may not be possible between steel sheeting and timber sheeting below wales. Replace decking (as applicable).

**Steel Sheet Piling:** Drive new steel sheet piling in front of existing sheet piling. Drill hole for tie rod and pipe casing through both walls into stiff clay, out of active zone behind old wall. Pressure grout inside casing forming bulb in clay at end of casing (see Figure 8-9). Fill space between old and new sheet piling with concrete. If stiff clay is not available, deadmen may need to be added to secure the tie rods. Ensure electrical isolation is maintained between the existing and new sheet piling, especially through tie rods.

**Application:** Either solution should stop the loss of backfill through the existing steel sheetpiling wall.

The timber sheet piling should be less expensive than the new steel sheetpiling wall. However, the timber piling will require access behind the existing wall, and continued corrosion of the existing steel sheet piling can be expected.

The new steel sheet piling can provide a new wall with equal or greater strength; and construction can be done without excavating behind the existing wall. This approach does, however, require grouted tie rods be secured in existing soil. If stiff clay or other suitable soil is not available, this method may not be appropriate unless deadmen are added.

**Future Inspection Requirement:** Normal inspection requirements should suffice for the new steel sheet pile wall. If the timber piling approach is used, more extensive annual inspections may be required to watch for signs of timber piling deterioration and failure behind the existing wall.

Figure 8-9 Replacing Existing Steel Sheet Pile Wall With New Steel Sheetpiling Or Timber Sheet Pile Wall

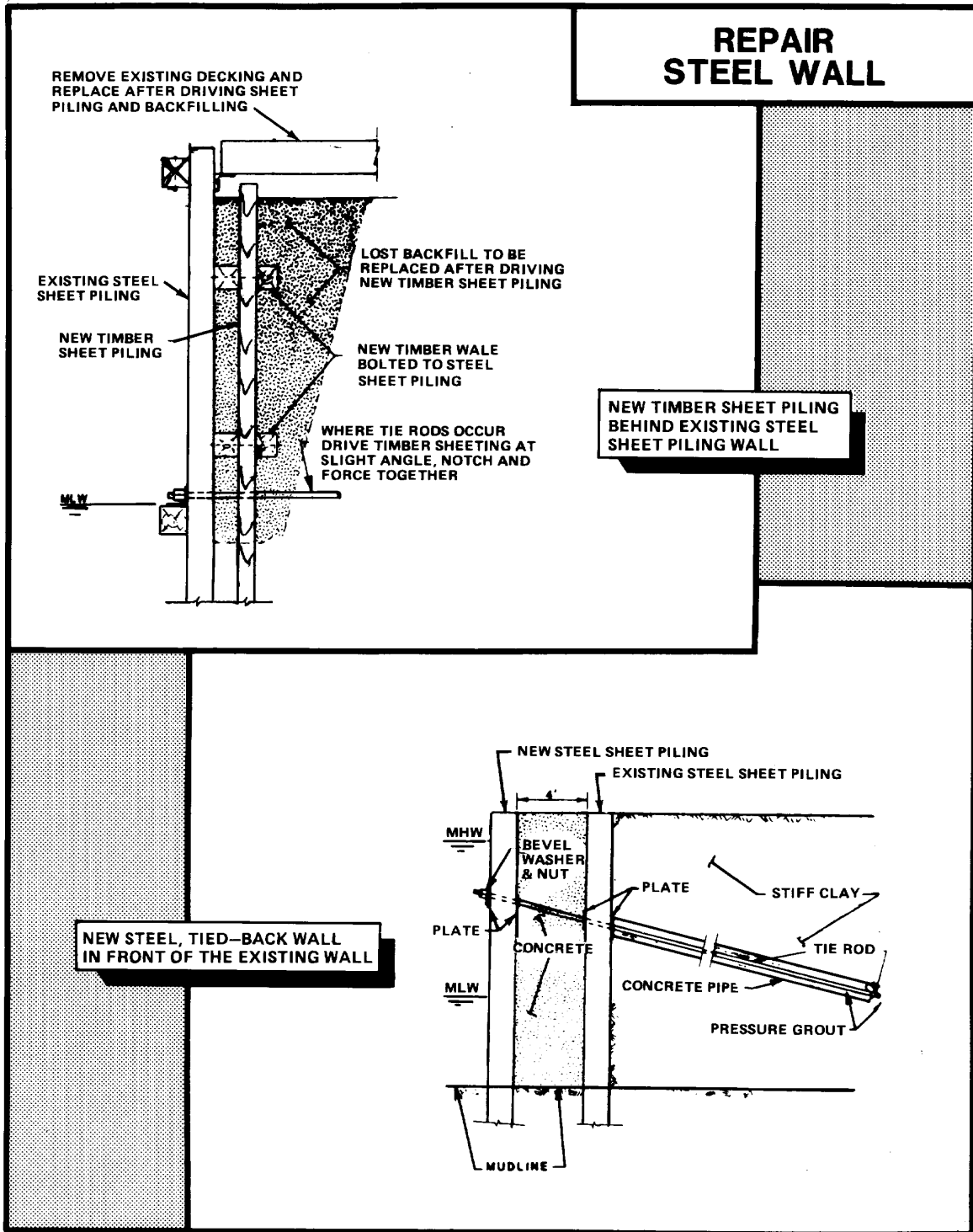

## SR-10: INSTALLING A CONCRETE CAP/FACE ON A STEEL SHEET PILE WALL

**Problem:** Large-scale deterioration of the steel sheet pile structure has occurred; patches can not be used for repairs.

**Description of Repairs:** Excavate the soil from behind the wall to a level required for the new concrete cap or attachment of form ties for a concrete face. Remove all marine growth and deteriorated steel and clean surfaces. Two methods are available for installing a concrete cap/face:

**For Concrete Cap:** Build forms, place reinforcing, and pour concrete at mean low water. After curing, remove forms and backfill behind wall (see Figure 8-10).

**For Concrete Face:** Place and fasten blocking and low wale against existing sheet piling. Drive the timber sheet pile wall about 12 inches (300 mm) in front of existing sheet piling using wale as a guide. Attach outside wales to timber sheeting and place concrete by pumping or tremie. Leave timber sheet piling in place or remove as desired (see Figure 8-10).

For partial concrete facing of steel sheet pile wall, techniques exist to repair a deteriorated wall from the exterior side without requiring excavating. One method uses timber formwork (see Figure 8-10), welding steel studs to the steel sheet pile at locations where the metal is sound. The shear lugs help to hold the concrete in place. A temporary steel frame, which supports the timber formwork, is suspended from the top and welded to the exterior of the wall above the waterline. Blocking is used to maintain a 12-inch (300-mm) minimum space, and reinforcing is placed in the center of the space. Concrete is placed by pumping or tremie method. The form work can be removed within a few days.

**Application:** Used to restore structural strength at the top of the wall (cap) or prevent further loss of soil through holes in the sheet piling (face). Does not restore bending moment capacity in wall. Provides protection against further deterioration.

**Future Inspection Requirements:** Annually inspect the sheet piling areas immediately under the pile cap to ensure that further corrosive damage is not being weakening the support for the concrete cap. Follow similar procedures for partial concrete faces. For complete concrete facing, follow normal inspection procedures.

Figure 8-10 Installing a Concrete Cap and/or Face on a Steel Sheetpiling Wall

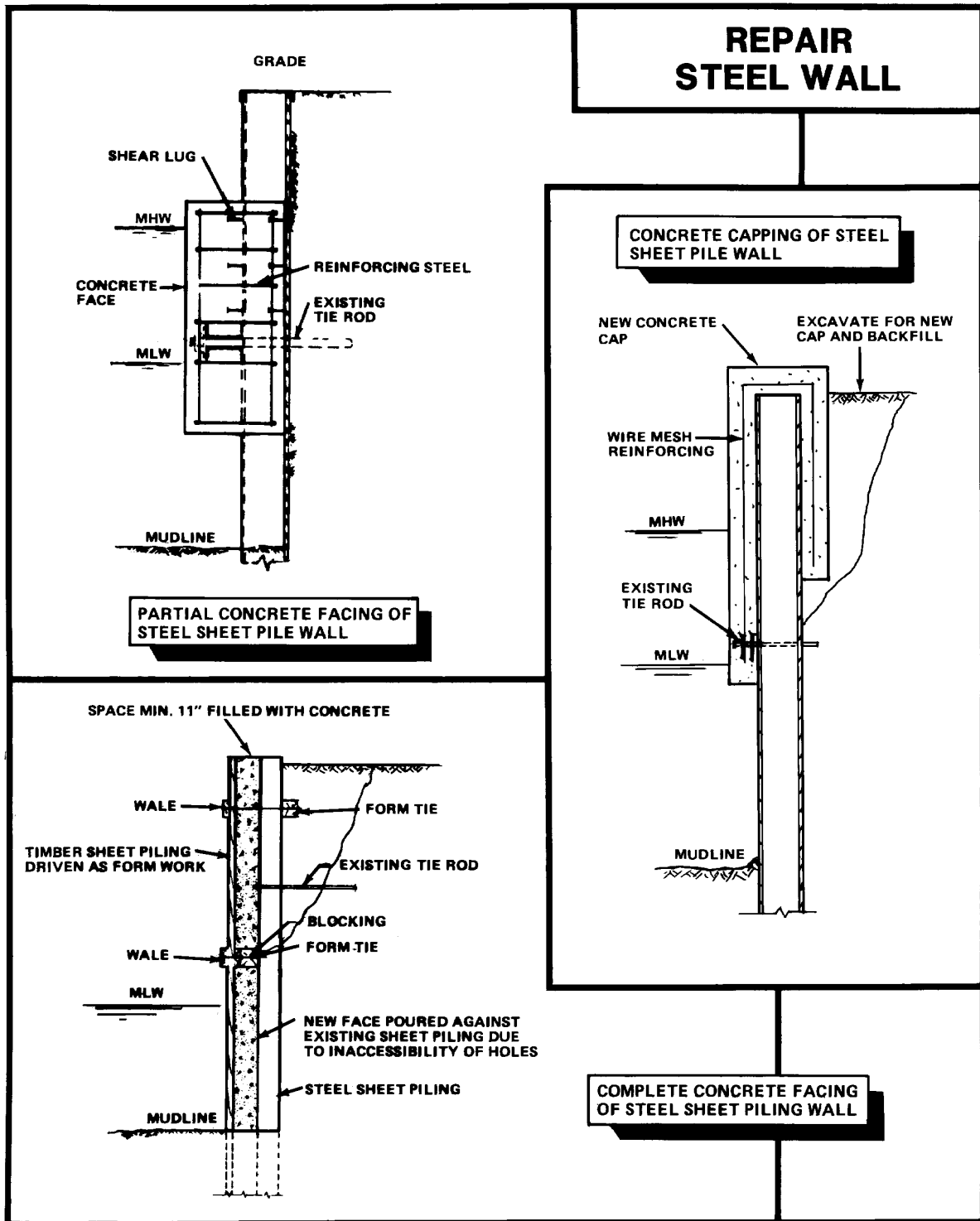

## SR-11: SCOUR PROTECTION FOR STEEL PILE SUPPORTED WATERFRONT STRUCTURE

**Problem:** Serious erosion of seabed material has occurred around a marine structure as a result of wave action and/or strong current.

**Description of Repairs:** Two methods are available for scour protection:

**Riprap Placement:** Replace the lost foundation material by dumping stones randomly into place. If stone riprap is not available, use bags of synthetic fiber woven water-permeable material filled with concrete. On sandy seabeds, a filter fabric may be required under the riprap or bags to prevent scour through the individual units (see Figure 8-11). The materials most commonly used are commercially available synthetic fiber, non-woven fabrics weighing between 8 and 12 ounces per square yard (269 and 405 grams per square meter) or woven fabrics weighing between 5 and 7 ounces per square yard (169 and 236 grams per square meter.)

**Steel Sheet Piles:** Drive steel sheet piling around structure to protect soil around the bearing piles (see Figure 8-11). The decision to replace the lost foundation material under the structure should be based on the strength of the exposed piles.

**Application:** A careful evaluation should be performed to determine if: (1) any settlement of the structure has occurred due to the scour, or (2) suitable bearing capacity exists within the remaining structural foundation to support the loading. Selecting either scour protection technique should ensure that suitable structural integrity exists before beginning the repairs.

**Future Inspection Requirement:** Normal inspection requirements will generally suffice. If riprap is used, annual underwater inspection will be required to ensure that material is not lost.

Figure 8-11 Scour Protection for Steel Pile Supported Waterfront Structure

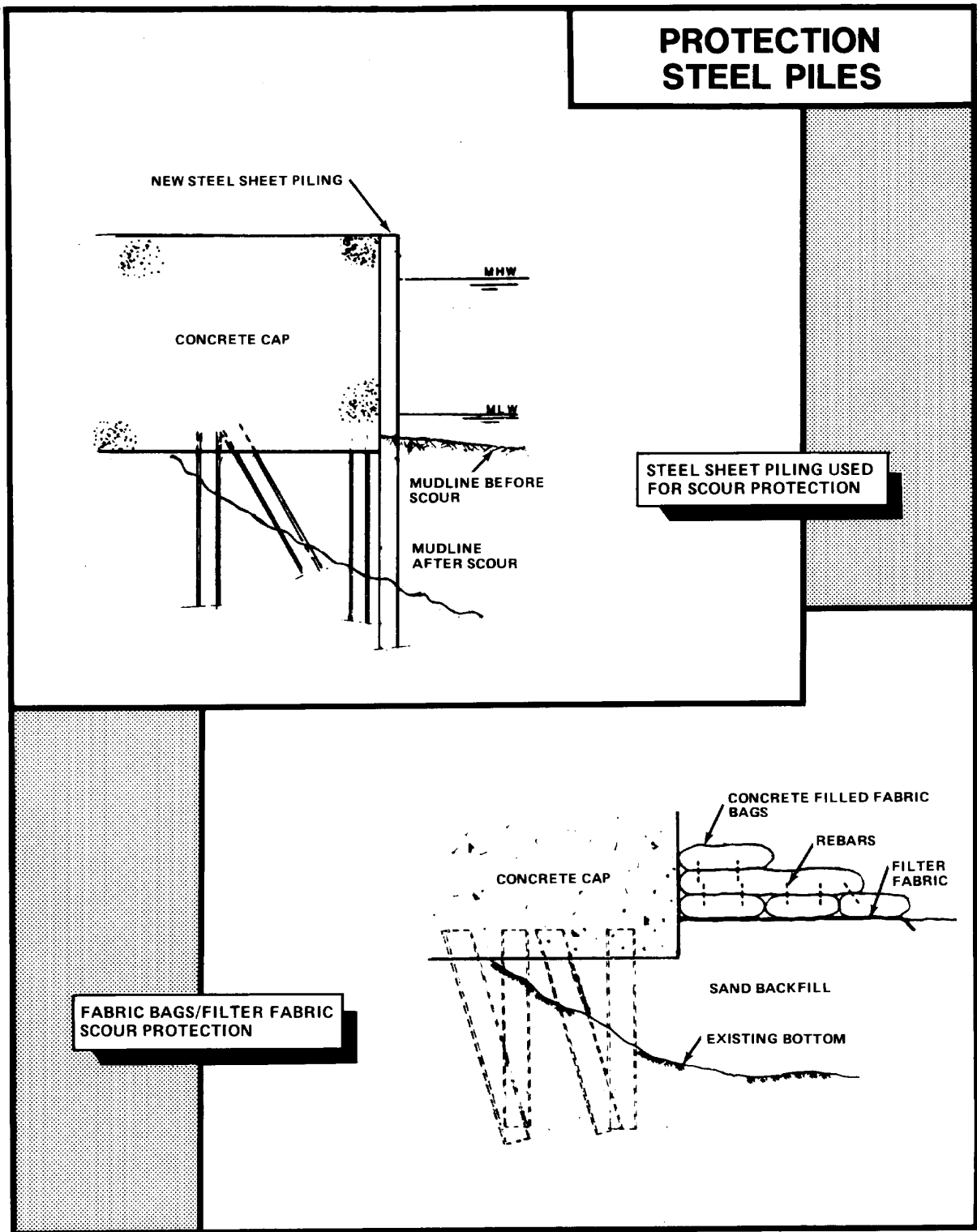



## CHAPTER 9

### REPAIR OF SYNTHETIC MATERIALS

9-1      **GENERAL.** Synthetic materials used on waterfront structures include:

- Structural components such as railings and stanchions, resilient fenders, camels, chocks, wales, piles, light standards, gratings, and piping.
- Coatings, wraps, and jackets for piles and piping.
- Buoyancy materials used in buoys, floats and foam-filled and pneumatic fenders

Deterioration of synthetic materials results from physical damage, exposure to the environment, aging, or a combination of these factors. Physical damage is the most common type of deterioration for most waterfront synthetic components. Exposure results in plastics cracking, separating or becoming brittle; foams crumble with age and lose resilience; and elastomers stretch and deteriorate from the effects of sun and exposure.

9-2      **INSPECTION OF SYNTHETIC MATERIALS.** All synthetic materials should be inspected periodically to ensure that they are clean and in good working order. If any component is damaged then it should be repaired or replaced as necessary. Repairs to synthetic materials and components will normally be controlled by the position of the components (or material) within the waterfront structure. Components, such as: railings, stanchions, resilient rubber fenders, camels, wales, chocks, light standards, gratings, and piping, will normally be replaced and may be done by shop personnel. In general, small surface damage such as burns, scratches, chips, or small cracks can be repaired, but if the damage is structural then replacement is the recommended course of action. (Table 9-1.)

**Table 9-1 Repair Techniques for Synthetic Materials**

Repair No.	Description
Small Surface Damage	
PR-1	Repair of Fiberglass, Guard Rail
Repair by Replacement	
PR-2	Repair Dry Dock Caisson Seal (See Figure 9-1)

If damage to fiber-reinforced plastic (FRP) products, either fiberglass or carbon fiber, is detected then the manufacturer should be contacted to help determine if the product can be repaired or if it needs to be replaced. Repairing these products requires specialized expertise and will require contracting services.

Repairing coatings or jackets on piling involve skilled personnel and specialized equipment; repairs may have to be done by contract. Specialized skills and equipment for applying coatings, jackets, and patches on piling are covered in Chapters 6, 7 and 8.

Special instructions and equipment requirements for repairing foam-filled fenders are covered in NAVAFAAC MO-104.1, *Maintenance of Fender Systems and Camels*.

### **PR-1: Repair of Fiberglass Guard Rail**

**Problem:** Fiberglass guard rail is chipped and is a safety hazard.

**Procedure:** Sand and clean the damaged area and ensure it is dry. Apply epoxy or a catalyzed resin to the damaged area with a putty knife or spatula. Cover the repair with cellophane and secure it. Allow the repair to cure; then remove the cellophane and sand the area smooth.

**Application:** This procedure can be routinely used for any fiberglass component. Similar procedures can be used for other synthetic components.

**Future Inspections:** Basically the same as for other deck components.

## PR-2: Repair of Drydock Caisson Seal by Replacement

**Problem:** Caisson wood or “rubber” seal is deteriorated or damaged and leaks.

**Procedure:** Move the caisson into the drydock and secure. Remove the existing wood or synthetic “rubber” seal assembly (see Figures 9-1 and 9-2.) Unless the old seal is “rubber” and the existing studs are still serviceable and in the correct configuration, remove the old mounting studs. Clean any wood or “rubber” remnants or any other obstruction on the caisson seal mounting surface. Repair surface flaws and irregularities in the caisson seal substructure to within an allowable tolerance as follows.

- Caisson seal mounting surface roughness profile should not deviate from the nominal profile by more than 98 mils (2.5 mm).
- Caisson seal mounting surface waviness profile should not deviate from its nominal profile by more than 12 mils (0.3 mm) over a waviness spacing of 12 inches (30 cm).
- Caisson seal mounting surface should be parallel to within at least 393 mils (10 mm) over the length of a span section (9 feet (2.75 meters)).

Install new mounting studs onto the caisson seal sub-structure if required. The stud material should be a MONEL alloy with the weld filler material and weld process conforming to the correct specifications for welding MONEL to carbon steel. A wood template duplicating the seal configuration hole pattern must be made for each type of seal configuration. These templates are used to properly position the new studs. Starting with the corner section, position and align the wood templates around the caisson. Mark the stud locations on the caisson using a center punch.

Mount a new isoprene “rubber” seal onto the caisson seal sub-structure. Use MONEL washers and nuts to mount the seal assemblies. Use the following procedure starting with the corner section. Be careful not to damage the assembly.

- Position the lifting fixture at the top end of the seal and lower the fixture retaining bar over the seal.
- Lift the seal out of the crate and position the bottom end of the seal over the corresponding mounting studs. The bottom of the seal should make contact with the caisson first.
- Apply a coating of rubber adhesive to mitered joints before mating.
- Install at least two nuts and washers onto the studs at the bottom to

hold the seal in place while the lifting fixture is removed.

- After the lifting fixture is removed, push the top of the seal against the caisson and install all remaining nuts and washers.
- Move the seal into position so that the mating surface at the mitered joint is aligned with the previously installed seal assembly. There should not be a gap or misalignment.
- Once the seal is in position, tighten all mounting nuts one and a half turns beyond the point where initial contact is made between the seal, caisson, nut, and washer.

**Application:** Caisson wood seals should be replaced as required by new “rubber” isoprene seals. Greenheart wood is NOT immune to marine borer attack; DO NOT USE in saltwater or brackish water.

**Future Inspections:** Caisson seals should be visually inspected before each use and if any leakage occurs.

Figure 9-1 Typical Caisson Wood Seal Assembly

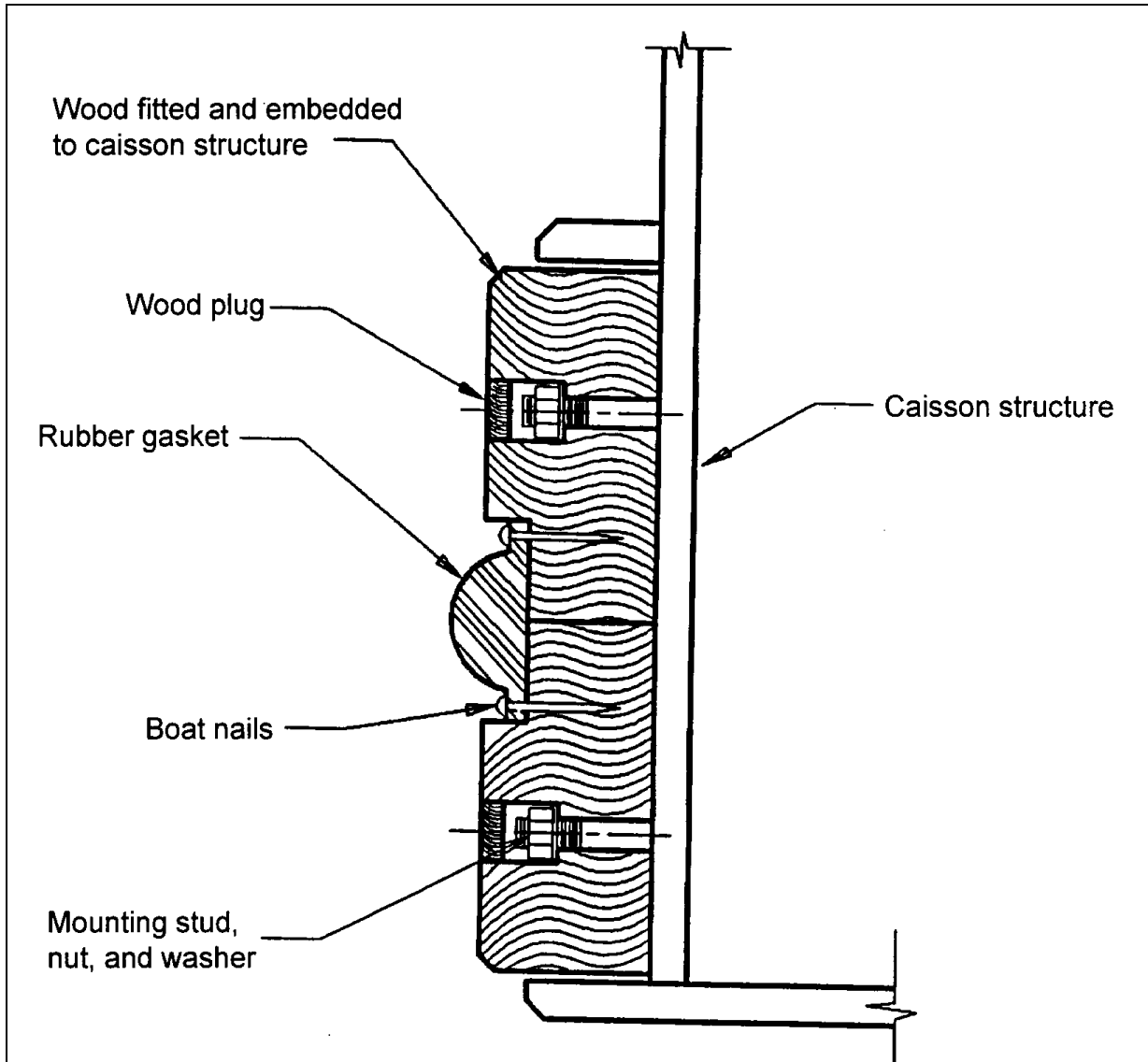
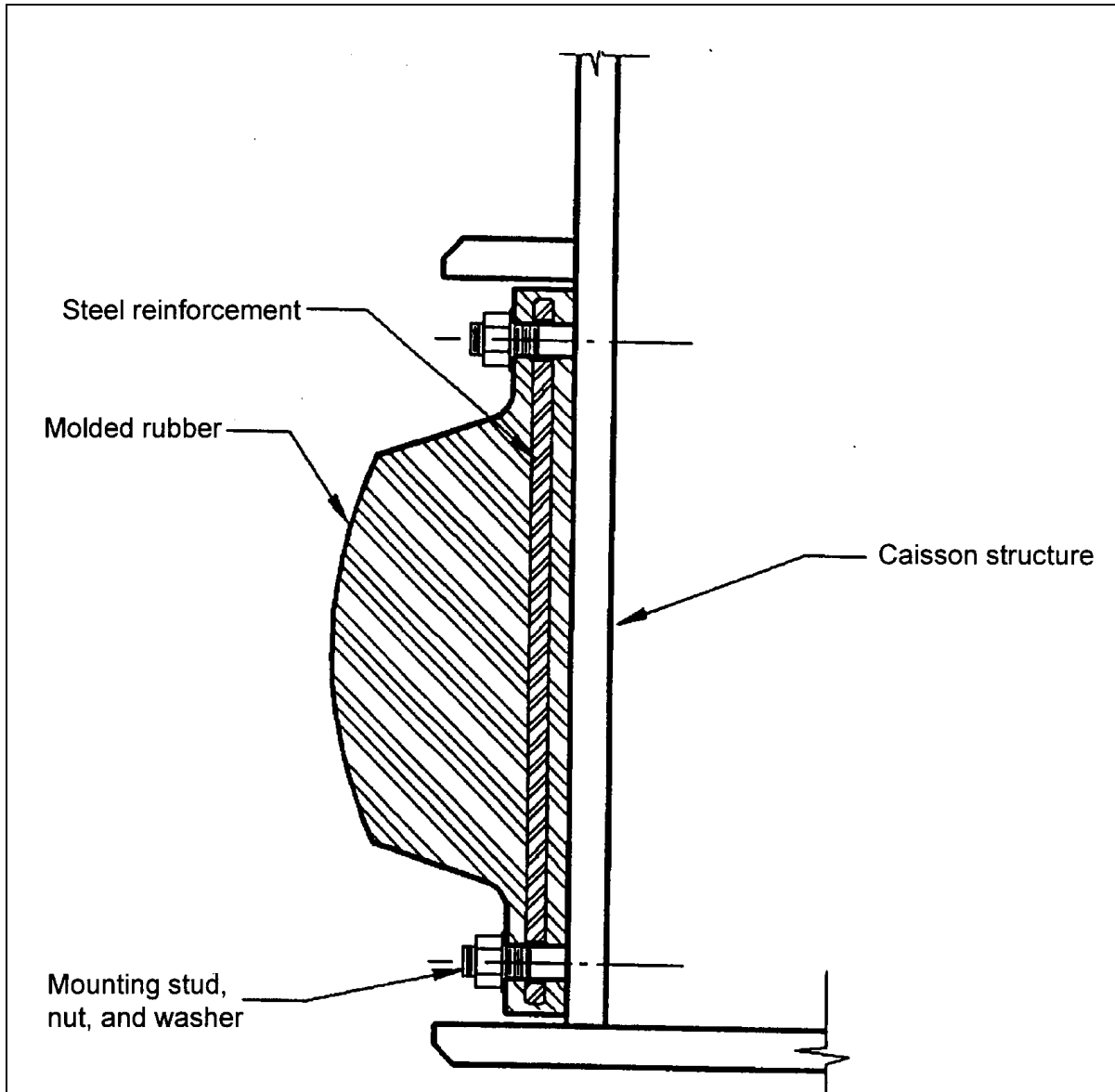

Figure 9-2 Steel Reinforced All-Rubber Caisson Seal Assembly



*This page intentionally left blank.*



## CHAPTER 10

### REPAIR OF BULKHEADS AND QUAYWALLS

10-1 **GENERAL.** Bulkheads and quaywalls are used as berthing facilities and thus are included in this handbook. Similar structures such as seawalls and breakwaters, designed primarily for coastal protection functions, are covered extensively in USACE manuals. Since the basic functions and designs of these structures overlap, there is considerable overlap in repair procedures.

Bulkheads and quaywalls are constructed primarily of sheet piling with soil fill overlaid with concrete or asphalt. Chapters 6 through 9 address the repair of sheetpiling. This section describes the repair of soil fill and overlay.

The common causes of damage to earth-filled structures are erosion by water and settlement due to undermining, washouts, etc. In addition, the sheet piling may deteriorate. Sheet piling repair procedures depend on the type of material used and are included in Chapter 8.

10-2 **PLANNING THE REPAIRS.** Before repairing earth-filled structures, consider the following:

- Scope of damage and/or deterioration.
- Rate of deterioration and overall age of the structure.
- Mission requirement for the structure.
- Operational constraints placed on the facility because of the deterioration.
- Changes to environmental conditions, such as currents, caused by other coastal or harbor changes.
- Alternatives for repairing the structure.

In many cases, usage requirements for the facility may have changed. Stone masonry bulkheads and earth-filled vertical bulkhead structures, as an example, may no longer be required for other than retaining the surrounding shoreline. The solutions may involve using riprap to shore up the structure or reduce seepage and loss of backfill, rather than performing expensive repairs to the structures.

Once the scope of repair requirements, including priorities, is established, then determine if the repairs should be done in-house or by contract.

10-3 **REPAIR PROCEDURES OF EARTH-FILLED STRUCTURES.** The procedures contained below describe the general approach involved in most repairs.

10-3.1 **Problem.** Erosion or settlement has occurred. Any breaching of, or impairment to, an earth structure exposed to moving water sharply increases its susceptibility to damage. For this reason it is critical that any required maintenance be identified and carried out as quickly as possible.

### 10-3.2 **Description of Repair/Maintenance**

10-3.2.1 **Replacing Soil.** Where there is evidence of erosion or loss of soil, protective coverings, such as rock fill or armor units, should be removed and the internal fill material inspected. Any necessary repairs in the form of replacement of properly compacted soil should be made, and the protective slope-covering replaced in a manner that ensures no further erosion. A series of soil layers of varying coarseness may be used to ensure that the finer, central materials cannot be washed out through the coarser, shell materials. The use of a geotextiles (see below) might be appropriate. In some cases, it may be economical to protect the side slopes with asphalt concrete, soil cement, or even reinforced Portland cement concrete. In cases where the side slopes are exposed only to atmospheric erosion, vegetation such as ice plant or grasses may be adequate.

10-3.2.2 **Geotextiles.** A rapidly emerging geotechnical engineering technology involves use of geotextiles for seepage and erosion control, and for soil strength reinforcement, see Koerner (Koerner, R. M. (1990), *Designing with Geosynthetics*, 2nd Edition, Prentice-Hall, Inc., Englewood Cliffs, NJ). Geotextiles are porous, flexible polymeric fabrics used for separating soil types, soil retention, and strength reinforcement. When used for soil retention, the fabric must meet permeability or permittivity requirements (ASTM D4491, *Test Methods for Water Permeability of Geotextiles by Permittivity*) relative to the permeability of the retained soil. Also the openings in the fabric must be small enough to impede loss of soil particles. This usually requires a fabric opening size not more than twice the 85% size of the soil (sieve size through which 85% of the soil grains will pass). Where a geotextile is used to provide drains for pressure relief, the transmissivity or flow capacity in the plane of the fabric is the important parameter.

Geotextile strength must also be considered in any design, see ASTM D4595, *Test Method for Tensile Properties of Geotextiles by the Wide Width Strip Method*. In order to prevent excess creep under load, geotextiles should have design strength factors of safety in the range of 2 to 4. This is particularly important where soil grids are used for the express purpose of reinforcing or strengthening the soil mass.

**10-3.2.3 Compaction Control.** The performance of soil embankments improves with density, so fill materials should generally be placed at as high a density as is economically feasible, particularly with the finer-grained soils at a density of at least 90% Proctor (ASTM D698, see below). Where the soil will be subjected to heavy loads, or where settlement of the fill would be undesirable, soil density should be increased, even up to 100% modified Proctor (ASTM D1557, see below). There is a specific moisture content for each soil type at which the maximum density is obtained under a specific compaction effort. Therefore, moisture control is an important factor in efficient compaction techniques, particularly with silts, clays, and mixed soils.

**10-3.2.3.1 Compaction Control Standards.** The two most common standards for compaction control are the standard Proctor (ASTM D698, *Test Methods for Laboratory Compaction Characteristics of Soil Using Standard Effort (12 400 ft lbf/ft<sup>3</sup> (600 kN m/m<sup>3</sup>)) /1/*) and the modified Proctor (ASTM D1557, *Test Methods for Laboratory Compaction Characteristics of Soil Using Modified Effort (56,000 ft lbf/ft<sup>3</sup> (2,700 kN m/m<sup>3</sup>)) /1/*) tests. The latter method represents a larger compactive effort than the former and has been adopted to account for the higher compactive capability of modern construction equipment. However, the standard considered most pertinent for waterfront structures is still the standard Proctor. This is because the lower compactive effort results in a slightly higher optimum moisture content for maximum density, and the higher moisture content is more compatible with the expected in-service conditions of waterfront structures.

**10-3.2.3.2 Compaction Selection.** The type of compaction selected should be based on the soil type. Vibratory compaction is more efficient with granular soils, whereas kneading types of equipment, such as sheepfoot rollers, are more applicable to cohesive soils. Vibratory rubber-tired compactors in the 24,250 to 30,865 pounds (11- to 14-metric ton) range are reasonably effective for all types of soil. Soil lifts should generally be limited to layers having a compacted thickness of no more than 5.9 inches (15 cm), except where it has been demonstrated that the compactors are capable of achieving the required densities throughout the full depth of thicker lifts. Such a situation might exist with a vibratory compactor on relatively clean, non-cohesive material. For backfilling sheet pile cofferdams or other structures with limited space, it may be necessary to use small hand-operated tampers or compactors. The difficulty of compaction generally increases with the decrease in grain size of the soil.

**10-3.2.3.3 Compaction Requirements.** A typical requirement for many waterfront structures is to specify a compacted density of 95 percent of standard Proctor, but this may vary with the type of structure and its present condition. It is desirable to place a soil material in a structure in as close to its long-term stable condition as possible. Although clean, granular materials should be placed in as saturated a condition as is practicable, fine-grained or mix-grained soils may

require moisture contents to be maintained within a particular optimum range. Often, control of water content with respect to the optimum value is left up to the contractor, since he can elect to replace rigorous moisture control with increased compactive effort. Where excess compactive effort could result in damage to the structure, such as in quaywalls or cofferdams, the compactive effort should be minimized and the moisture content controlled as well as is practicable. For these latter types of structures, it is also very important that design densities not be exceeded. Excessive compaction might result in undesirable lateral stresses in structural members.

**10-3.2.4 Dewatering.** Where excavation and replacement of soil takes place below the water table, it may be necessary to dewater the site by using seepage barriers, such as sheet piles. Where soil permeability is high, subsurface drainage by well points or deep wells may be necessary. Prior to planning dewatering procedures, it is necessary to determine permeability and piezometric levels by field observations. The major concern is to avoid instability through piping or heaving by controlling the upward hydraulic gradient at the base of the excavation. Hydraulic gradients (head loss per unit length of flowpath) equal to the ratio of buoyant density of the soil divided by the density of water lead to immediate instability in all cases. This ratio varies from  $> 1$  for dense soils to  $< 1$  for loose soils. Exit gradients of 0.5 to 0.75 will cause unstable working conditions even in clean sands. Silty materials are even more critical.

#### **10-3.2.5 Sealing/Filling Voids.**

**10-3.2.5.1 Sealing.** The loss of soil from behind quaywalls, or from within sheet pile cofferdams, requires sealing the structure to prevent further loss of material before replacing with a suitable backfill. Coarser-grained materials and/or geotextile filters are preferred, since they are less subject to leaching or erosion. Fine-grained materials are desirable only where very low permeability is required, such as in the core of an earth dam. When fine materials are used, construction of inverted geotextile filters and/or sealing of structural joints are necessary to prevent erosion. Where materials consist of the very erodible silts or fine sands, the structure must be sealed to prevent influx of surface water.

**10-3.2.5.2 Grouting.** In some cases, it may be more expedient to either seal or repair a damaged structure by injecting grout. Grout may be used to reduce the permeability of the soil fill or its foundation and, thereby, minimize erosion or leaching. It may also be used to physically strengthen the structure to make it more resistant to wave or ship loading, and superimposed dead loads.

Cavities or voids in the soil structure may be grouted using sand/water mixtures, Portland cement, clay, chemical grouts, or a combination of these materials depending on the size of voids. Sand/water mixtures are applicable where large cavities are present and the paths of soil loss have been sealed off. Cement grout is not applicable if the effective grain size of the in-place soils,  $D$  (the sieve

size through which only 10 percent of the soil would pass), is less than 19.7 mils (0.5 mm) for loose soils and 55.1 mils (1.4 mm) for dense soils. Portland cement grout is most applicable where the grout can be pumped directly into cavities.

An effective grouting procedure for sandy materials consists of injecting solutions of sodium silicate and calcium chloride. This procedure both solidifies the soil and makes it impermeable, but it is extremely expensive. Mixtures of cement and clay are also used, sometimes adding a chemical deflocculant.

One of the more recently developed chemical grouts polymerizes in the soil voids; however, it is also expensive. With fine-grained backfills, grouting is generally of no benefit except to fill cavities or to seal off paths of soil removal.

**10-3.2.6 Preventing Loss or Settlement of Soil.** Maintaining good surface drainage is the most important preventive maintenance measure for earthwork structures. Efficient runoff of rainfall and overflow water must be ensured. If subsurface drainage features exist, they must be kept clear (for example, periodic cleaning of weep holes). Hand-placed riprap can be added to the slope just behind the sheet piling, if storm runoff results in heavy soil loss.

**10-3.3 Future Inspection Requirements.** Where the rate of erosion or settlement has been increasing the structure must be closely monitored to provide early warning of impending failure. Where a major problem has been encountered and corrected, increased inspection may be necessary to ensure that the repair is effective.

*This page intentionally left blank.*

**APPENDIX A**

**REFERENCES**

**GOVERNMENT PUBLICATIONS**

<p>\1\ Unified Facilities Criteria (UFC):  <a href="http://dod.wbdg.org">http://dod.wbdg.org</a> /1/</p>	<p>\1\</p> <p>UFC 3-220-01N, Geotechnical Engineering Procedures for Foundation Design of Buildings and Structures</p> <p>UFC 3-220-10N, Soil Mechanics</p> <p>UFC 3-301-01, Structural Engineering</p> <p>UFC 3-570-02N, Electrical Engineering Cathodic Protection</p> <p>UFC 4-150-08, Inspection of Mooring Hardware</p> <p>UFC 4-151-10, General Criteria for Waterfront Construction</p> <p>UFC 4-152-01, Design: Piers and Wharves</p> <p>UFC 4-213-10, Design: Graving Drydocks</p> <p>UFC 4-213-12, Drydocking Facilities Characteristics</p> <p>/1/</p>
<p>\1\ Unified Facilities Guide Specifications  <a href="http://dod.wbdg.org">http://dod.wbdg.org</a> /1/</p>	<p>\1\</p> <p>UFGS 03 31 29, Marine Concrete</p> <p>UFGS 06 13 33, Pier Timberwork</p> <p>UFGS 09 97 13.26, Coating of Steel Waterfront Structures</p> <p>UFGS 31 62 13.13, Cast-In-Place Concrete Piles</p>

	<p>UFGS 31 62 13.20, Precast/Prestressed Concrete Piles</p> <p>UFGS 31 62 19.13, Wood Marine Piles</p> <p>UFGS 35 59 13.13, Prestressed Concrete Fender Piling</p> <p>/1/</p>
<p>U.S. Navy, Office of the Chief of Naval Operations</p>	<p>OPNAVINST 5090.1, Environmental and Natural Resources Program Manual</p> <p>OPNAVINST 5100.23, Navy Occupational Safety and Health Program Manual</p>
<p>\1\ Navy Crane Center Norfolk Naval Shipyard Bldg 491 Portsmouth, VA 23709 <a href="https://portal.navfac.navy.mil/portal/page/portal/navfac/navfac_ww_pp/navfac_ncc_pp/tab33578">https://portal.navfac.navy.mil/portal/page/portal/navfac/navfac_ww_pp/navfac_ncc_pp/tab33578</a> /1/</p>	<p>\1\ P-307, Management of Weight Handling Equipment Maintenance and Certification./1/</p>
<p>\1\NAVFAC ATLANTIC 6506 Hampton Blvd Norfolk, VA 23508-1278 <a href="http://www.wbdg.org/ccb/browse_cat.php?c=86">http://www.wbdg.org/ccb/browse_cat.php?c=86</a> /1/</p>	<p>MO 104.1, Maintenance of Fender Systems and Camels</p> <p>MO 124, Mooring Maintenance Manual</p> <p>\1\ MO 104.2, Specialized Underwater Waterfront Facilities Inspections /1/</p> <p>MO 312.2, A Field Guide for the Receipt and Inspection of Treated Wood Products by Installation Personnel</p> <p>MO 321, Facilities Management</p> <p>MO 322, Inspection of Shore Facilities (Vol 1 and 2)</p>



<p>           Naval Facilities Engineering Service Center            1100 23<sup>rd</sup> Avenue            Port Hueneme CA 93043-4370            \1\ <a href="https://portal.navfac.navy.mil/portal/page/portal/navfac/navfac_ww_pp/navfac_NFESC_pp/1/">https://portal.navfac.navy.mil/portal/page/portal/navfac/navfac_ww_pp/navfac_NFESC_pp/1/</a> </p>	<p>           Contract Report CEL-CR-81.009, Survey of Techniques for Underwater Maintenance/Repair of Waterfront Structures, February 1981 by Childs Engineering Corporation             Survey of Techniques for Underwater Maintenance /Repair of Waterfront Structures, Revision No. 1, December 1985 by Childs Engineering Corporation             NCEL TM-43-85-01CR, UCT Conventional Inspection and Repair Techniques Manual, October 1984             NCEL CR 87-005, Inspection Frequency Criteria Models for Timber, Steel, and Concrete Pile Supported Waterfront Structures, November 1986             NCEL TN-1762, Sampling Criteria and Procedures for Inspection of Waterfront Facilities, September 1988             \1\ NTRP 4-04.2.8, Conventional Underwater Construction and Repair Techniques /1/             \1\ NTRP 4-04.2.9, Expedient Underwater Construction and Repair Techniques /1/         </p>
<p>           U.S. Army Corps of Engineers  <a href="http://www.hnd.usace.army.mil/techinfo">www.hnd.usace.army.mil/techinfo</a> </p>	<p>           \1\ AR 200-1, Environmental Protection and Enhancement /1/             AR 415 Series             AR 420-10 Series             Shore Protection Manual, Vol 1 and 2             EM-1110-2-1614, Design of Coastal Revetments, Seawalls, and Bulkheads         </p>

	<p>EM-1110-2-2904, Design of Breakwaters and Jetties</p> <p>EM-1110-2-1204, Environmental Engineering for Coastal Protection</p> <p>EM-1110-2-1414, Water Levels and Wave Heights for Coastal Engineering Design</p> <p>EM-1110-2-2302, Construction with Large Stone</p> <p>EM-1110-2-1617, Coastal Groins and Nearshore Breakwaters</p> <p>EM-385-1-1, Safety and Health Requirements Manual</p> <p>EM-1110-2-1004, Coastal Project Monitoring</p> <p>ER-1110-2-2902, Prescribed Procedures for the Maintenance and Operation of Shore Protection Works</p>
<p>Air Force  \1\ <a href="http://www.e-publishing.af.mil/">http://www.e-publishing.af.mil/</a> /1/</p>	<p>Air Force Instruction 32-1023, Design and \1\ Constructing Military /1/ Construction Projects</p> <p>AFPD 91-3, Occupational Safety and Health</p>
<p>Defense Standardization Program  <a href="http://www.dsp.dla.mil">www.dsp.dla.mil</a></p>	<p>MIL-STD-889B, Dissimilar Metals</p>

**NON-GOVERNMENT PUBLICATIONS**

<p>ACI International (ACI)          PO Box 9094          Farmington Hills, MI 48333  <a href="http://www.aci-int.org">www.aci-int.org</a></p>	<p>ACI 211, Recommended Practice for          Selecting Proportions for Concrete</p> <p>ACI Standard 318, Building Code          Requirements for \1\ Structural /1/          Concrete</p> <p>\1\ ACI SP-14, Shotcreting /1/</p>
<p>American Institute of Steel          Construction          One East Wacker Drive, Suite 3100          Chicago, IL 60601-2001  <a href="http://www.aisc.org">www.aisc.org</a></p>	<p>LRFD Manual of Steel Construction,          2<sup>nd</sup> edition</p> <p>LRFD Manual of Steel Construction,          Metric Conversion, 2<sup>nd</sup> edition</p> <p>ASD Manual of Steel Construction, 9<sup>th</sup>          edition</p>
<p>American Society for Testing Materials          (ASTM)          100 Bar Harbor Drive          West Conshohocken, PA 19428-2959  <a href="http://www.astm.org">www.astm.org</a></p>	<p>\1\          ASTM A36/A36M, Specification for          Carbon Structural Steel</p> <p>ASTM A242/A242M, Specification for          High-Strength, Low-Alloy Structural          Steel</p> <p>ASTM A572/A572M, Specification for          High-Strength, Low-Alloy Columbian-          Vanadium Steels Structural Steel</p> <p>ASTM A615/A615M, Specification for          Deformed and Plain Carbon-Steel          Bars for Concrete Reinforcement</p> <p>\1\ /1/          ASTM A690/A690M, Specification for          High-Strength Low-Alloy Nickel,          Copper, Phosphorus Steel H-Piles and          Sheet Piling with Atmospheric          Corrosion Resistance for Use in Marine          Environments</p>

	<p>ASTM A775/A775M, Specification for Epoxy Coated Steel Reinforcing Bars</p> <p>ASTM A996/A996M, Specification for Rail-Steel and Axle-Steel Deformed Bars for Concrete Reinforcement</p> <p>ASTM B370, Specification for Copper Sheet and Strip for Building Construction</p> <p>ASTM C150 / C150M, Specification for Portland Cement</p> <p>ASTM C157/C157M, Test Method for Length Change of Hardened Hydraulic Cement Mortar and Concrete</p> <p>ASTM C233 / C233M, Test Method for Air Entraining Admixtures for Concrete</p> <p>ASTM C330/C330M, Specification for Lightweight Aggregates for Structural Concrete</p> <p>ASTM C494/C494M, Specification for Chemical Admixtures for Concrete</p> <p>ASTM C876, Corrosion Potentials of Uncoated Reinforcing Steel in Concrete</p> <p>ASTM C920, Specification for Elastomeric Joint Sealants</p> <p>ASTM D698, Test Methods for Laboratory Compaction Characteristics of Soil Using Standard Effort (12 400 ft lbf/ft<sup>3</sup> (600 kN m/m<sup>3</sup>))</p> <p>ASTM D1557, Test Methods for Laboratory Compaction Characteristics of Soil Using Modified Effort (56,000 ft lbf/ft<sup>3</sup> (2,700 kN m/m<sup>3</sup>))</p>
--	--

	<p>ASTM D4022/D4022M, Specification for Coal Tar Roof Cement, Asbestos Containing</p> <p>ASTM D4491, Test Methods for Water Permeability of Geotextiles by Permittivity</p> <p>ASTM D4595, Test Method for Tensile Properties of Geotextiles by the Wide Width Strip Method</p> <p>/1/</p>
<p>\1\ American Wood Protection Association (AWPA)  P.O. Box 36784  Birmingham, AL 35236-1784  <a href="http://www.awpa.com">www.awpa.com</a> /1/</p>	<p>\1\ Standard U1, Use Category System: User Specification for Treated Wood /1/</p>
<p>Portland Cement Association  5420 Old Orchard Road  Skokie IL 60077  <a href="http://www.cement.org">www.cement.org</a></p>	<p>Principles of Quality Concrete</p>
<p>\1\ Southern Forest Products Association  2900 Indiana Avenue  Kenner, LA 70065-4464 /1/  <a href="http://www.southernpine.com">www.southernpine.com</a></p>	<p>Marine Construction Manual: A Guide to Using Pressure-Treated Southern Pine in Fresh and Saltwater Applications, October 1994</p>
<p>Sheffer, T.C.  Information Services,  USDA Forest Service  Forest Products Laboratory  One Gifford Pinchot Drive  Madison, WI 53705-2398  <a href="http://www.fpl.fs.fed.us">www.fpl.fs.fed.us</a></p>	<p>Observations and Recommendations Regarding Decay in Naval Waterfront Structures, September 1996</p>
<p>Morrell, J.J. et. al  Oregon State University  College of Forestry  <a href="http://www.forestry.oregonstate.edu/">http://www.forestry.oregonstate.edu/</a></p>	<p>Marine Wood Maintenance Manual: A Guide for Proper Use of Douglas fir in Marine Exposures, Forest Research Laboratory Bulletin 48, October 1984</p>
<p>International Concrete Repair Institute  \1\ 10600 West Higgins Road, Suite 607,  Rosemont, IL 60018 /1/  <a href="http://www.icri.org">www.icri.org</a></p>	<p>ICRI No. 210.1, Guide for Verifying Field Performance of Epoxy Injection of Concrete Cracks (formerly No. 03734)</p>