

WELDER'S VISUAL INSPECTION HANDBOOK

MAY 2013

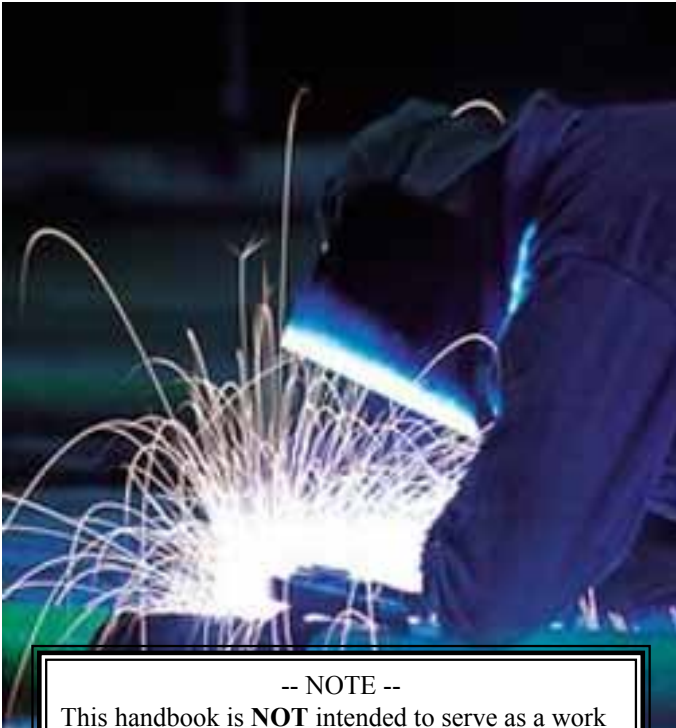

-- NOTE --

This handbook is **NOT** intended to serve as a work procedure or to replace any existing procedures. It is solely intended to provide basic information about weld conditions, weld gauges, symbols and weld terms. Refer to local procedures for technical or other specific data.



Click on any of the items under the Table of Contents to go to that

| Table of Contents | Page |
|--|------|
| Visual Inspection Responsibilities and Technique _____ | i |
| How to Measure Fillet Weld Size _____ | 1 |
| VT Attributes | |
| Cracks _____ | 2 |
| Underfill _____ | 4 |
| Burn Through _____ | 6 |
| Incomplete Fusion _____ | 8 |
| Roughness _____ | 10 |
| Overlap _____ | 12 |
| Undersized Fillet Weld _____ | 14 |
| Incomplete Penetration _____ | 16 |
| Undercut _____ | 18 |
| Corner-Melt _____ | 20 |
| End-Melt _____ | 22 |
| Concave Fillet Weld _____ | 24 |
| Convex Fillet Weld _____ | 26 |
| Arc Strikes _____ | 28 |
| Other Fabrication Scars _____ | 30 |
| Porosity _____ | 32 |
| Spatter _____ | 34 |
| Slag _____ | 36 |
| Weld Reinforcement _____ | 38 |
| Melt Through _____ | 40 |
| Offset _____ | 42 |
| Oxidation _____ | 44 |
| Crater Pit _____ | 46 |
| Paint _____ | 48 |
| Types of Weld Joints _____ | 50 |
| Parts of a Weld _____ | 53 |
| Structural Joint Numbering System _____ | 54 |
| Standard Welding Symbol Layout _____ | 60 |
| Standard Welding Symbols _____ | 61 |
| Using Finger Gauge _____ | 67 |
| Using Bridgecam Gauge _____ | 70 |
| Definitions _____ | 73 |

Visual Inspection Responsibilities

1. **When** – Final visual inspections must be performed:
 - a) When the weld is complete, and in the final surface and heat treated conditions
 - b) Before other NDT (when required)
 - c) Before being made inaccessible for inspection
2. **Where** – the weld inspection zone:
 - a) All work - Completed weld faces plus ½ inch on both sides of weld shall be visually inspected for the entire length of the weld.
 - b) To gauge weld size:
 - (1). Gauge where the weld size visually appears to be the smallest
 - (2). If the weld length is five feet or less, gauge a minimum of once per weld
 - (3). If the weld length is greater than five feet, gauge a minimum of once every five feet

Visual Inspection Technique

1. **What** – In order to perform final visual inspection you need:
 - a) Adequate lighting (use flashlight as needed)
 - b) Weld gauges (bridge cam and finger gauges recommended)
 - c) Prescription glasses (as required)
2. **How** – Distance and angle:
 - a) The inspector's eyes should be within 24 inches of the surface to be inspected **and**
 - b) At an angle of at least 30 degrees to the surface being inspected.

How to Measure FILLET WELD SIZE (Correct Size)

The leg lengths and throat of the largest triangle that can be drawn within the fillet weld cross section.

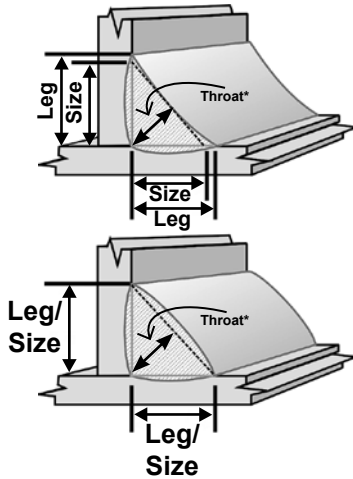

* See parts of a weld

CRACKS

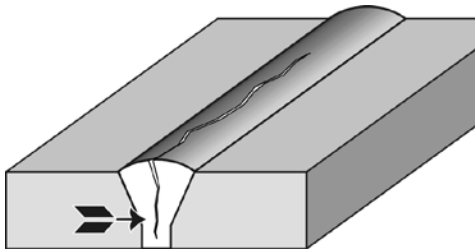

CRACKS

Definition

A tear, fracture or fissure in the weld or base metal appearing as a broken, jagged or straight line.

NOTE: Cracks are the most serious defect!

Preventive Action

1. Remove contaminants from the joint (rust, grease, moisture, etc.) prior to welding.
2. Apply and maintain required preheat.
3. Do not allow the base material to cool too quickly.
4. Maintain filler metal control requirements.
5. Use correct filler metal type for the joint.
6. Apply proper bead size and sequencing to eliminate excessive distortion and/or stress in the base material.

Corrective Action

Repair in accordance with local procedures.

UNDERFILL

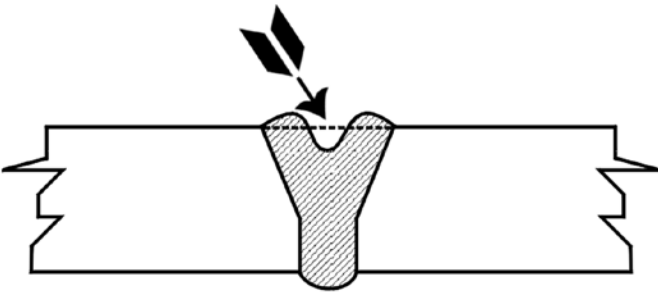
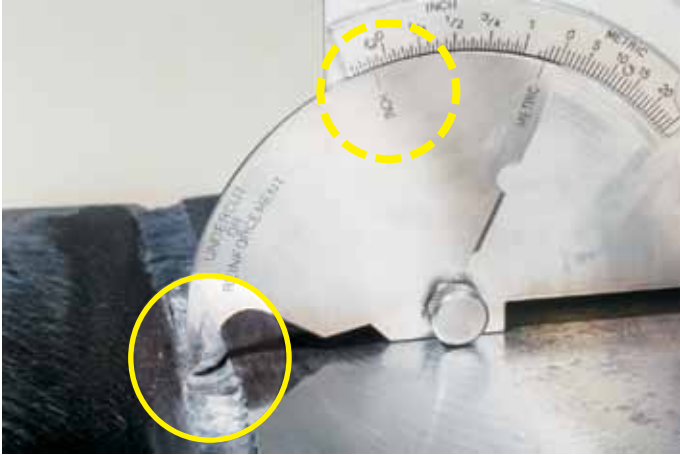

UNDERFILL

Definition

The amount of weld that is below a straight line drawn from the edges of the joint preparation of a groove weld, with the exception of allowable undercut.

Preventive Action

1. During welding of the reinforcement, gauge bead heights in any location that appears to be lower than the rest of the bead.
2. Adjust amps/volts.
3. Slow travel speed to allow increased weld puddle volume.
4. Sequence weld passes so that the toes of the beads sufficiently cover one another, minimizing valleys.

Corrective Action

Apply additional weld beads until the joint is adequately filled. (flush or above)

BURN THROUGH

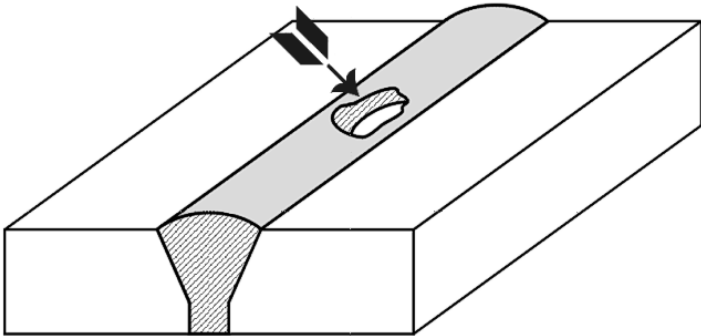

BURN THROUGH

Definition

Excessive heat and/or penetration that results in a hole completely through the backing ring or strip, fused root, or adjacent base material.

Preventive Action

1. Reduce amps/volts.
2. Increase travel speed.
3. Maintain appropriate arc length/wire stickout.
4. Use ceramic tape or approved metal backing strap on areas with root gap.

Corrective Action

1. Place ceramic tape or approved metal backing strap on the bottom side of the hole.
2. Weld repair the first side of the hole from the easiest side to weld.
3. Once sufficient weld metal has been deposited on the easiest top side, grind or carbon arc the other side of the hole to sound metal.
4. Weld the other side of the hole to the appropriate size or height.

INCOMPLETE FUSION

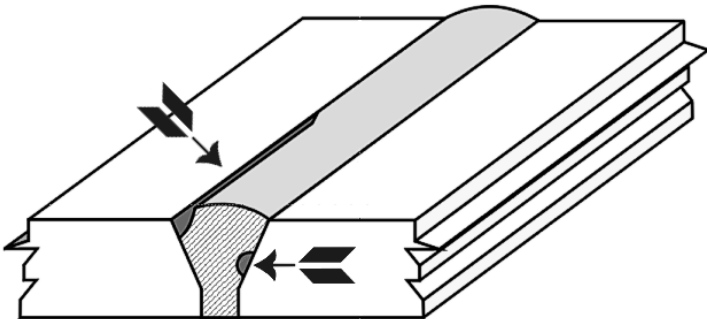
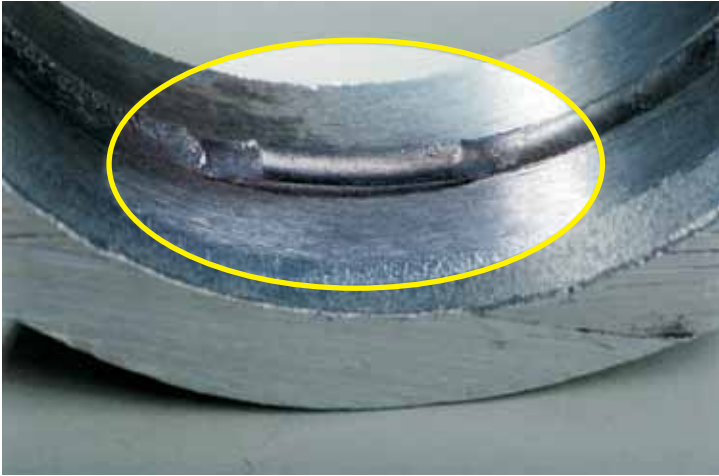

INCOMPLETE FUSION

Definition

A situation where the weld metal does not fuse or completely bond with the base metal or previously deposited weld metal.

Preventive Action

1. Increase amps/volts.
2. Decrease travel speed.
3. Maintain appropriate arc length/wire stickout.
4. Adjust torch/rod angle.
5. Ensure previous beads are free of overlap (bead roll-over) and slag prior to welding additional passes.

Corrective Action

1. Grind or carbon arc the weld to sound metal.
2. Weld repair the affected area.

ROUGHNESS

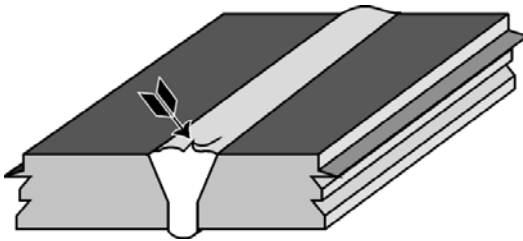

ROUGHNESS

Definition

Sharp ridges (irregularities) or deep valleys between weld beads. The angle formed between the adjacent beads of the weld must be 90° or greater.

Preventive Action

1. Adjust amps/volts.
2. Maintain a consistent travel speed.
3. Maintain appropriate arc length/wire stickout.
4. Adjust torch/rod angle.
5. Sequence weld passes so that the toes of the beads sufficiently cover one another, minimizing valleys.
6. Consult local Welding Engineering in cases where the base material is magnetized.

Corrective Action

1. Grind or carbon arc the weld to sound metal.
2. Weld repair the affected area, if needed.

OVERLAP

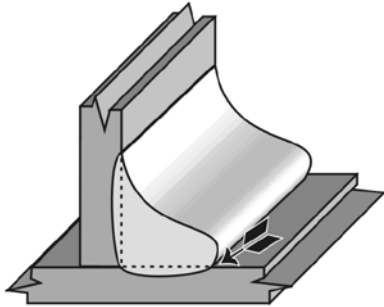

OVERLAP

Definition

A condition where the weld metal rolls over forming an angle less than 90°. Sometimes referred to as “weld bead rollover.”

Preventive Action

1. Adjust amps/volts.
2. Increase travel speed.
3. Maintain appropriate arc length/wire stickout.
4. Adjust torch/rod angle.

Corrective Action

1. Grind or carbon arc the weld to sound metal.
2. Weld repair the affected area, if needed.

UNDERSIZED FILLET WELD

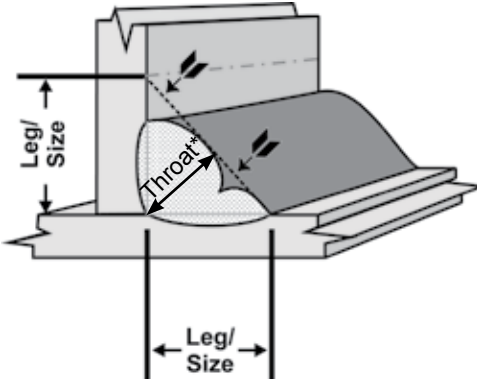

* See parts of a weld

UNDERSIZED FILLET WELD

Definition

Any fillet or fillet reinforced weld that does not meet the minimum size requirements specified on applicable fabrication documents.

Note: Skewed fillets are exceptionally prone to having undersized weld on sides that have greater than 90° joint fit-up.

Preventive Action

1. Apply weld layers until weld size is met on all sides of joint.
2. Adjust amps/volts.
3. Decrease travel speed.
4. Maintain proper wire stickout.
5. Adjust torch/rod angle.
6. Avoid over grinding.
7. Sequence weld passes so that the toes of the beads sufficiently overlap one another.

Corrective Action

Apply additional weld passes until the affected areas are the proper size.

INCOMPLETE PENETRATION

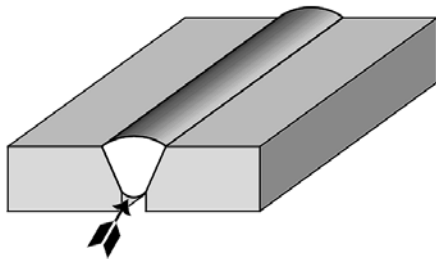
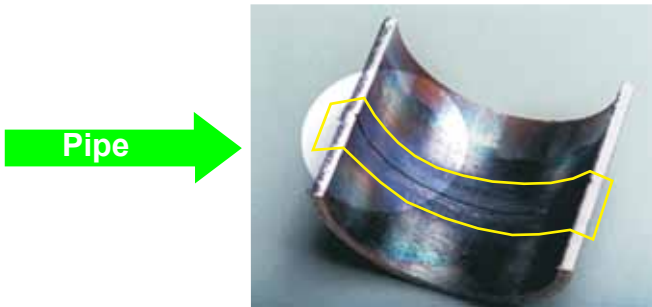

INCOMPLETE PENETRATION

Definition

A situation where the weld metal does not penetrate as deeply as required.

Preventive Action

1. Increase the bevel angle and/or root opening of the fit-up. Do not exceed the requirements of the joint design.
2. Ensure bevel edges of both members are lined up properly.
3. Increase amps/volts.
4. Decrease travel speed.
5. Maintain appropriate arc length/wire stickout.
6. Adjust torch/rod angle.

Corrective Action

1. Grind or carbon arc the weld to sound metal.
Note: Backgouge 2nd side to full penetration (remove fusion lines). Often, more than one fusion line will be present during back gouging.
2. Weld repair the affected area.

UNDERCUT

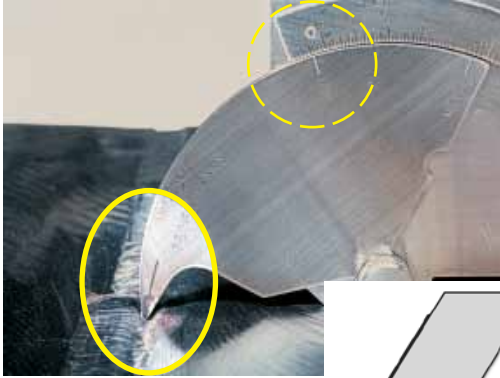

BRIDGECAM

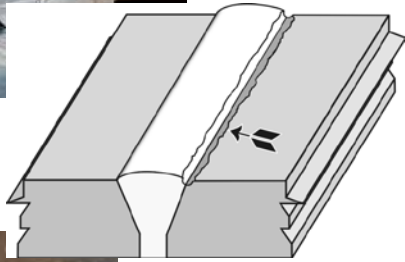

UNDERCUT GAUGE

| | |
|-------------------------|----------------|
| $\frac{1}{32}$ | $\frac{3}{64}$ |
| $\bigcirc \frac{1}{64}$ | $\frac{1}{16}$ |

UNDERCUT

Definition

A groove melted into the base metal and left unfilled by weld metal.

Preventive Action

1. Decrease amps/volts.
2. Decrease travel speed.
3. Maintain appropriate arc length/wire stick-out.
4. Adjust torch/rod angle.
5. Feed more wire into the puddle when manual TIG welding.
6. Increase stop time (dwell time) on weaved beads.
7. Use undercut gauge to verify acceptability.

Corrective Action

1. Grind the toe of the weld until the unacceptable undercut blends smoothly into the base material.
2. Weld repair the affected area, if needed.

CORNER-MELT



**“as is”
condition**



**ground
condition**

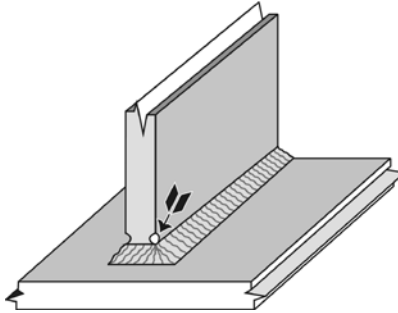

CORNER-MELT

Definition

A groove melted in a corner of a welded member that is left unfilled.

Preventive Action

1. Start welds at end of joint and work inward.
2. Decrease amps/volts.
3. Decrease travel speed.
4. Maintain appropriate arc length/wire stick-out.
5. Adjust torch/rod angle.
6. Feed more wire into the puddle when manual TIG welding.
7. Increase stop time (dwell time) on weaved beads.
8. Use undercut or bridgecam gauge to verify acceptability.

Corrective Action

1. Grind the toe of the weld until the unacceptable corner-melt blends smoothly into the base material.
2. Weld repair the affected area, if needed.

END-MELT



“as is” condition



ground condition



Gauged

1/4" or less →

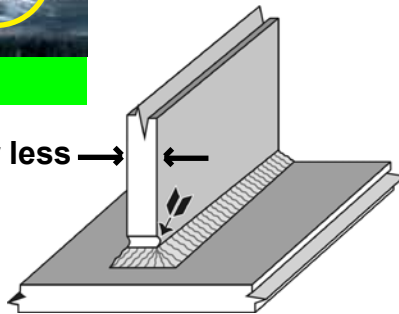

END-MELT

Definition

A groove melted into the end of a ¼ inch or less welded member that is left unfilled by weld metal.

Preventive Action

1. Start the weld passes at the ends, where possible.
2. Decrease amps/volts.
3. Decrease travel speed.
4. Maintain appropriate arc length/wire stick-out.
5. Adjust torch/rod angle.
6. Feed more wire into the puddle when manual TIG welding.
7. Increase stop time (dwell time) on weaved beads.
8. Use undercut or bridgcam gauge to verify acceptability.

Corrective Action

1. Grind the toe of the weld until the unacceptable end-melt blends smoothly into the base material.
2. Weld repair the affected area, if needed.

CONCAVE FILLET WELD



gauged

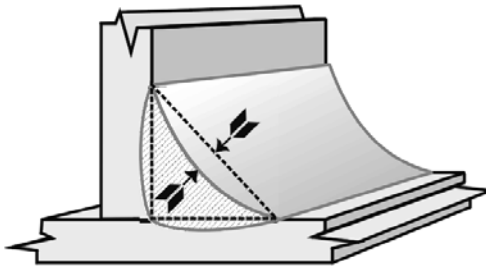

CONCAVE FILLET WELD

Definition

A fillet weld that sinks in the center.

Preventive Action

1. Adjust amps/volts.
2. Decrease travel speed.
3. Maintain appropriate arc length/wire stickout.
4. Adjust torch/rod angle.
5. Feed more wire into the puddle when manual TIG welding.
6. Increase stop time (dwell time) on weaved beads.
7. Sequence weld passes so that the toes of the beads sufficiently cover one another.

Corrective Action

Apply additional weld passes until the concavity requirements have been met.

CONVEX FILLET WELD

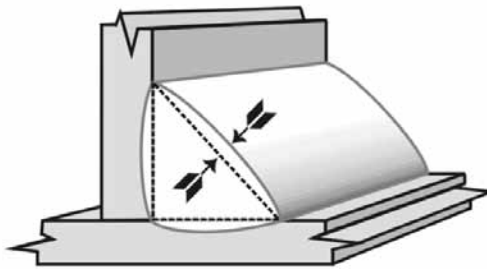
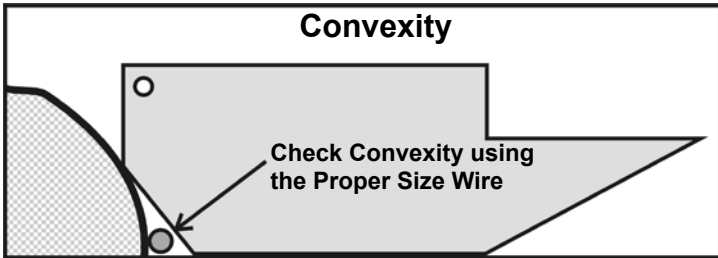

CONVEX FILLET WELD

Definition

A fillet weld that bulges out in the center.

Preventive Action

1. Adjust amps/volts.
2. Increase travel speed.
3. Maintain proper wire stickout.
4. Adjust torch/rod angle.
5. Feed less wire into the puddle when manual TIG welding.
6. On multiple pass welds, avoid placing beads too close together.

Corrective Action

Grind, carbon arc or weld the affected area until the convexity requirements have been met.

ARC STRIKES

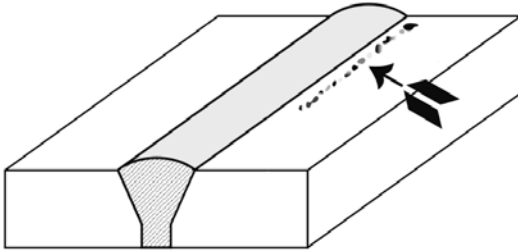

ARC STRIKES

Definition

A discontinuity consisting of any localized re-melted metal, heat effected metal, or change in surface profile of a finished weld or base material surface resulting from an electrical arc.

Note: Arc strikes may develop stress risers, which could lead to cracking.

Preventive Action

1. Prior to energizing welding equipment, replace damaged welding lines and ground cables.
2. Ensure grounds are properly installed.
3. Hang lines on trees or J-hooks.
4. Keep gas cups free of weld spatter on flux core processes.
5. Do not allow sub-arc tips to contact the base material.
6. Be careful when striking an arc.

Corrective Action

1. Grind the affected area until the unacceptable arc strike blends smoothly into the base material or weld face.
2. Weld repair the affected area, if needed.

OTHER FABRICATION SCARS

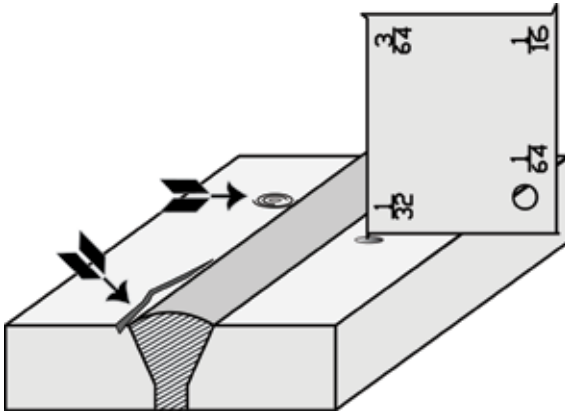
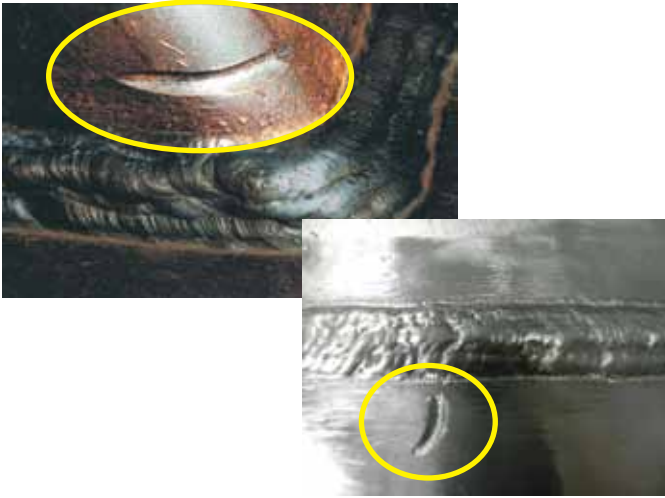

OTHER FABRICATION SCARS

Definition

Any accidental groove or cut that penetrates the surface of the metal. Sometimes called nicks, gouges or handling marks.

Preventive Action

1. Avoid dropping heavy or sharp objects on welds and surrounding base material.
2. Be careful when grinding, carbon arcing or using scaling hammer.
3. Use undercut gauge to verify scar acceptability.

Corrective Action

1. Grind the affected area until the unacceptable fabrication scar blends smoothly into the base material or weld face.
2. Weld repair the affected area, if needed.

POROSITY

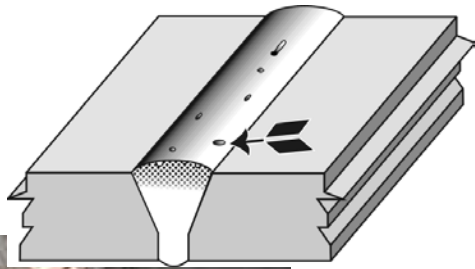

POROSITY

Definition

Open holes formed by gas that was trapped when the weld cooled. Sometimes called “pin-holes.”

Preventive Action

1. Remove contaminants from the joint (rust, grease, moisture, etc.) prior to welding.
2. Maintain filler metal control requirements.
3. Maintain appropriate arc length/wire stickout.
4. Adjust torch/rod angle.
5. Use the largest size gas cup possible and keep it free of spatter.
6. Position wind screens between the welding operation and any heavy flow of air.

Corrective Action

1. Completely remove porosity from all intermediate weld areas.
2. Grind or carbon arc the affected area until the unacceptable porosity is removed from the weld.
3. Weld repair the affected area, if needed.

SPATTER

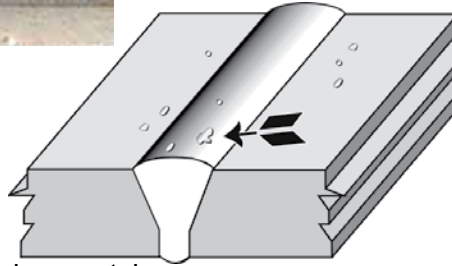

A 1/8" wide x 1/8" deep notch
is for verifying size of spatter



SPATTER

Definition

The metal particles expelled during welding that do not form a part of the weld.

Preventive Action

1. Remove contaminants from the joint (rust, grease, moisture, etc.) prior to welding.
2. Maintain filler metal control requirements.
3. Use Refrasil to protect surrounding surfaces from secondary weld spatter.
4. Adjust amps/volts.
5. Adjust torch/rod angle.
6. Maintain appropriate arc length/wire stickout.
7. Use ceramic tape or approved metal backing strap on areas with root gap.
8. Consult local Welding Engineering in cases where the base material is magnetized.

Corrective Action

1. Completely remove spatter from all intermediate weld areas.
2. Remove all loose spatter with a needle gun.
3. Grind all **tightly adhering, unacceptable spatter** until it blends smoothly into the base material or weld.

SLAG



A 1/8" wide x 1/8" deep notch is for verifying size of slag

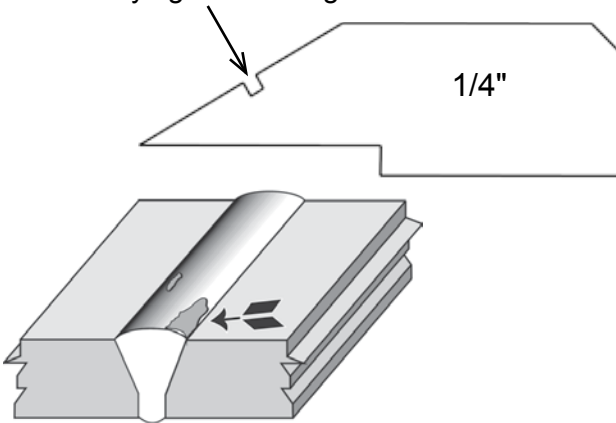

SLAG

Definition

The nonmetallic layer that forms on top of the molten metal.

Preventive Action

Note: Slag is a byproduct of the welding process that cannot be prevented. Below are some actions that make slag removal easier.

1. Adjust amps/volts.
2. Maintain a consistent travel speed.
3. Maintain an appropriate arc length/wire stick-out.
4. Adjust torch/rod angle.
5. Sequence weld passes so that the toes of the beads sufficiently overlap one another, minimizing valleys.

Corrective Action

1. Completely remove slag from all intermediate weld areas.
2. Remove all loose slag with a needle gun.
3. Grind all **tightly adhering, unacceptable slag** from the surface of the base material or weld.

WELD REINFORCEMENT

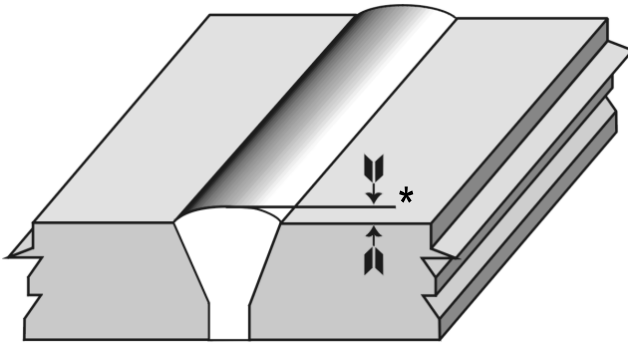
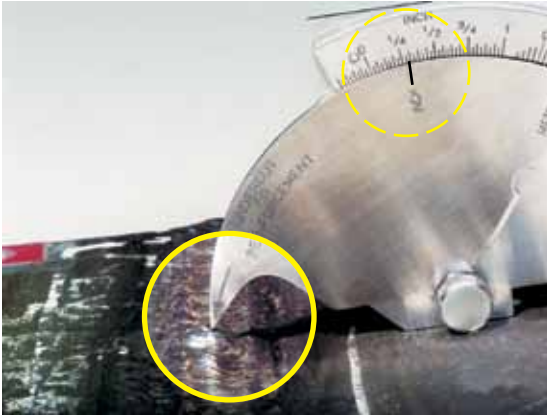

* Check local procedures for areas that have height restrictions.

WELD REINFORCEMENT

Definition

The amount of weld that is above a straight line drawn from the edges of the joint preparation of a groove weld.

Preventive Action

1. Adjust amps/volts.
2. Increase travel speed.
3. Maintain appropriate wire stickout.
4. Adjust torch/rod angle.
5. Sequence beads so that the toes do not excessively overlap one another, creating high spots in the reinforcement.

Corrective Action

Grind or carbon arc areas of weld reinforcement that exceed the maximum allowable height (if applicable).

MELT THROUGH

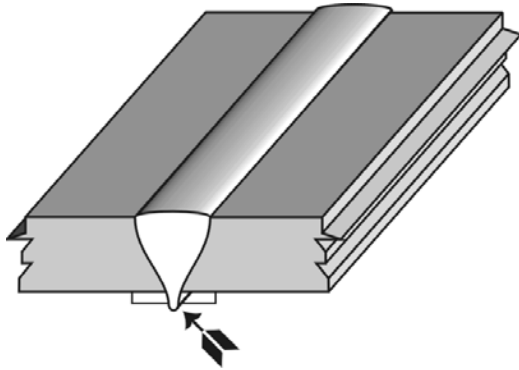

MELT THROUGH

Definition

Excessive heat and/or penetration that results in irregularity on the surface of the backing ring or strip, fused root or adjacent base material.

Preventive Action

1. Reduce amps/volts.
2. Increase travel speed.
3. Maintain appropriate arc length/wire stick-out.
4. Use ceramic tape or approved metal backing strap on areas with root gap.

Corrective Action

1. Grind or carbon arc the weld to sound metal.
2. Weld repair the affected area, if needed.

OFFSET

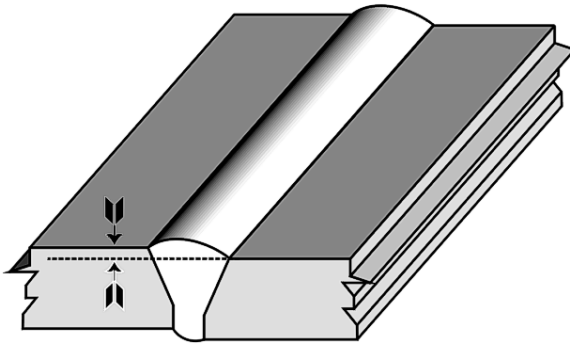
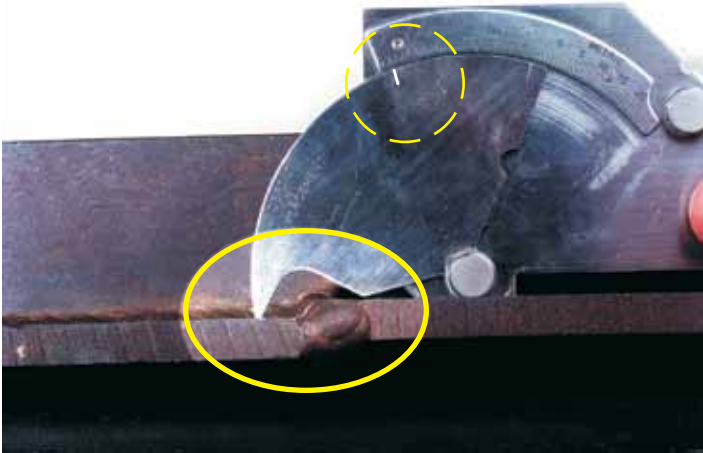

OFFSET

Definition

A situation where base materials creating a butt or corner joint have moved out of alignment or position. Sometimes called “misalignment.”

NOTE: Offset is one of the major causes of in-service failures!

Preventive Action

1. Ensure installing trade provides proper fit-up prior to welding.
2. Use approved temporary attachments (strongbacks, flatbar, etc.), as needed to reduce distortion.
3. Gauge for offset acceptability prior to tack welding with bridgcam or finger gauges.
4. Apply sufficient block tacks prior to welding.

Note: Stop welding and immediately notify your foreman anytime unacceptable offset occurs.

Corrective Action

1. Installing trade may have to cut apart and re-fit the joint within tolerance.
2. Offset may be repaired by applying weld build-up to the appropriate taper.

OXIDATION

copper-nickel



steel

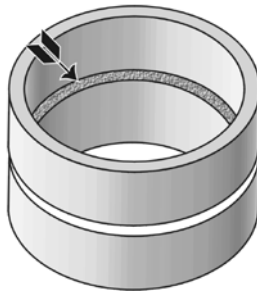
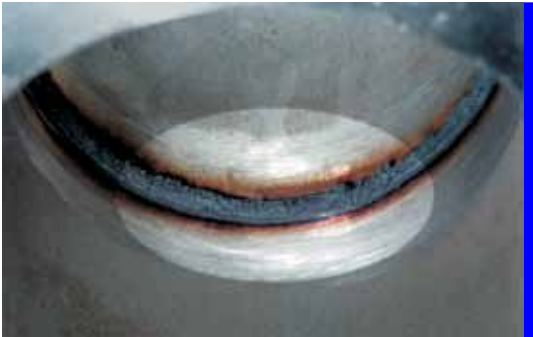

OXIDATION

Definition

A condition resulting from partial or complete lack of purge of a surface which is heated during welding resulting in formation of oxide on the surface. This condition may range from slight oxidation evidenced by a multicolored or tightly adhering black film to the extreme of a very rough surface having crystalline appearance (referred to as “sugaring.”)

Preventive Action

1. Ensure adequate pipe purge is maintained prior to and throughout the welding process.
2. Remove contaminants from the joint (rust, grease, moisture, etc.) prior to welding.

Corrective Action

1. Grind the weld to sound metal.
2. Weld repair the affected area, if needed.

CRATER PIT

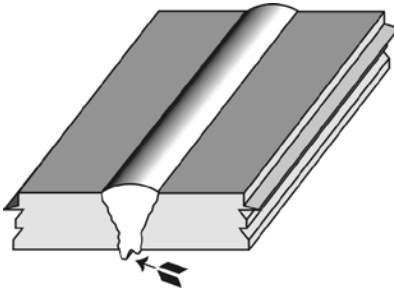
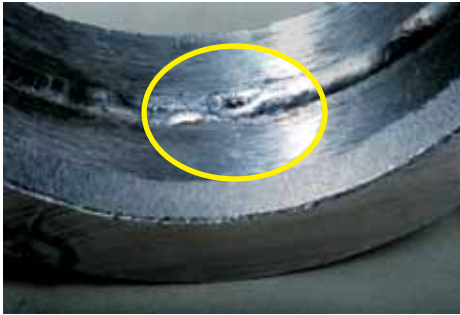

CRATER PIT

Definition

A hole extending into the weld resulting from shrinkage during cooling.

Preventive Action

1. Remove contaminants from the joint (rust, grease, moisture, etc.) prior to welding.
2. When breaking the arc for TIG welding, rapidly pop the trigger several times to avoid sudden pull-offs. This will provide sufficient post purge of the weld puddle.

Corrective Action

1. Grind the weld to sound metal.
2. Weld repair the affected area, if needed.

PAIN



PAINT

Definition

A pigmented oil or liquid that forms a coloring or protective coating when dry. May be found on the weld face or in the weld inspection area.

Preventive Action

Ensure installing trade adequately removes paint, paint stick markings and metal marker writings in the weld zone prior to fitting and welding.

Corrective Action

Grind, wire wheel or needle gun the weld zone free of paint prior to welding.

Types of Weld Joints

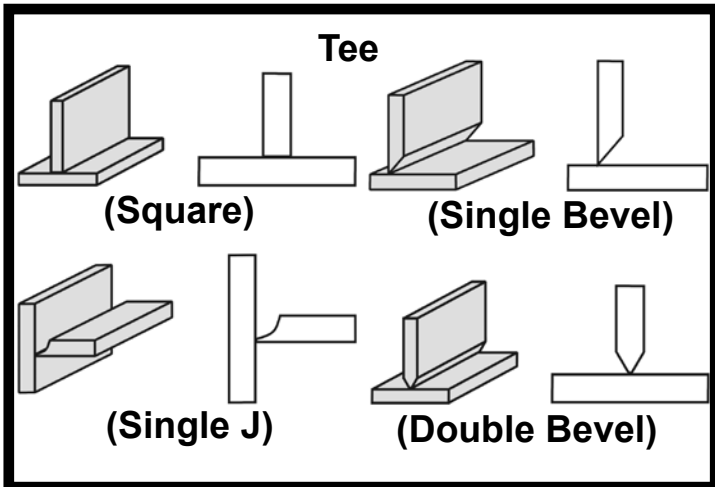
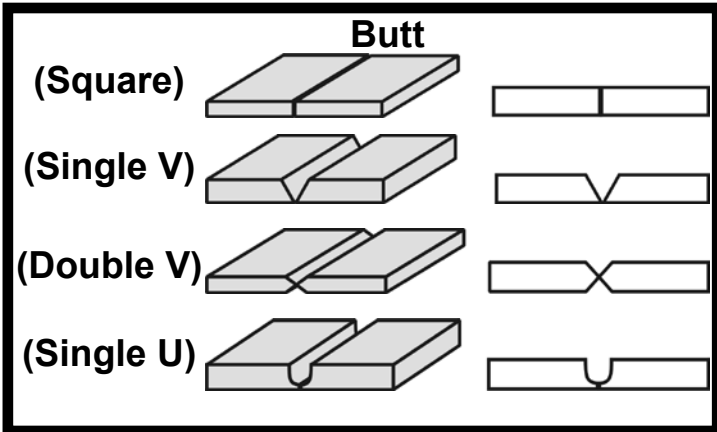

Types of Weld Joints

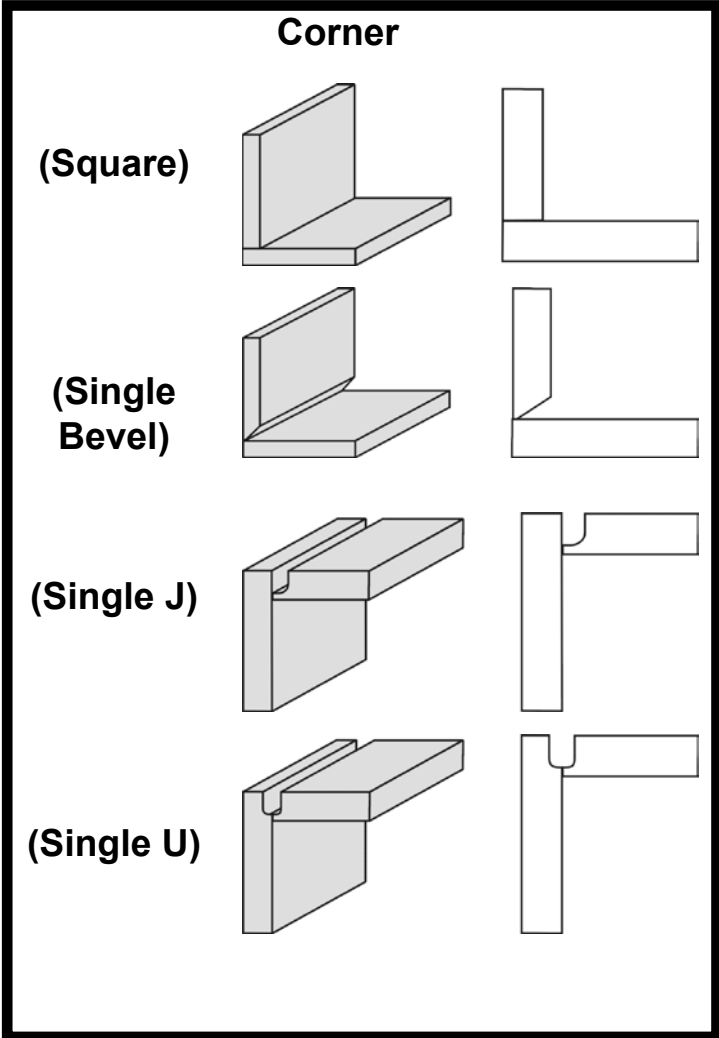

Types of Weld Joints

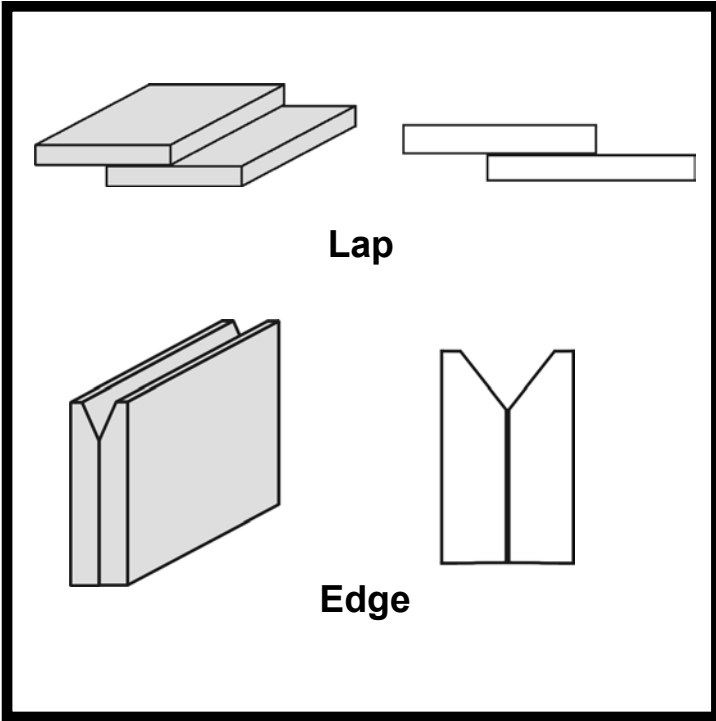

Parts of a Weld

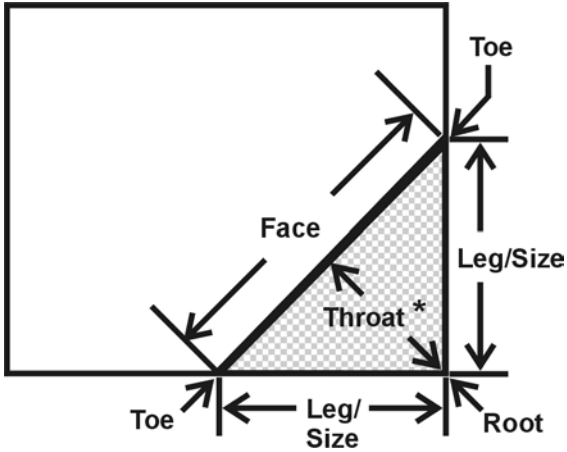

* This represents the theoretical throat (the minimum specified leg size multiplied by 0.7) which is the shortest distance from the joint root to the hypotenuse (straight line drawn toe to toe) of the largest right triangle that can be drawn within the fillet weld cross section.

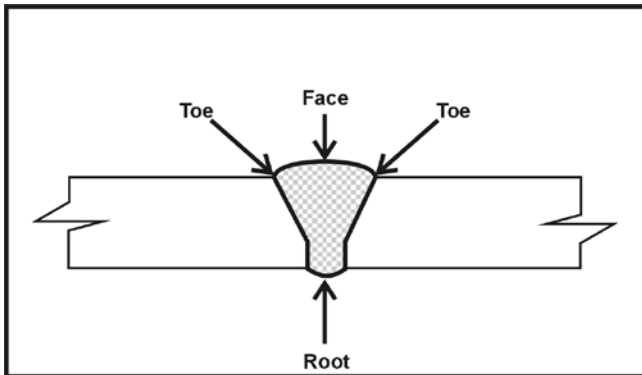

Structural Joint Numbering System

B 2 V . 3

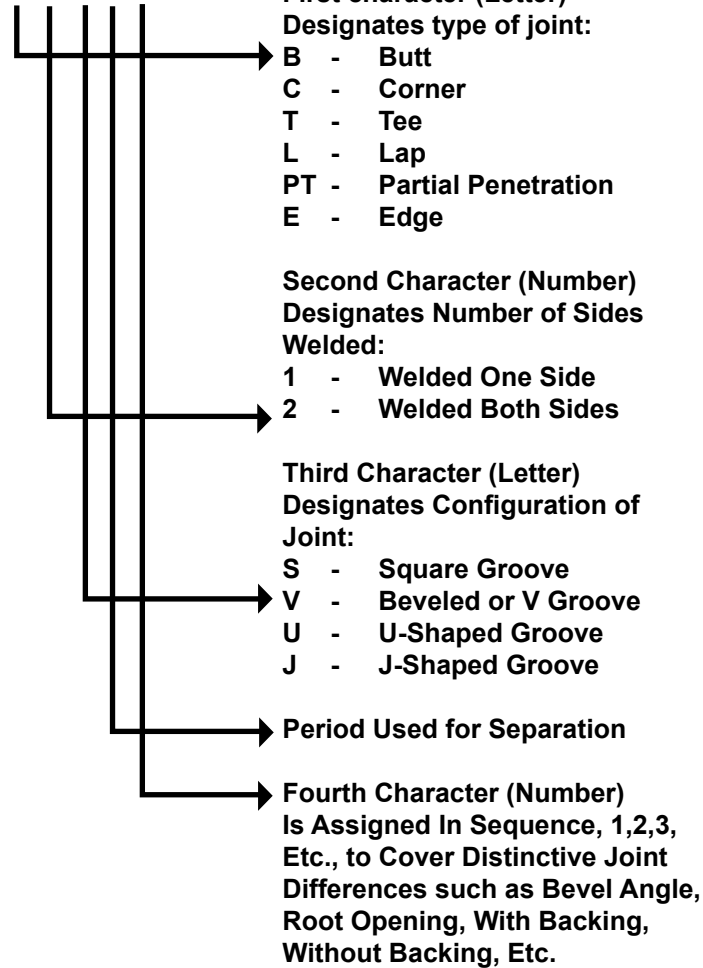

Structural Joint Numbering System EXAMPLES

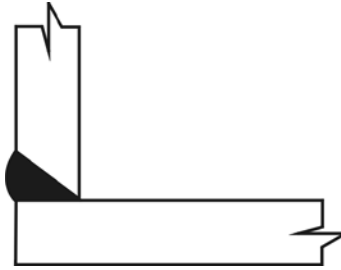

C1V.2

Corner Joint

Single Beveled
Groove

Welded One Side

**Structural Joint
Numbering System
EXAMPLES**

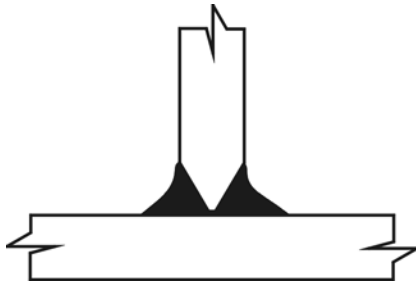

T2V.2

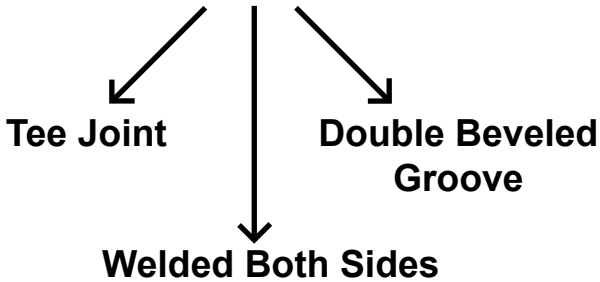

**Structural Joint
Numbering System
EXAMPLES**



B2V.1

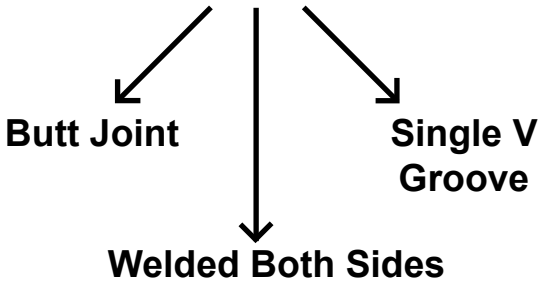

**Structural Joint
Numbering System
EXAMPLES**



B1V.1

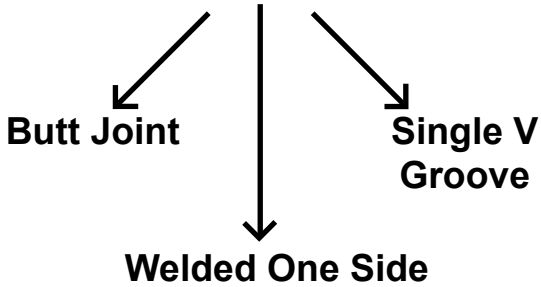

**Structural Joint
Numbering System
EXAMPLES**



B2V.3

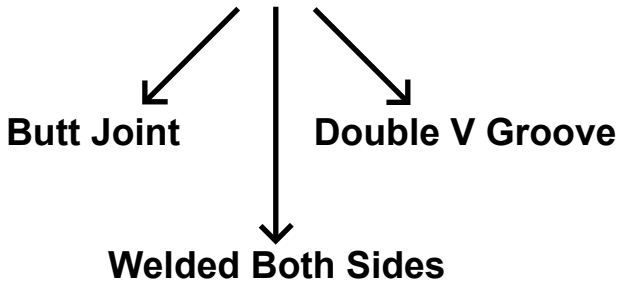

Standard Welding Symbol Layout

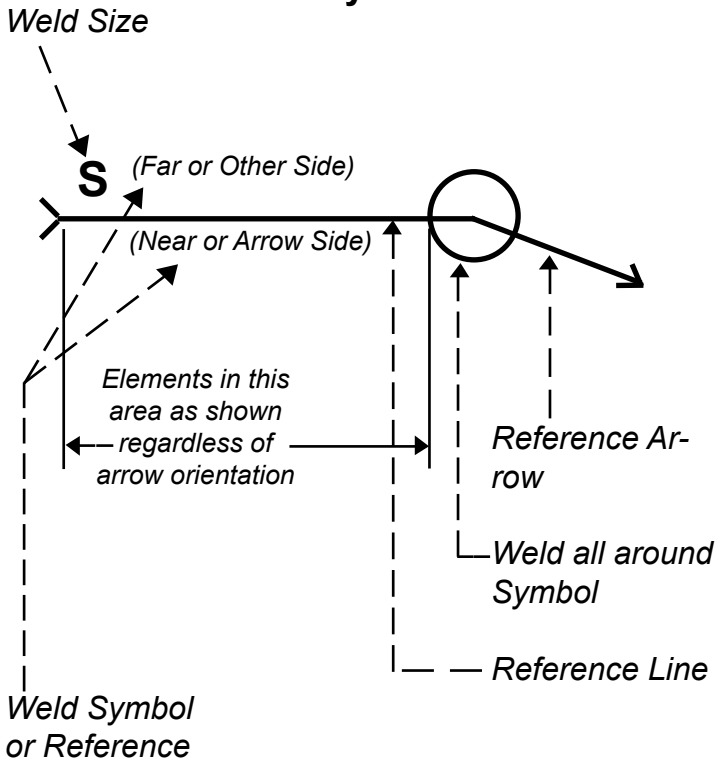

Standard Welding Symbols

Fillet Near Side

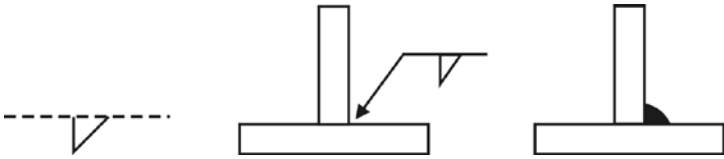

Fillet Far Side

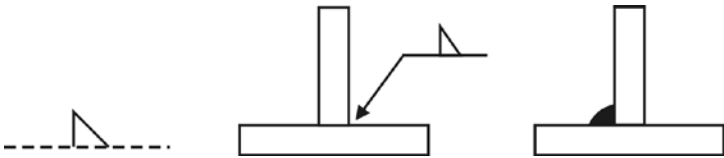

Fillet Both Sides

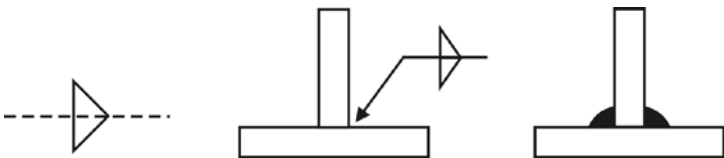

Standard Welding Symbols V Groove Near Side

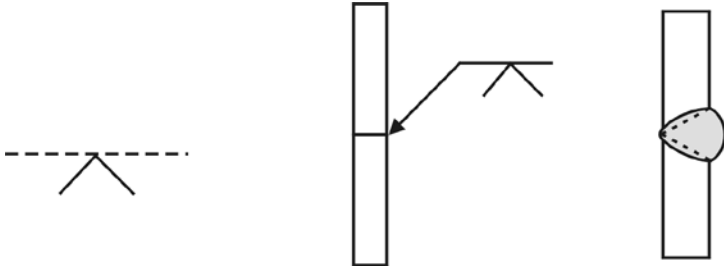

V Groove Far Side

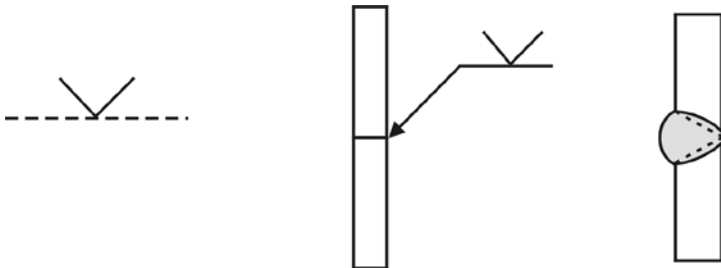

V Groove Both Sides

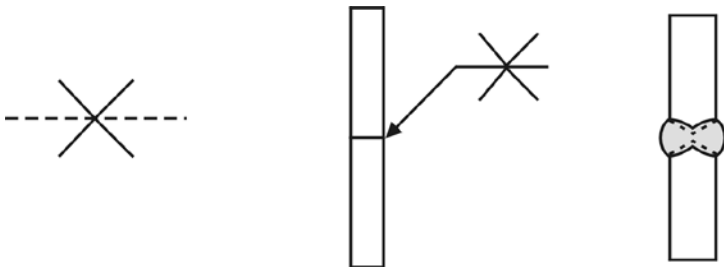

Standard Welding Symbols

Single Bevel Near Side

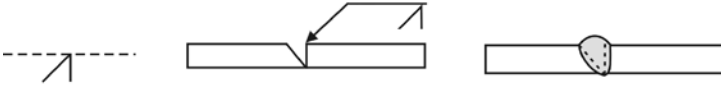

Single Bevel Far Side

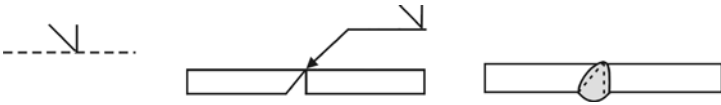

Double Bevel

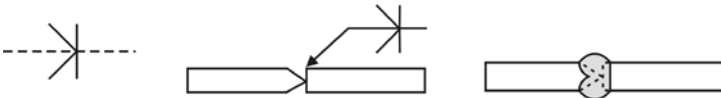

Standard Welding Symbols

Single Beveled Tee Joint Welded One Side / Fillet Reinforced T1V.1

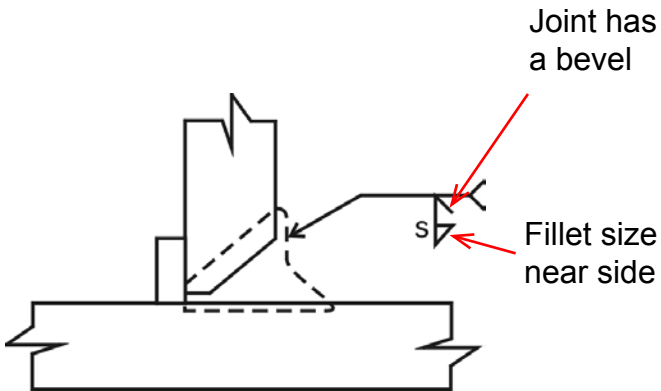

Standard Welding Symbols

Single Beveled Tee Joint Welded Both Sides / Fillet Reinforced T2V.1

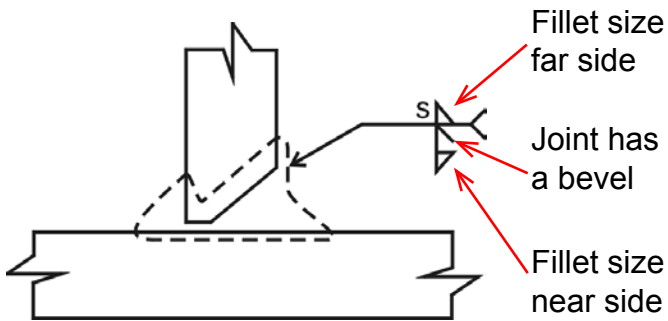

Note: Backgouge and visual inspection required

Standard Welding Symbols
Partial Penetration
Double Bevel Tee Joint
Welded both sides / Fillet Reinforced
Example of PT2V.1

S = fillet size
 B = depth of bevel

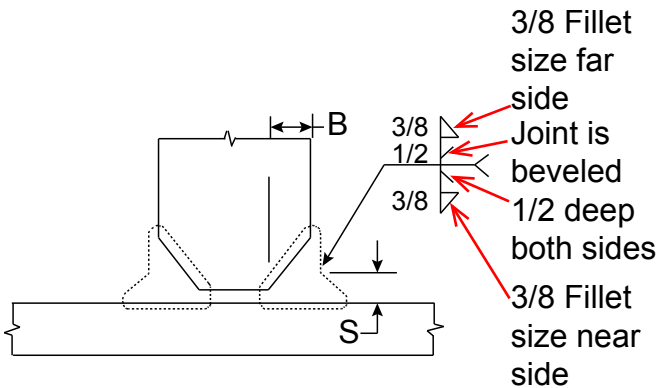
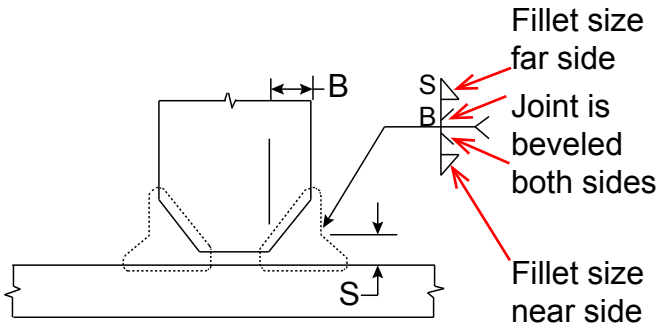

Using Finger Gauge to Measure:

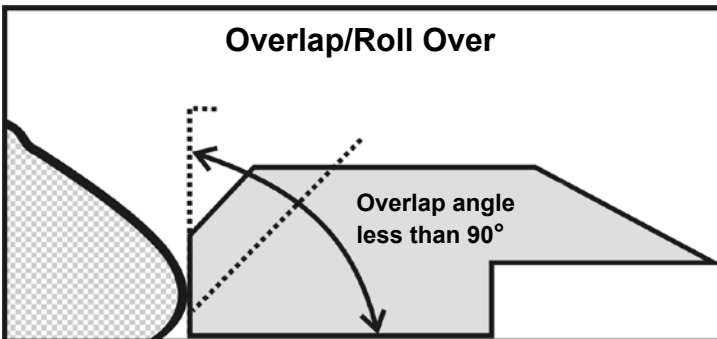
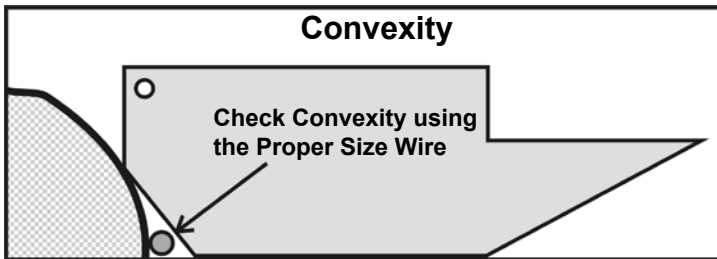
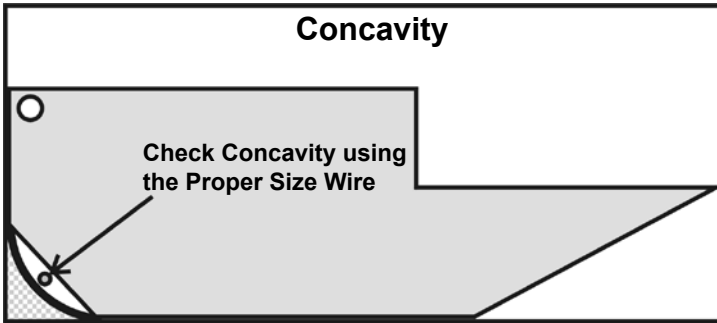

Use Finger Gauge to Measure Skewed Fillet and Fillet Reinforced Welds

Gauging Skewed Welds

Finger gauges are the only gauges capable of gauging skewed welds.

Note that when the angle of the joint preparation is less than 90° the actual length of the weld legs will increase.

TYPICAL RIGHT ANGLE (90°) FILLET WELD

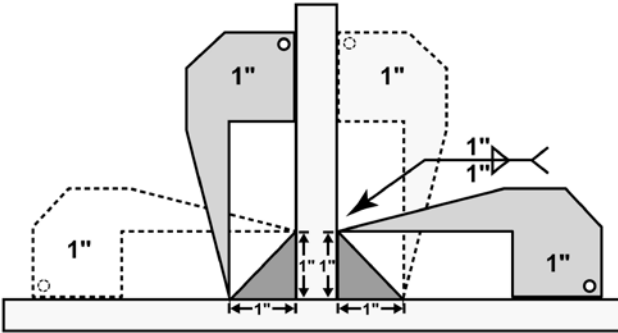

SKEWED/CANTED FILLET WELD

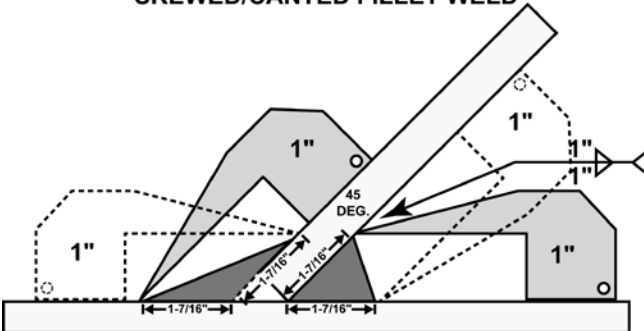

Finger Gauge to Measure Spatter/Slag

A 1/8" wide x 1/8" deep notch is for verifying size of spatter/slag

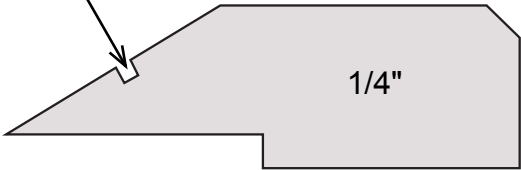

Measuring Slag



Measuring Spatter

Using Bridgecam Gauge To Measure: Fillet Weld Throat

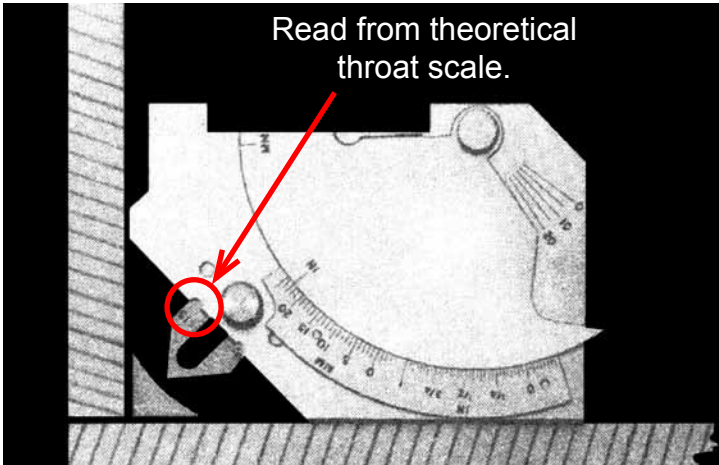

Fillet Leg Length

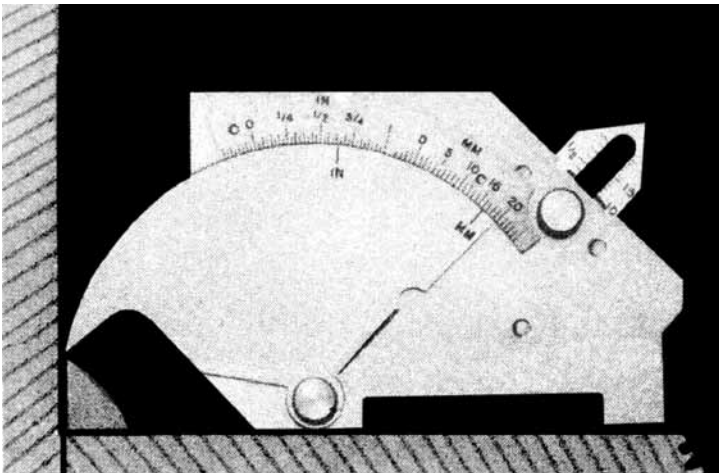

Using Bridgecam Gauge To Measure: Reinforcement

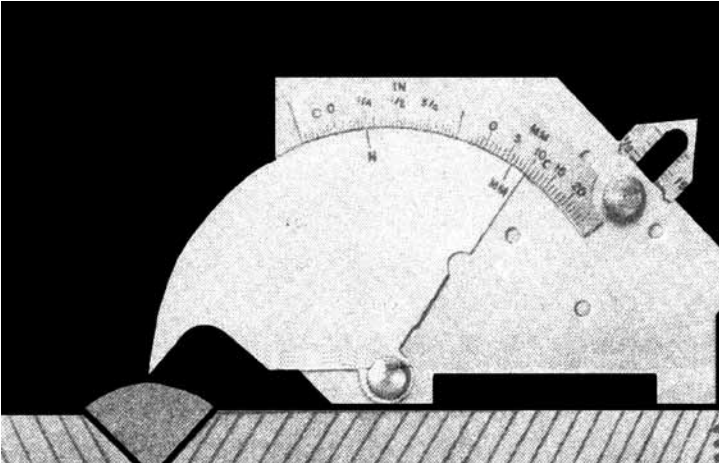

Offset

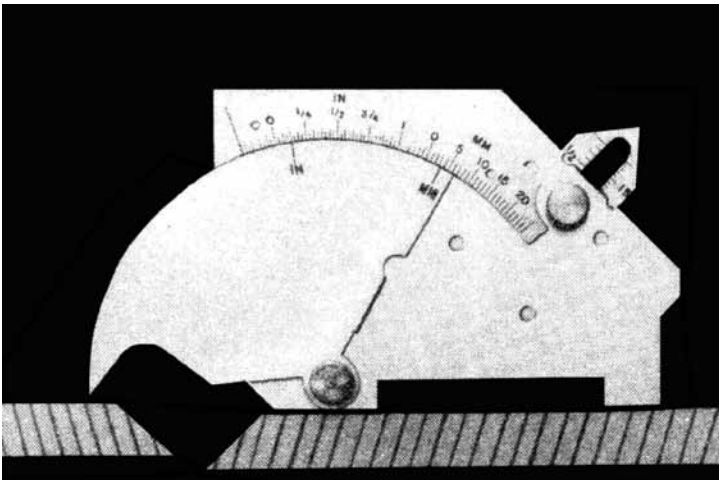

Using Gauges to Measure: Undercut

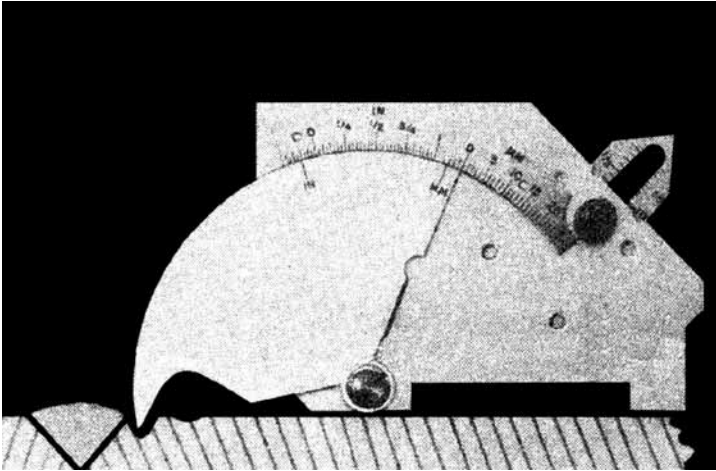

UNDERCUT GAUGE

| | |
|----------------|----------------|
| $\frac{1}{32}$ | $\frac{3}{64}$ |
| $\frac{1}{64}$ | $\frac{1}{16}$ |

Definitions

1. **Completed weld** – A weld that is completed and is ready for final visual inspection.
 2. **Defect** – Any harmful discontinuity that **must** be repaired to be acceptable.
 3. **Discontinuity** – Any imperfection in the normal structure or configuration of a weld or the base material that may or may not need to be repaired.
 4. **Final visual inspection of welds**– Visual inspection performed on a completed weld in the final surface condition and heat-treated condition.
 5. **Finished weld** – A weld that has received final inspection and has been accepted.
 6. **In-process visual inspection of welds**- Visual inspection performed on intermediate passes of multi-pass welds.
 7. **Sound metal** – Metal that contains no defects.
 8. **Skewed fillet welds** - Fillet or fillet reinforced weld that is less than 85° or greater than 95°.
-
- ◆ **NDT** – Nondestructive Testing
 - VT** = Visual Inspection
 - MT** = Magnetic Particle Inspection
 - PT** = Liquid Penetrant Inspection
 - UT** = Ultrasonic Inspection
 - RT** = Radiographic Inspection
 - ET** = Eddy Current Inspection

Scale Divisions Reference

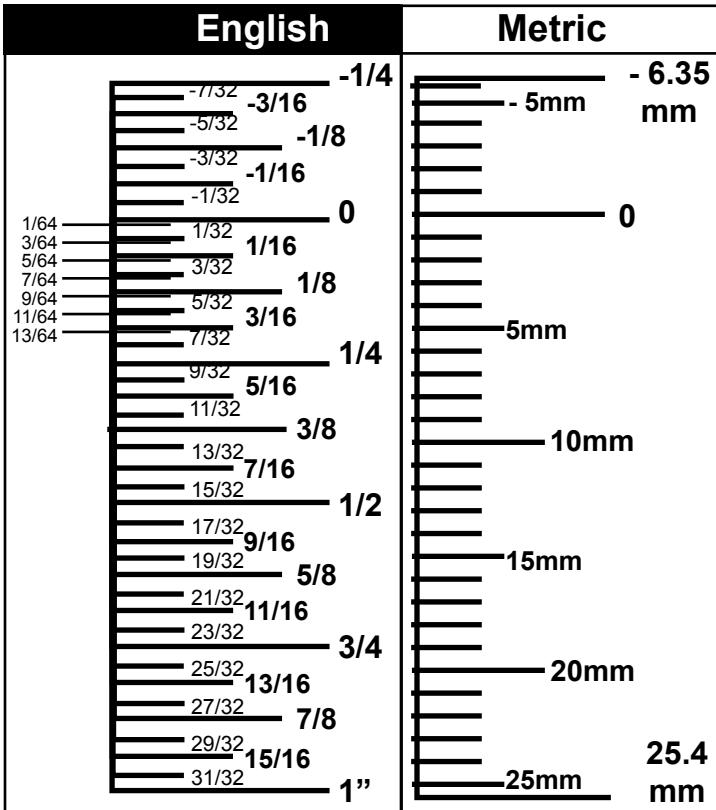

Note: For training purposes only. Not to Scale!